



Lexmark™

# **CS720 Series**

---

## **User's Guide**

**January 2016**

**[www.lexmark.com](http://www.lexmark.com)**

---

Machine type(s):

5028

Model(s):

135, 630

# Contents

- Safety information..... 5**
  - Conventions..... 5
  
- Learning about the printer..... 8**
  - Finding information about the printer.....8
  - Selecting a location for the printer.....9
  - Printer configurations.....10
  - Attaching cables.....11
  - Using the control panel.....12
  - Understanding the status of the power button and indicator light.....13
  - Using the home screen.....13
  - Printing a menu settings page.....14
  - Menus list.....15
  
- Setting up and using the home screen applications..... 16**
  - Customizing the home screen.....16
  - Using Display Customization.....16
  - Setting up Forms and Favorites.....16
  - Configuring Eco-Settings.....17
  
- Loading paper and specialty media.....18**
  - Setting the size and type of the specialty media.....18
  - Configuring Universal paper settings.....18
  - Loading trays.....18
  - Loading the multipurpose feeder.....20
  - Linking trays.....21
  
- Printing.....23**
  - Printing from a computer.....23
  - Printing forms.....23
  - Printing from a flash drive.....23
  - Supported flash drives and file types.....24
  - Configuring confidential jobs.....25
  - Printing held jobs.....25
  - Printing a font sample list.....25

Printing a directory list.....	26
Canceling a print job.....	26

## **Securing the printer.....27**

Erasing printer memory.....	27
Erasing printer hard disk memory.....	27
Configuring printer hard disk encryption.....	27
Restoring factory default settings.....	27
Statement of Volatility.....	28

## **Maintaining the printer..... 29**

Networking.....	29
Connecting the printer to a wireless network using Wi-Fi Protected Setup (WPS).....	29
Changing port settings after installing an internal solutions port.....	30
Setting up serial printing (Windows only).....	30
Cleaning the printer.....	31
Ordering supplies.....	31
Checking the status of parts and supplies .....	31
Using genuine Lexmark parts and supplies .....	31
Ordering toner cartridges .....	32
Ordering imaging unit or imaging kit .....	32
Ordering a waste toner bottle.....	33
Ordering a fuser maintenance kit .....	33
Ordering a transfer module .....	33
Replacing parts and supplies.....	34
Replacing the imaging unit .....	34
Replacing the imaging kit.....	38
Replacing a toner cartridge .....	42
Replacing the waste toner bottle .....	43
Replacing the fuser .....	44
Replacing the pick roller.....	46
Replacing the separator bracket.....	48
Replacing the transfer module.....	50
Resetting the maintenance counter .....	54
Moving the printer.....	54
Moving the printer to another location .....	54
Shipping the printer .....	54
Saving energy and paper.....	55
Setting up power saver modes.....	55
Adjusting the brightness of printer display.....	55
Conserving supplies .....	55

Recycling..... 55  
    Recycling Lexmark products ..... 55  
    Recycling Lexmark packaging ..... 56  
    Returning Lexmark cartridges for reuse or recycling ..... 56

**Clearing jams.....57**

Avoiding jams..... 57  
Identifying jam locations..... 58  
Paper jam in trays..... 59  
Paper jam in the multipurpose feeder..... 60  
Paper jam in the standard bin..... 60  
Paper jam in door A..... 61

**Troubleshooting.....65**

Network connection problems..... 65  
Hardware options problems..... 67  
Paper feed problems..... 69  
Printing problems..... 72  
Color quality problems..... 90  
Contacting customer support..... 93

**Upgrading and migrating..... 94**

Hardware..... 94  
    Available internal options..... 94  
    Installing a memory card ..... 94  
    Installing an internal solutions port..... 96  
    Installing an optional card .....101  
    Installing a printer hard disk .....103  
    Installing optional trays .....107  
Software..... 108  
    Installing the printer software.....108  
    Adding available options in the print driver .....108  
Firmware..... 108  
    Exporting or importing a configuration file .....108  
    Updating firmware.....109

**Notices..... 110**

**Index..... 114**

# Safety information













## Conventions









**Note:** A *note* identifies information that could help you.

**Warning:** A *warning* identifies something that could damage the product hardware or software.

**CAUTION:** A *caution* indicates a potentially hazardous situation that could injure you.

Different types of caution statements include:

-  **CAUTION—POTENTIAL INJURY:** Indicates a risk of injury.
-  **CAUTION—SHOCK HAZARD:** Indicates a risk of electrical shock.
-  **CAUTION—HOT SURFACE:** Indicates a risk of burn if touched.
-  **CAUTION—TIPPING HAZARD:** Indicates a crush hazard.
-  **CAUTION—POTENTIAL INJURY:** To avoid the risk of fire or electrical shock, connect the power cord to an appropriately rated and properly grounded electrical outlet that is near the product and easily accessible.
-  **CAUTION—POTENTIAL INJURY:** To avoid the risk of fire or electrical shock, use only the power cord provided with this product or the manufacturer's authorized replacement.
-  **CAUTION—POTENTIAL INJURY:** Do not use this product with extension cords, multioutlet power strips, multioutlet extenders, or UPS devices. The power capacity of these types of accessories can be easily overloaded by a laser printer and may result in a risk of fire, property damage, or poor printer performance.
-  **CAUTION—POTENTIAL INJURY:** Only a Lexmark Inline Surge Protector that is properly connected between the printer and the power cord provided with the printer may be used with this product. The use of non-Lexmark surge protection devices may result in a risk of fire, property damage, or poor printer performance.
-  **CAUTION—SHOCK HAZARD:** To avoid the risk of electrical shock, do not place or use this product near water or wet locations.
-  **CAUTION—SHOCK HAZARD:** To avoid the risk of electrical shock, do not set up this product or make any electrical or cabling connections, such as the power cord, fax feature, or telephone, during a lightning storm.
-  **CAUTION—POTENTIAL INJURY:** Do not cut, twist, bind, crush, or place heavy objects on the power cord. Do not subject the power cord to abrasion or stress. Do not pinch the power cord between objects such as furniture and walls. If any of these things happen, a risk of fire or electrical shock results. Inspect the power cord regularly for signs of such problems. Remove the power cord from the electrical outlet before inspecting it.
-  **CAUTION—SHOCK HAZARD:** To avoid the risk of electrical shock, make sure that all external connections (such as Ethernet and telephone system connections) are properly installed in their marked plug-in ports.

-  **CAUTION—SHOCK HAZARD:** To avoid the risk of electrical shock, if you are accessing the controller board or installing optional hardware or memory devices sometime after setting up the printer, then turn the printer off, and unplug the power cord from the electrical outlet before continuing. If you have any other devices attached to the printer, then turn them off as well, and unplug any cables going into the printer.
-  **CAUTION—SHOCK HAZARD:** To avoid the risk of electrical shock when cleaning the exterior of the printer, unplug the power cord from the electrical outlet and disconnect all cables from the printer before proceeding.
-  **CAUTION—POTENTIAL INJURY:** The printer weight is greater than 18 kg (40 lb) and requires two or more trained personnel to lift it safely.
-  **CAUTION—POTENTIAL INJURY:** When moving the printer, follow these guidelines to avoid personal injury or printer damage:
- Make sure that all doors and trays are closed.
  - Turn off the printer, and then unplug the power cord from the electrical outlet.
  - Disconnect all cords and cables from the printer.
  - If the printer has a caster base, then carefully roll it to the new location. Use caution when passing over thresholds and breaks in flooring.
  - If the printer does not have a caster base but is configured with optional trays, then lift the printer off the trays. Do not try to lift the printer and the trays at the same time.
  - Always use the handholds on the printer to lift it.
  - Any cart used to move the printer must have a surface able to support the full footprint of the printer.
  - Any cart used to move the hardware options must have a surface able to support the dimensions of the options.
  - Keep the printer in an upright position.
  - Avoid severe jarring movements.
  - Make sure that your fingers are not under the printer when you set it down.
  - Make sure that there is adequate clearance around the printer.
-  **CAUTION—TIPPING HAZARD:** Installing one or more options on your printer or MFP may require a caster base, furniture, or other feature to prevent instability causing possible injury. For more information on supported configurations, see [www.lexmark.com/multifunctionprinters](http://www.lexmark.com/multifunctionprinters).
-  **CAUTION—TIPPING HAZARD:** To reduce the risk of equipment instability, load each tray separately. Keep all other trays closed until needed.
-  **CAUTION—HOT SURFACE:** The inside of the printer might be hot. To reduce the risk of injury from a hot component, allow the surface to cool before touching it.
-  **CAUTION—POTENTIAL INJURY:** This product uses a laser. Use of controls or adjustments or performance of procedures other than those specified in the *User's Guide* may result in hazardous radiation exposure.
-  **CAUTION—POTENTIAL INJURY:** The lithium battery in this product is not intended to be replaced. There is a danger of explosion if a lithium battery is incorrectly replaced. Do not recharge, disassemble, or incinerate a lithium battery. Discard used lithium batteries according to the manufacturer's instructions and local regulations.

This equipment is not suitable for use in locations where children are likely to be present.

This product is designed, tested, and approved to meet strict global safety standards with the use of specific manufacturer's components. The safety features of some parts may not always be obvious. The manufacturer is not responsible for the use of other replacement parts.

Refer service or repairs, other than those described in the user documentation, to a service representative.

This product uses a printing process that heats the print media, and the heat may cause the media to release emissions. You must understand the section in your operating instructions that discusses the guidelines for selecting print media to avoid the possibility of harmful emissions.

This product may produce small amounts of ozone during normal operation, and may be equipped with a filter designed to limit ozone concentrations to levels well below the recommended exposure limits. To avoid high ozone concentration levels during extensive usage, install this product in a well-ventilated area and replace the ozone and exhaust filters if instructed to do so in the product maintenance instructions. If there are no references to filters in the product maintenance instructions, then there are no filters requiring replacement for this product.

**SAVE THESE INSTRUCTIONS.**

# Learning about the printer

## Finding information about the printer

What are you looking for?	Find it here
Initial setup instructions: <ul style="list-style-type: none"> <li>• Connecting the printer</li> <li>• Installing the printer software</li> </ul>	Setup documentation—The setup documentation came with the printer and is also available at <a href="http://support.lexmark.com">http://support.lexmark.com</a> .
Additional setup and instructions for using the printer: <ul style="list-style-type: none"> <li>• Selecting and storing paper and specialty media</li> <li>• Loading paper</li> <li>• Configuring printer settings</li> <li>• Viewing and printing documents and photos</li> <li>• Setting up and using the printer software</li> <li>• Configuring the printer on a network</li> <li>• Caring for and maintaining the printer</li> <li>• Troubleshooting and solving problems</li> </ul>	<i>Information Center</i> —Authoritative online resource for the latest product tips, instructions, and reference material. Go to <a href="http://infoserve.lexmark.com/ids/">http://infoserve.lexmark.com/ids/</a> and select your product. <i>Help Menu Pages</i> —The guides may be available on the printer firmware and at <a href="http://support.lexmark.com">http://support.lexmark.com</a> .
Information on setting up and configuring the accessibility features of your printer	<i>Lexmark Accessibility Guide</i> —The guide is available at <a href="http://support.lexmark.com">http://support.lexmark.com</a> .
Help using the printer software	Help for Microsoft® Windows® or Macintosh operating systems—Open a printer software program or application, and then click <b>Help</b> . Click  to view context-sensitive information. <b>Notes:</b> <ul style="list-style-type: none"> <li>• Help is automatically installed with the printer software.</li> <li>• The printer software is located in the printer program folder or on the desktop, depending on the operating system.</li> </ul>





What are you looking for?	Find it here
<p>The latest supplemental information, updates, and customer support:</p> <ul style="list-style-type: none"> <li>• Documentation</li> <li>• Driver downloads</li> <li>• Live chat support</li> <li>• E-mail support</li> <li>• Voice support</li> </ul>	<p><a href="http://support.lexmark.com">http://support.lexmark.com</a></p> <p><b>Note:</b> Select your country or region, and then select your product to view the appropriate support site.</p> <p>Support contact information for your country or region can be found on the support Web site or on the printed warranty that came with the printer.</p> <p>Have the following information (located on the store receipt and at the back of the printer) ready when you contact customer support:</p> <ul style="list-style-type: none"> <li>• Machine type number</li> <li>• Serial number</li> <li>• Date purchased</li> <li>• Store where purchased</li> </ul>
<ul style="list-style-type: none"> <li>• Safety information</li> <li>• Regulatory information</li> <li>• Warranty information</li> </ul>	<p>Warranty information varies by country or region:</p> <ul style="list-style-type: none"> <li>• <b>In the U.S.</b>—See the Statement of Limited Warranty included with the printer, or go to <a href="http://support.lexmark.com">http://support.lexmark.com</a>.</li> <li>• <b>In other countries and regions</b>—See the printed warranty that came with the printer.</li> </ul> <p><i>Product Information Guide</i>—This document contains basic safety, environmental, and regulatory information for your product. For more information, see the documentation that came with the printer or go to <a href="http://support.lexmark.com">http://support.lexmark.com</a>.</p>

## Selecting a location for the printer

When selecting a location for the printer, leave enough room to open trays, covers, and doors and to install hardware options.

- Set up the printer near an electrical outlet.

 **CAUTION—POTENTIAL INJURY:** To avoid the risk of fire or electrical shock, connect the power cord to an appropriately rated and properly grounded electrical outlet that is near the product and easily accessible.

 **CAUTION—SHOCK HAZARD:** To avoid the risk of electrical shock, do not place or use this product near water or wet locations.

- Make sure that airflow in the room meets the latest revision of the ASHRAE 62 standard or the CEN Technical Committee 156 standard.
- Provide a flat, sturdy, and stable surface.
- Keep the printer:
  - Clean, dry, and free of dust.
  - Away from stray staples and paper clips.
  - Away from the direct airflow of air conditioners, heaters, or ventilators.
  - Free from direct sunlight and humidity extremes.

- Observe the recommended temperatures and avoid fluctuations:

Ambient temperature	10 to 32.2°C (50 to 90°F)
Storage temperature	-40 to 43°C (-40 to 110°F)

- Allow the following recommended amount of space around the printer for proper ventilation:

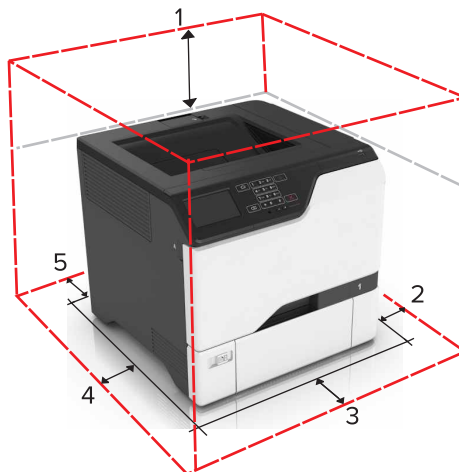

<b>1</b>	Top	178 mm (7 in.)
<b>2</b>	Right side	127 mm (5 in.)
<b>3</b>	Front	508 mm (20 in.)
<b>4</b>	Left side	127 mm (5 in.)
<b>5</b>	Rear	76 mm (3 in.)

## Printer configurations

**CAUTION—TIPPING HAZARD:** Installing one or more options on your printer or MFP may require a caster base, furniture, or other feature to prevent instability causing possible injury. For more information on supported configurations, see [www.lexmark.com/multifunctionprinters](http://www.lexmark.com/multifunctionprinters).

**CAUTION—TIPPING HAZARD:** To reduce the risk of equipment instability, load each tray separately. Keep all other trays closed until needed.

You can configure your printer by adding three optional 550-sheet trays.



1	Standard bin
2	650-sheet duo tray
3	Optional 550-sheet trays
4	Control panel

## Attaching cables

**⚡ CAUTION—SHOCK HAZARD:** To avoid the risk of electrical shock, do not set up this product or make any electrical or cabling connections, such as the power cord, fax feature, or telephone, during a lightning storm.

**⚠ CAUTION—POTENTIAL INJURY:** To avoid the risk of fire or electrical shock, connect the power cord to an appropriately rated and properly grounded electrical outlet that is near the product and easily accessible.

**⚠ CAUTION—POTENTIAL INJURY:** To avoid the risk of fire or electrical shock, use only the power cord provided with this product or the manufacturer's authorized replacement.

**Warning—Potential Damage:** Do not touch the USB cable, any wireless network adapter, or the printer in the area shown while actively printing. Loss of data or a malfunction can occur.

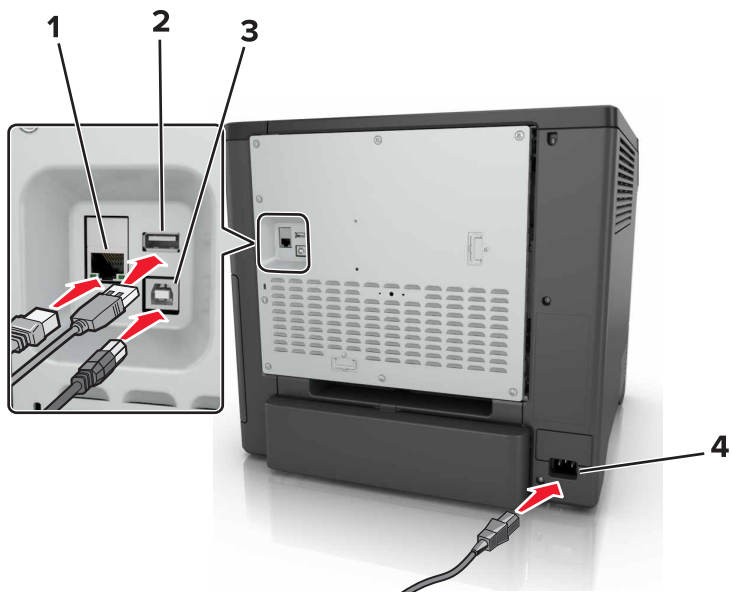

	Use the	To
1	Ethernet port	Connect the printer to a network.
2	USB port	Attach a keyboard or any compatible option.
3	USB printer port	Connect the printer to a computer.
4	Printer power cord socket	Connect the printer to a properly grounded electrical outlet.

## Using the control panel

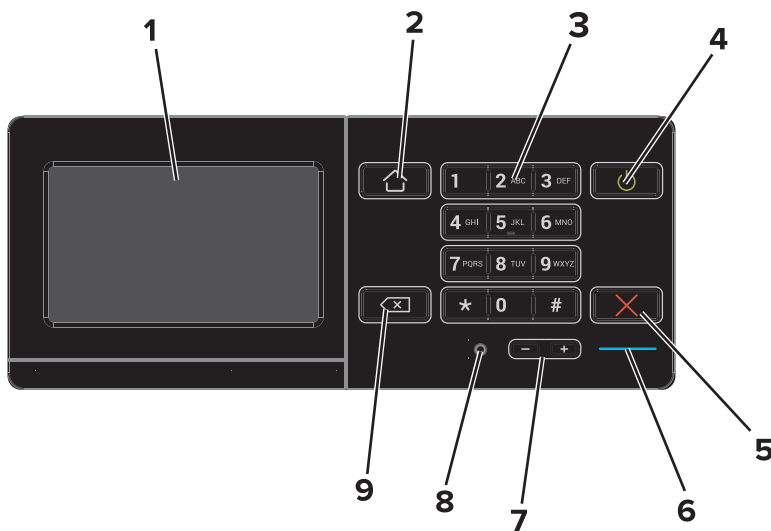

	Use the	To
1	Display	<ul style="list-style-type: none"> <li>View the printer messages and supply status.</li> <li>Set up and operate the printer.</li> </ul>

	Use the	To
2	Home button	Go to the home screen.
3	Keypad	Enter numbers or symbols in an input field.
4	Power button	<ul style="list-style-type: none"> <li>Turn on or turn off the printer.</li> </ul> <p><b>Note:</b> To turn off the printer, press and hold the power button for five seconds.</p> <ul style="list-style-type: none"> <li>Set the printer to Sleep or Hibernate mode.</li> <li>Wake the printer from Sleep or Hibernate mode.</li> </ul>
5	Stop or Cancel button	Stop the current job.
6	Indicator light	Check the status of the printer.
7	Volume buttons	Adjust the volume of the headset or speaker.
8	Headset or speaker port	Attach a headset or speaker.
9	Backspace button	Move the cursor backward and delete a character in an input field.

## Understanding the status of the power button and indicator light

Indicator light	Printer status
Off	The printer is off or in Hibernate mode.
Blue	The printer is ready or processing data.
Red	The printer requires user intervention.

  

Power button light	Printer status
Off	The printer is off, ready, or processing data.
Solid amber	The printer is in sleep mode.
Blinking amber	The printer is in hibernate mode.

## Using the home screen

When the printer is turned on, the display shows the home screen. Use the home screen buttons and icons to initiate an action.

**Note:** Your home screen may vary depending on your home screen customization settings, administrative setup, and active embedded solutions.

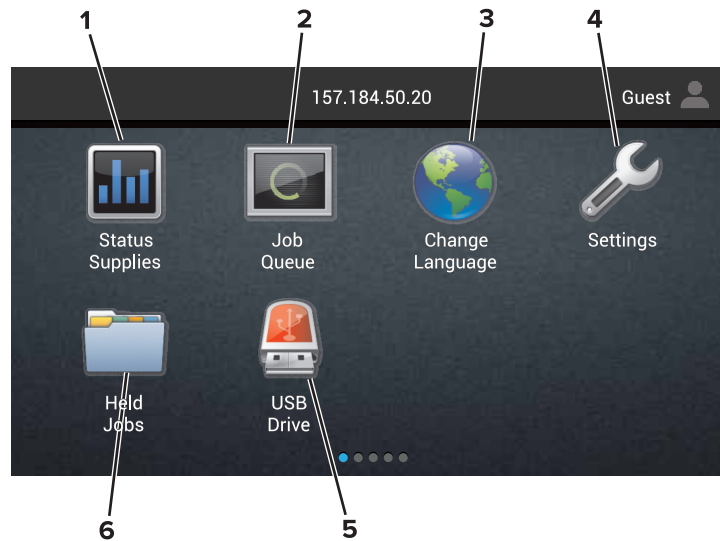

Touch		To
1	Status/Supplies	<ul style="list-style-type: none"> <li>Show a printer warning or error message whenever the printer requires intervention to continue processing.</li> <li>View more information on the printer warning or message, and on how to clear it.</li> </ul> <p><b>Note:</b> You can also access this setting by touching the top section of the home screen.</p>
2	Job Queue	Show all the current print jobs. <b>Note:</b> You can also access this setting by touching the top section of the home screen.
3	Change Language	Change the language on the printer display.
4	Settings	Access the printer menus.
5	USB Drive	View, select, or print photos and documents from a flash drive.
6	Held Jobs	Show all the current held print jobs.

**These settings may also appear on the home screen**

Touch	To
Bookmarks	Access bookmarks.
App Profiles	Access application profiles.
Lock Device	Prevent users from accessing any printer functions from the home screen.

## Printing a menu settings page

From the home screen, touch **Settings > Reports > Menu Settings Page**.

## Menu list

Device	Print	Paper	Network/Ports	USB Drive
Preferences	Layout	Tray Configuration	Network Overview	Flash Drive Print
Notifications	Setup	Media Configuration	Wireless	
Group Lists	Quality	Bin Configuration	AirPrint	
Alert Types	Job Accounting		Ethernet	
Anti-Spam Logic Description	Image		TCP/IP	
Suppressing Duplicate Alerts	XPS		IPv6	
Power Management	PDF		SNMP	
Information Sent to Lexmark	HTML		802.1x	
Accessibility	PostScript		IPSec	
Restore Factory Defaults	PCL		LPD Configuration	
Maintenance	PPDS		HTTP/FTP Settings	
Remote Operator Panel			ThinPrint	
Visible Home Screen Icons			USB	
Site Map			Parallel [x]	
Update Firmware			Serial	
About This Printer			Wi-Fi Direct	
<b>Security</b>	<b>Option Card Menu</b>	<b>Reports</b>	<b>Help</b>	
Login Methods	<b>Note:</b> This setting appears only when an optional card is installed.	Menu Settings Page	Print All Guides	
Certificate Management		Print Quality Pages	Color Quality Guide	
Schedule USB Devices		Device	Connection Guide	
Security Audit Log		Print	Information Guide	
Login Restrictions		Shortcuts	Media Guide	
Confidential Print Setup		Network	Moving Guide	
Disk Encryption			Print Quality Guide	
Erase Temporary Data Files			Supplies Guide	
Solutions LDAP Settings				
Miscellaneous				

# Setting up and using the home screen applications

## Customizing the home screen

- 1 Open a Web browser, and then type the printer IP address in the address field.

**Notes:**

- View the printer IP address on the printer home screen. The IP address appears as four sets of numbers separated by periods, such as 123.123.123.123.
- If you are using a proxy server, then temporarily disable it to load the Web page correctly.

- 2 Click **Settings > Device > Visible Home Screen Icons**.
- 3 Select the icons that you want to appear on the home screen.
- 4 Apply the changes.

## Using Display Customization

- 1 From the home screen, touch **Change Background**.
- 2 Select a background to use.
- 3 Apply the changes.

## Setting up Forms and Favorites

- 1 Open a Web browser, and then type the printer IP address in the address field.

**Notes:**

- View the printer IP address on the printer home screen. The IP address appears as four sets of numbers separated by periods, such as 123.123.123.123.
- If you are using a proxy server, then temporarily disable it to load the Web page correctly.

- 2 Click **Apps > Forms and Favorites > Configure**.
- 3 Click **Add**, and then customize the settings.

**Notes:**

- To make sure that the location settings of the bookmark are correct, type the IP address of the host computer where the bookmark is located.
- Make sure that the printer has access rights to the folder where the bookmark is located.

- 4 Apply the changes.



## Configuring Eco-Settings

- 1 From the home screen, touch **Eco-Settings**.
- 2 Configure the settings.
- 3 Apply the changes.

# Loading paper and specialty media

## Setting the size and type of the specialty media

The trays automatically detect the size of plain paper. For specialty media like labels, card stock, or envelopes, do the following:

- 1 From the home screen, navigate to:  
**Settings > Paper > Tray Configuration** > select a tray
- 2 Configure the size and type of the specialty media.

## Configuring Universal paper settings

- 1 From the home screen, touch **Settings > Paper > Media Configuration > Universal Setup**.
- 2 Configure the settings.

## Loading trays

**CAUTION—TIPPING HAZARD:** To reduce the risk of equipment instability, load each tray separately. Keep all other trays closed until needed.

- 1 Remove the tray.

**Note:** To avoid jams, do not remove trays while the printer is busy.

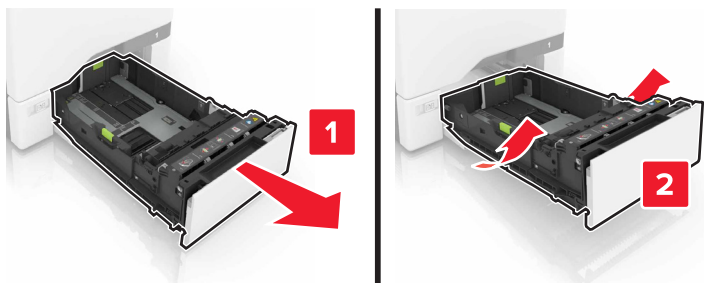

- 2 Adjust the guides to match the size of the paper you are loading.

**Note:** Use the indicators on the bottom of the tray to position the guides.

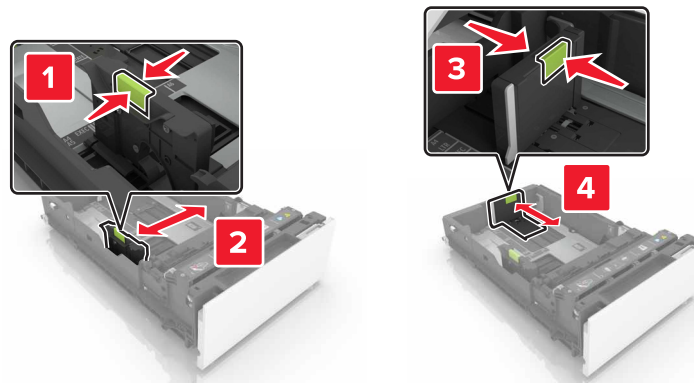

**3** Flex, fan, and align the paper edges before loading.

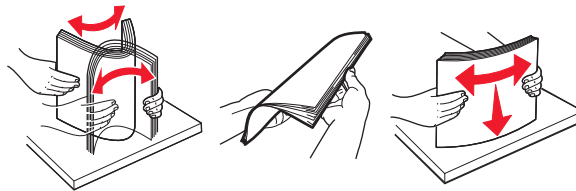

**4** Load the paper stack with the printable side faceup.

**Notes:**

- For one-sided printing, load letterhead faceup with the header toward the front of the tray.
- For two-sided printing, load letterhead facedown with the header toward the back of the tray.
- Do not slide paper into the tray.
- Make sure that the stack height is below the maximum paper fill indicator. Overfilling may cause paper jams.

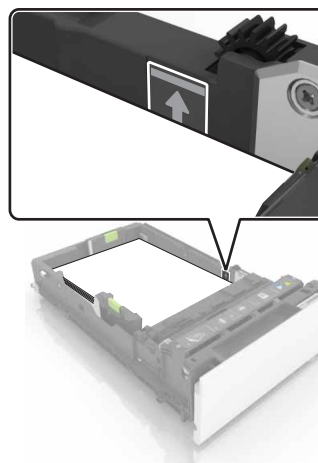

**5** Insert the tray.

If necessary, set the paper size and type to match the paper loaded in the tray.

## Loading the multipurpose feeder

- 1 Open the multipurpose feeder.

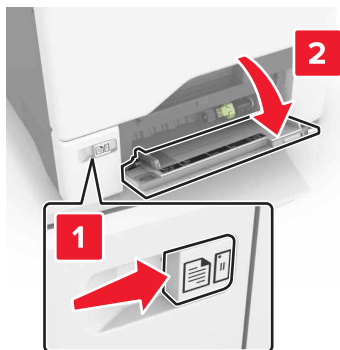

- 2 Adjust the guide to match the size of the paper you are loading.



- 3 Flex, fan, and align the paper edges before loading.

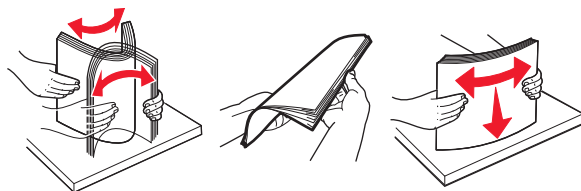

#### 4 Load the paper.

- Load paper and card stock with the printable side facedown and the top edge entering the printer first.



- Load envelopes with the flap side up and against the right side of the paper guide. Load European envelopes with the flap entering the printer first.

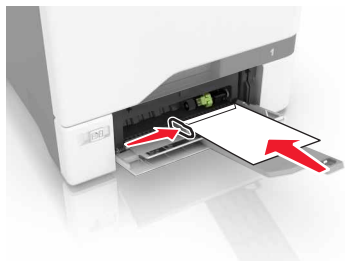

**Warning—Potential Damage:** Do not use envelopes with stamps, clasps, snaps, windows, coated linings, or self-stick adhesives.

- 5 From the Paper Menu in the control panel, set the paper size and type to match the paper loaded in the tray.

## Linking trays

- 1 Open a Web browser, and then type the printer IP address in the address field.

**Notes:**

- View the printer IP address on the printer home screen. The IP address appears as four sets of numbers separated by periods, such as 123.123.123.123.
- If you are using a proxy server, then temporarily disable it to load the Web page correctly.

- 2 Click **Settings > Paper**.

**3** Match the paper size and type for the trays you are linking.

**Note:** To unlink trays, make sure that no trays have the same paper size or type.

**4** Save the settings.

**Note:** You can also change the paper size and type settings from the printer control panel.

**Warning—Potential Damage:** The temperature of the fuser varies according to the specified paper type. To avoid printing issues, match the paper type settings in the printer with the paper loaded in the tray.

# Printing

## Printing from a computer

**Note:** For specialty media such as labels, card stock, and envelopes, set the paper size and type in the printer before sending the print job.

- 1 With a document open, click **File > Print**.
- 2 If necessary, adjust the settings.
- 3 Send the print job.

## Printing forms

- 1 From the home screen, navigate to:  
**Forms and Favorites > select form > Print**
- 2 If necessary, configure the print settings.
- 3 Send the print job.

## Printing from a flash drive

- 1 Insert a flash drive into the USB port.

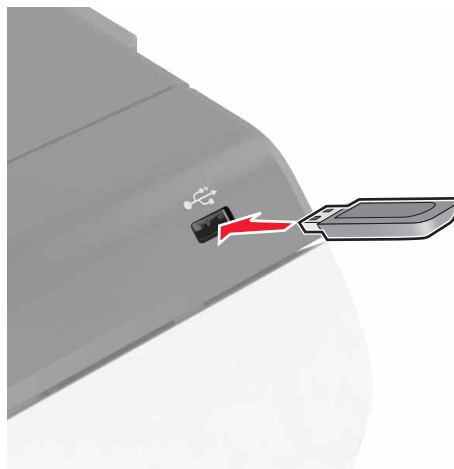

### Notes:

- If you insert the flash drive when an error message appears, then the printer ignores the flash drive.
  - If you insert the flash drive while the printer is processing other print jobs, then **Busy** appears on the display.
- 2 From the display, touch the document that you want to print.  
If necessary, configure other print settings.

### 3 Send the print job.

To print another document, touch **USB Drive**.

**Warning—Potential Damage:** Do not touch the printer or the flash drive in the area shown while actively printing, reading, or writing from the memory device. Loss of data or a malfunction can occur.

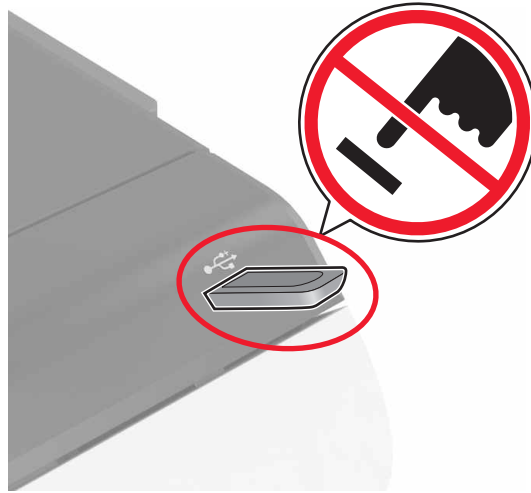

## Supported flash drives and file types

### Flash drives

- Lexar JumpDrive S70 (16GB and 32GB)
- SanDisk Cruzer (16GB and 32GB)
- PNY Attaché (16GB and 32GB)

### Notes:

- The printer supports high-speed USB flash drives with full-speed standard.
- USB flash drives must support the File Allocation Table (FAT) system.

### File types

Documents:

- .doc or .docx
- .xls or .xlsx
- .ppt or .pptx
- .pdf
- .xps

Images:

- .dcx
- .gif
- .jpeg or .jpg
- .bmp



- .pcx
- .tiff or .tif
- .png

## Configuring confidential jobs

- 1 From the home screen, touch **Settings > Security > Confidential Print Setup**.
- 2 Configure the settings.

Use	To
Max Invalid PIN	Limit the number of times an invalid PIN can be entered. <b>Note:</b> When the limit is reached, the print jobs for that user name are deleted.
Confidential Job Expiration	Set the amount of time before confidential jobs are automatically deleted from the printer memory. <b>Note:</b> Confidential held jobs are stored in the printer until you log in and release or delete them manually.
Repeat Job Expiration	Set the amount of time before repeat jobs are deleted from the printer memory. <b>Note:</b> Repeat held jobs are stored so extra copies can be printed later.
Verify Job Expiration	Set the amount of time before verify jobs are deleted from the printer memory. <b>Note:</b> Verify jobs print one copy to check if it is satisfactory before printing the remaining copies.
Reserve Job Expiration	Set the amount of time before reserved jobs are deleted without being printed. <b>Note:</b> Reserve held jobs are automatically deleted after printing.

## Printing held jobs

- 1 With a document open, select **File > Print**.
- 2 Select the printer, and then do the following:
  - For Windows users, click **Properties** or **Preferences**, and then click **Print and Hold**.
  - For Macintosh users, select **Print and Hold**.
- 3 Select the print job type.
- 4 If necessary, assign a user name.
- 5 Send the print job.
- 6 From the printer home screen, touch **Held Jobs**.
- 7 Send the print job.

## Printing a font sample list

- 1 From the home screen, touch **Settings > Reports > Print > Print Fonts**.
- 2 Touch **PCL Fonts** or **PostScript Fonts**.

## Printing a directory list

From the home screen, touch **Settings > Reports > Print > Print Directory**.

## Canceling a print job

### From the printer control panel

- 1 From the home screen, touch **Job Queue**.

**Note:** You can also access this setting by touching the top section of the home screen.

- 2 Select the job to cancel.

### From the computer

- 1 Depending on the operating system, do either of the following:
  - Open the printers folder, and then select your printer.
  - From the System Preferences in the Apple menu, navigate to your printer.
- 2 Select the job to cancel.

# Securing the printer

## Erasing printer memory

To erase volatile memory or buffered data in your printer, turn off the printer.

To erase non-volatile memory or individual settings, device and network settings, security settings, and embedded solutions, do the following:

- 1 From the home screen, touch **Settings > Device > Maintenance > Out of Service Erase**.
- 2 Select the **Sanitize all information on nonvolatile memory** check box, and then touch **ERASE**.
- 3 Follow the instructions on the display.

## Erasing printer hard disk memory

- 1 From the home screen, touch **Settings > Device > Maintenance > Out of Service Erase**.
- 2 Select the **Sanitize all information on hard disk** check box, and then touch **ERASE**.
- 3 Follow the instructions on the display.

**Note:** This process can take from several minutes to more than an hour, making the printer unavailable for other tasks.

## Configuring printer hard disk encryption

- 1 From the home screen, touch **Settings > Security > Disk Encryption > Start Encryption**.

**Note:** Enabling disk encryption erases the contents of the hard disk. If necessary, back up important data from the printer before starting the encryption.

- 2 Follow the instructions on the display.

**Notes:**

- Do not turn off the printer during the encryption process. Loss of data can occur.
- Disk encryption can take from several minutes to more than an hour, making the printer unavailable for other tasks.
- After encryption, the printer returns to the home screen.

## Restoring factory default settings

From the home screen, touch **Settings > Device > Restore Factory Defaults > Restore Settings > Restore all settings > RESTORE > Start**.

For more information, see [“Erasing printer memory” on page 27](#).

## Statement of Volatility

Your printer contains various types of memory that can store device and network settings, and user data.

Type of memory	Description
Volatile memory	Your printer uses standard <i>random access memory</i> (RAM) to temporarily buffer user data during simple print jobs.
Non-volatile memory	Your printer may use two forms of non-volatile memory: EEPROM and NAND (flash memory). Both types are used to store the operating system, device settings, network information and bookmark settings, and embedded solutions.
Hard disk memory	Some printers have a hard disk drive installed. The printer hard disk is designed for printer-specific functionality. This lets the printer retain buffered user data from complex print jobs, as well as form data, and font data.

Erase the content of any installed printer memory in the following circumstances:

- The printer is being decommissioned.
- The printer hard disk is being replaced.
- The printer is being moved to a different department or location.
- The printer is being serviced by someone from outside your organization.
- The printer is being removed from your premises for service.
- The printer is being sold to another organization.

### Disposing of a printer hard disk

**Note:** Some printer models may not have a printer hard disk installed.

In high-security environments, it may be necessary to take additional steps to make sure that confidential data stored in the printer hard disk cannot be accessed when the printer—or its hard disk—is removed from your premises.

- **Degaussing**—Flushes the hard disk with a magnetic field that erases stored data
- **Crushing**—Physically compresses the hard disk to break component parts and render them unreadable
- **Milling**—Physically shreds the hard disk into small metal bits

**Note:** Most data can be erased electronically, but the only way to guarantee that all data are completely erased is to physically destroy each hard disk where data is stored.

# Maintaining the printer

**Warning—Potential Damage:** Failure to maintain optimum printer performance, or to replace parts and supplies, may cause damage to your printer.

## Networking

### Connecting the printer to a wireless network using Wi-Fi Protected Setup (WPS)

Before you begin, make sure that:

- The access point (wireless router) is WPS-certified or WPS-compatible. For more information, see the documentation that came with your access point.
- A wireless network adapter is installed in your printer. For more information, see the instructions that came with the adapter.

#### Using the Push Button method

- 1 From the control panel, navigate to:  
**Settings > Network/Ports > Wireless > Wi-Fi Protected Setup > Start Push Button Method**
- 2 Follow the instructions on the display.

#### Using the personal identification number (PIN) method

- 1 From the control panel, navigate to:  
**Settings > Network/Ports > Wireless > Wi-Fi Protected Setup > Start PIN Method**
- 2 Copy the eight-digit WPS PIN.
- 3 Open a Web browser, and then type the IP address of your access point in the address field.

**Notes:**

- View the printer IP address on the printer home screen. The IP address appears as four sets of numbers separated by periods, such as 123.123.123.123.
  - If you are using a proxy server, then temporarily disable it to load the Web page correctly.
- 4 Access the WPS settings. For more information, see the documentation that came with your access point.
  - 5 Enter the eight-digit PIN, and then save the changes.

## Changing port settings after installing an internal solutions port

### Notes:

- If the printer has a static IP address, then do not change the configuration.
- If the computers are configured to use the network name instead of an IP address, then do not change the configuration.
- If you are adding a wireless internal solutions port (ISP) to a printer previously configured for an Ethernet connection, then disconnect the printer from the Ethernet network.

### For Windows users

- 1 Open the printers folder.
- 2 From the shortcut menu of the printer with the new ISP, open the printer properties.
- 3 Configure the port from the list.
- 4 Update the IP address.
- 5 Apply the changes.

### For Macintosh users

- 1 From System Preferences in the Apple menu, navigate to the list of printers, and then select + > **IP**.
- 2 Type the IP address in the address field.
- 3 Apply the changes.

## Setting up serial printing (Windows only)

- 1 Set the parameters in the printer.
  - a From the control panel, navigate to the menu for the port settings.
  - b Locate the menu for the serial port settings, and then adjust the settings, if necessary.
  - c Apply the changes.
- 2 From your computer, open the printers folder, and then select your printer.
- 3 Open the printer properties, and then select the COM port from the list.
- 4 Set the COM port parameters in Device Manager.

### Notes:

- Serial printing reduces printing speed.
- Make sure that the serial cable is connected to the serial port on your printer.

## Cleaning the printer

 **CAUTION—SHOCK HAZARD:** To avoid the risk of electrical shock when cleaning the exterior of the printer, unplug the power cord from the electrical outlet and disconnect all cables from the printer before proceeding.

### Notes:

- Perform this task after every few months.
- Damage to the printer caused by improper handling is not covered by the printer warranty.

- 1 Turn off the printer, and then unplug the power cord from the electrical outlet.
- 2 Remove paper from the standard bin and multipurpose feeder.
- 3 Remove any dust, lint, and pieces of paper around the printer using a soft brush or vacuum.
- 4 Wipe the outside of the printer with a damp, soft, lint-free cloth.

### Notes:

- Do not use household cleaners or detergents, as they may damage the finish of the printer.
- Make sure that all areas of the printer are dry after cleaning.

- 5 Connect the power cord to the electrical outlet, and then turn on the printer.

 **CAUTION—POTENTIAL INJURY:** To avoid the risk of fire or electrical shock, connect the power cord to an appropriately rated and properly grounded electrical outlet that is near the product and easily accessible.

## Ordering supplies

To order supplies in the U.S., contact Lexmark at 1-800-539-6275 for information about Lexmark authorized supplies dealers in your area. In other countries or regions, go to [www.lexmark.com](http://www.lexmark.com) or contact the place where you purchased the printer.

**Note:** All life estimates for printer supplies assume printing on letter- or A4-size plain paper.

## Checking the status of parts and supplies

- 1 From the home screen, touch **Status/Supplies**.
- 2 Select the parts or supplies that you want to check.

**Note:** You can also access this setting by touching the top section of the home screen.

## Using genuine Lexmark parts and supplies

Your Lexmark printer is designed to function best with genuine Lexmark parts and supplies. Use of third-party supplies or parts may affect the performance, reliability, or life of the printer and its imaging components. It can also affect warranty coverage. Damage caused by the use of third-party parts and supplies is not covered by the warranty. All life indicators are designed to function with Lexmark parts and supplies, and may deliver unpredictable results if third-party parts and supplies are used. Imaging component usage beyond the intended life may damage your Lexmark printer or its associated components.

## Ordering toner cartridges

### Notes:

- The estimated cartridge yield is based on the ISO/IEC 19798 standard.
- Extremely low print coverage for extended periods of time may negatively affect actual yield and may cause cartridge parts to fail before exhaustion of toner.

### Return Program cartridges

Item	United States and Canada	European Economic Area (EEA+)	Rest of Asia Pacific (AP)	Latin America Distribution (LAD)	Rest of Europe, Middle East, and Africa (EMEA)	Australia and New Zealand (ANZ)
<b>Return Program toner cartridges</b>						
Black	74C10K0	74C20K0	74C30K0	74C40K0	74C50K0	74C60K0
Cyan	74C10C0	74C20C0	74C30C0	74C40C0	74C50C0	74C60C0
Magenta	74C10M0	74C20M0	74C30M0	74C40M0	74C50M0	74C60M0
Yellow	74C10Y0	74C20Y0	74C30Y0	74C40Y0	74C50Y0	74C60Y0
<b>High Yield Return Program toner cartridges</b>						
Black	74C1HK0	74C2HK0	74C3HK0	74C4HK0	74C5HK0	74C6HK0
Cyan	74C1HC0	74C2HC0	74C3HC0	74C4HC0	74C5HC0	74C6HC0
Magenta	74C1HM0	74C2HM0	74C3HM0	74C4HM0	74C5HM0	74C6HM0
Yellow	74C1HY0	74C2HY0	74C3HY0	74C4HY0	74C5HY0	74C6HY0

Item	Worldwide
<b>Regular toner cartridges</b>	
Cyan	74C0020
Magenta	74C0030
Yellow	74C0040
<b>High Yield regular toner cartridges</b>	
Black	74C0H10
Cyan	74C0H20
Magenta	74C0H30
Yellow	74C0H40

## Ordering imaging unit or imaging kit

Item	All countries and regions
<b>Return Program imaging unit or imaging kit</b>	
Black imaging unit	74C0ZK0



Item	All countries and regions
Color (CMY) imaging kit	74C0ZV0
<b>Regular imaging unit or imaging kit</b>	
Black imaging unit	74C0Z10
Color (CMY) imaging kit	74C0Z50

## Ordering a waste toner bottle

Item	Part number
Waste toner bottle	74C0W00

## Ordering a fuser maintenance kit

Fuser maintenance kit type	Part number
CS72x fuser maintenance kit, type 00, 110–120 V	41X0554
CS72x fuser maintenance kit, type 01, 220–240 V	41X0556
CS72x fuser maintenance kit, type 02, 100 V	41X0552

## Ordering a transfer module

Item	Part number
Transfer module	40X9929

# Replacing parts and supplies

## Replacing the imaging unit

1 Open door B.

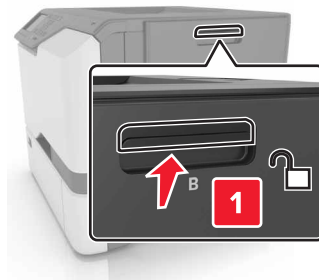

2 Remove the waste toner bottle.

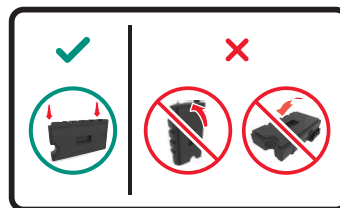
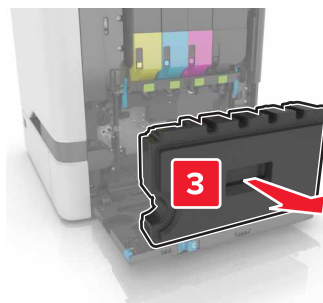
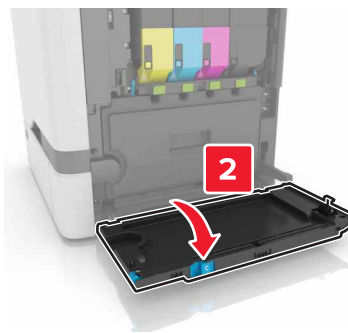
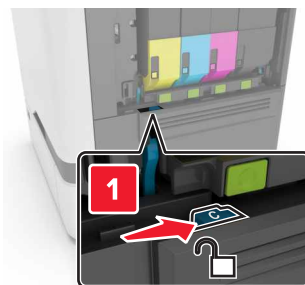

**3** Remove the imaging kit.

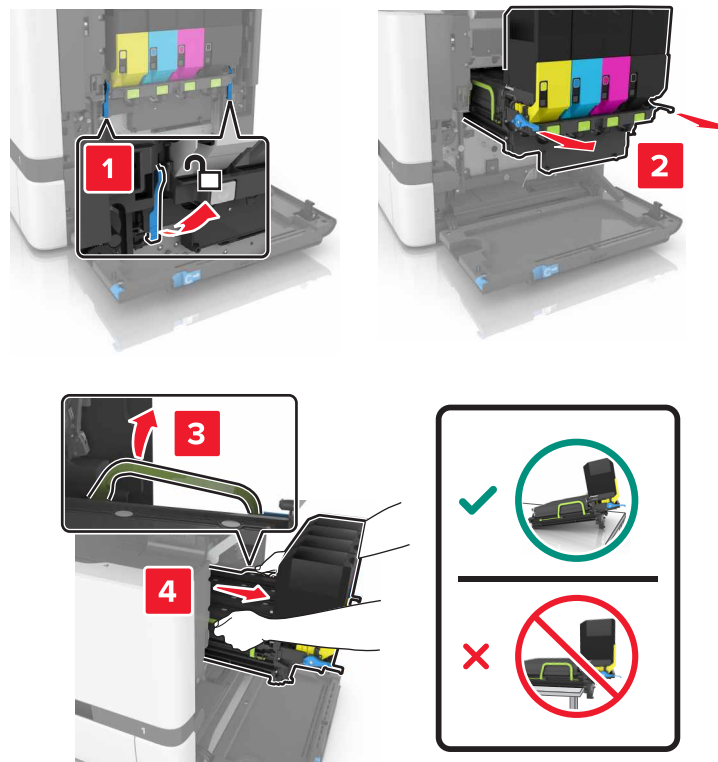

**4** Remove the black toner cartridge.

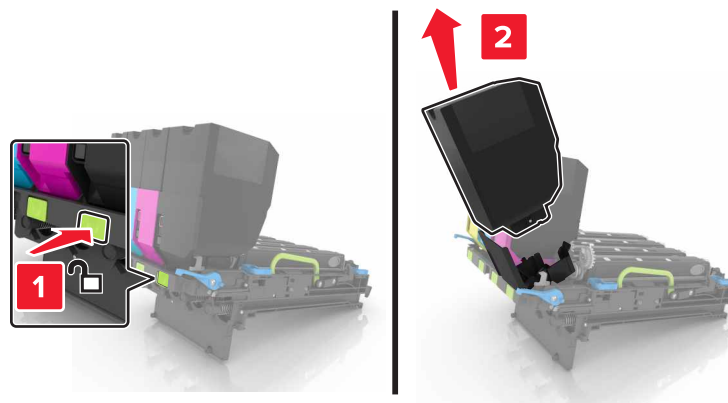

**5** Remove the imaging unit.

**Warning—Potential Damage:** Do not expose the photoconductor unit to direct light for more than 10 minutes. Extended exposure to light may cause print quality problems.

**Warning—Potential Damage:** Do not touch the shiny photoconductor drum under the imaging kit. Doing so may affect the quality of future print jobs.

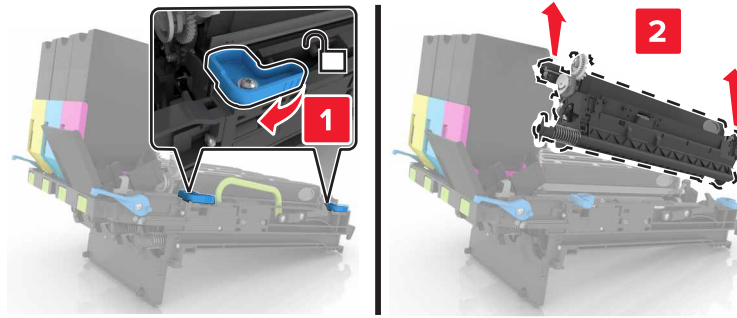

**6** Unpack the new imaging unit.

**7** Insert the new imaging unit.

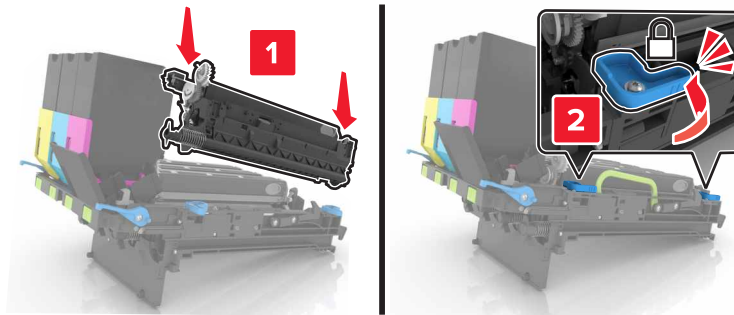

**8** Insert the black toner cartridge.

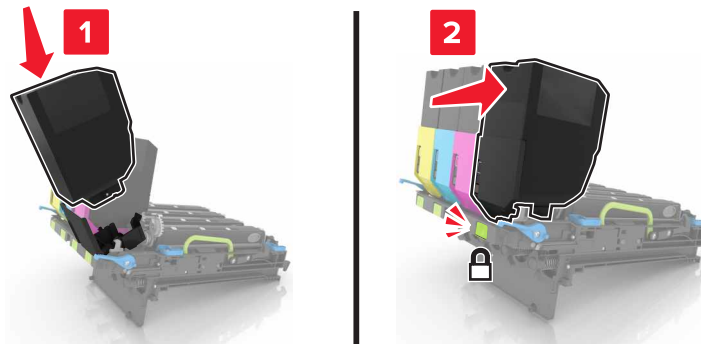

**9** Insert the imaging kit.

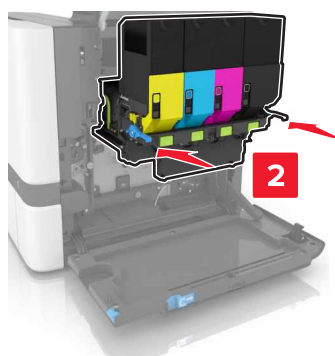
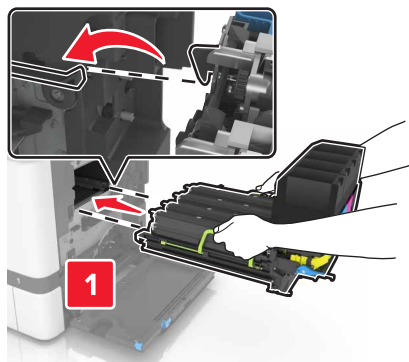

**10** Insert the waste toner bottle.

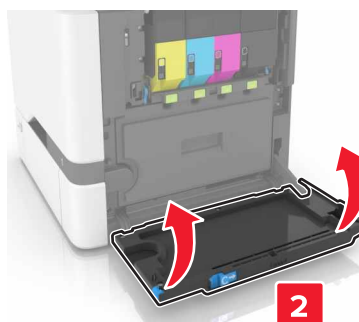
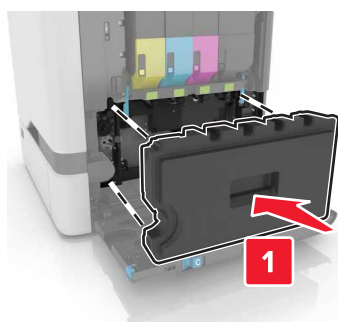

**11** Close door B.

## Replacing the imaging kit

1 Open door B.

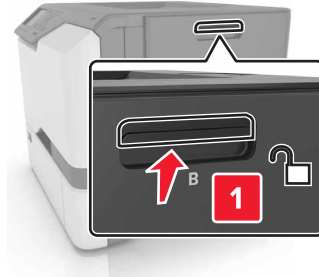

2 Remove the waste toner bottle.

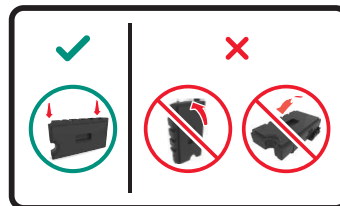
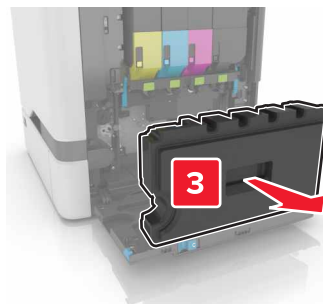
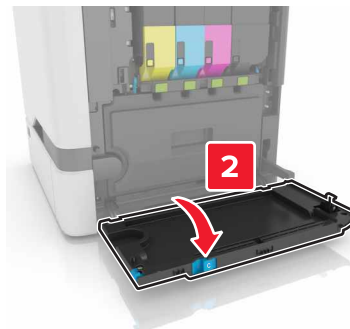
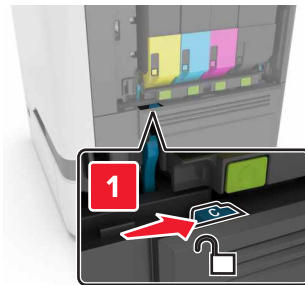

**3** Remove the imaging kit.

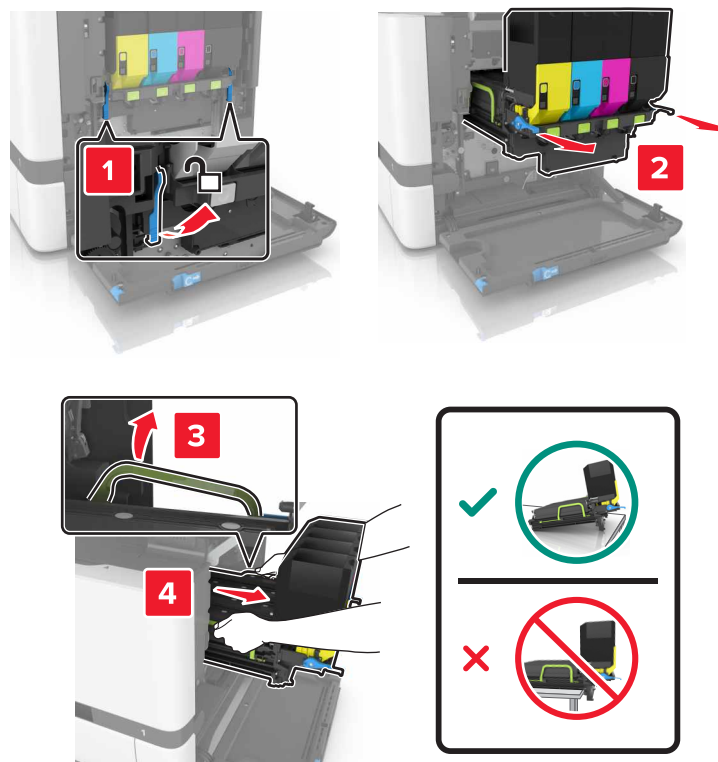

**4** Remove the toner cartridges.

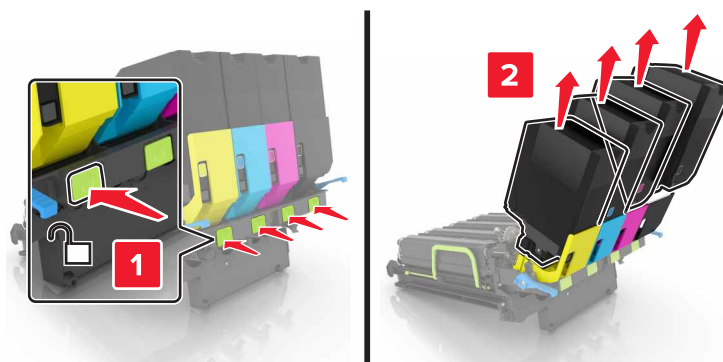

**5** Unpack the new imaging kit, and then remove the packing material.

**Note:** The imaging kit includes the imaging kit and the cyan, magenta, and yellow developer units.

**6** Remove the black imaging unit.

**Warning—Potential Damage:** Do not expose the photoconductor unit to direct light for more than 10 minutes. Extended exposure to light may cause print quality problems.

**Warning—Potential Damage:** Do not touch the shiny photoconductor drum under the imaging unit. Doing so may affect the quality of future print jobs.

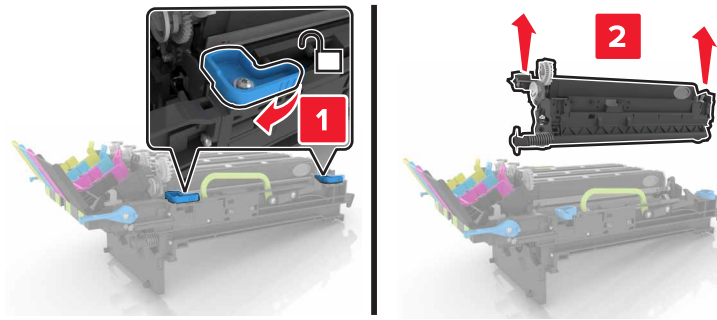

**Note:** The black imaging unit includes the black developer unit and photoconductor unit.

**7** Insert the black imaging unit into the new imaging kit.

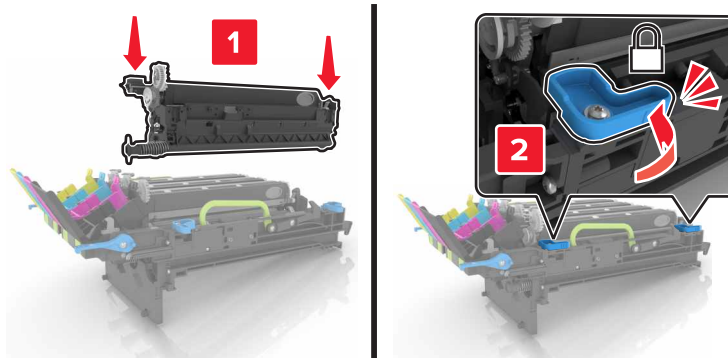

**8** Insert the toner cartridges.

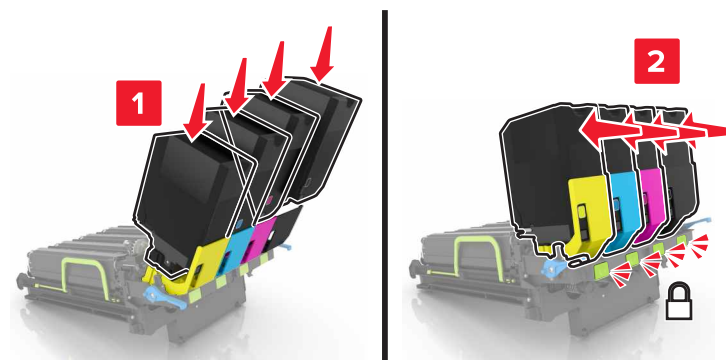



**9** Insert the new imaging kit.

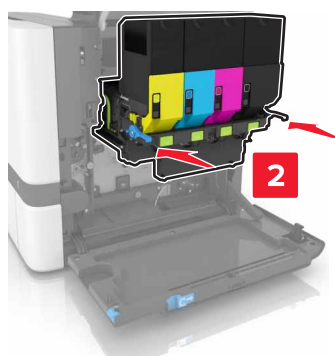
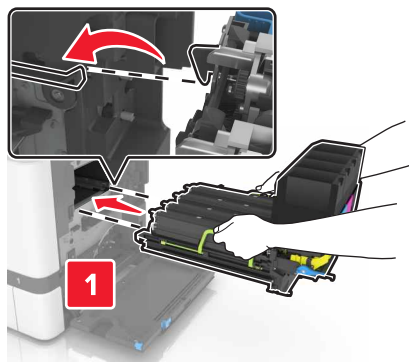

**10** Insert the waste toner bottle.

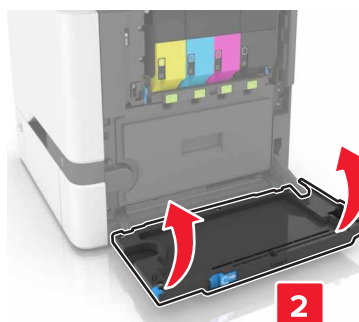
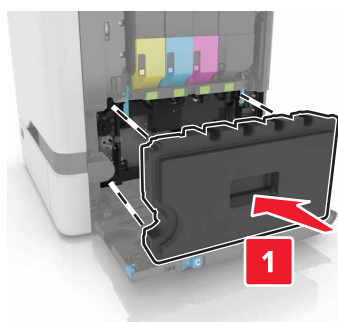

**11** Close door B.

## Replacing a toner cartridge

1 Open door B.

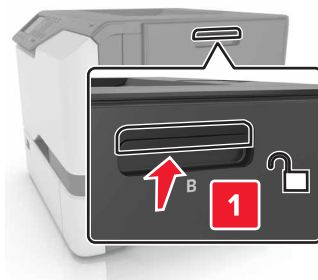

2 Remove the toner cartridge.

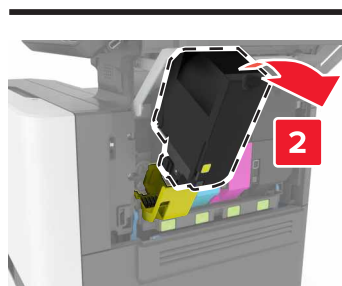
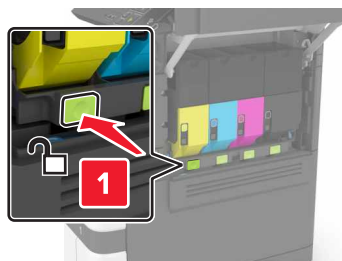

3 Unpack the new toner cartridge.

4 Insert the new toner cartridge.

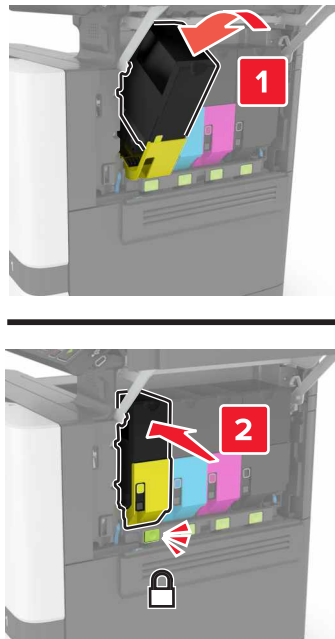

5 Close door B.

### Replacing the waste toner bottle

1 Open door B.

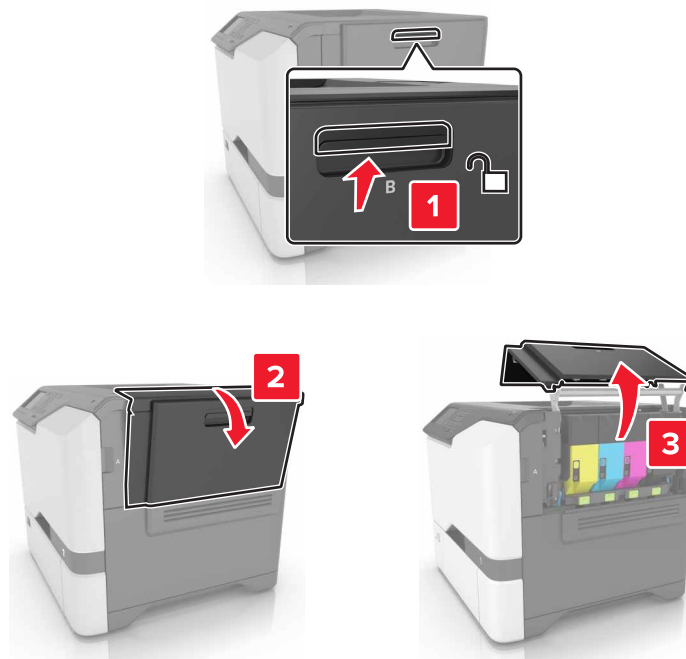

- 2 Remove the waste toner bottle.

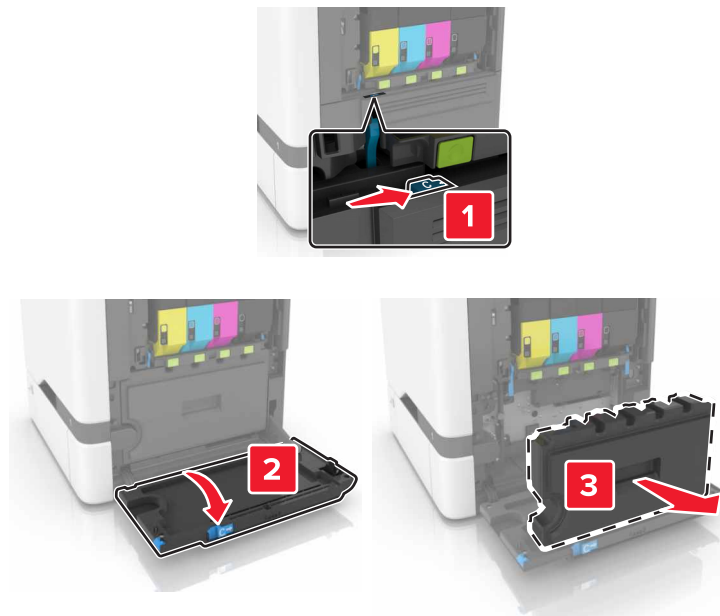

- 3 Unpack the new waste toner bottle.

- 4 Insert the new waste toner bottle.

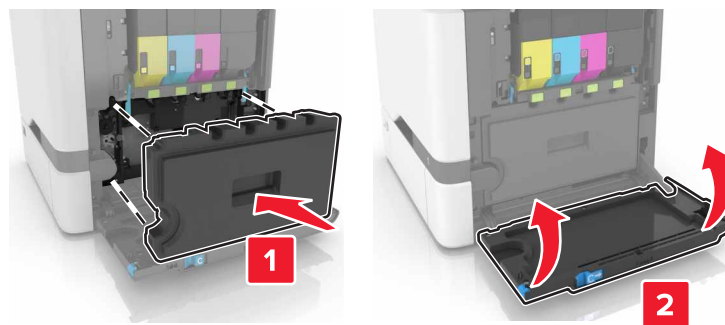

- 5 Close door B.

## Replacing the fuser

- 1 Turn off the printer, and then unplug the power cord from the electrical outlet.
- 2 Open doors A and D.

 **CAUTION—HOT SURFACE:** The inside of the printer might be hot. To reduce the risk of injury from a hot component, allow the surface to cool before touching it.

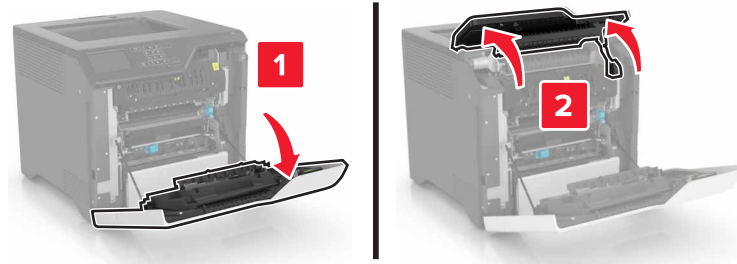

**3** Remove the fuser.

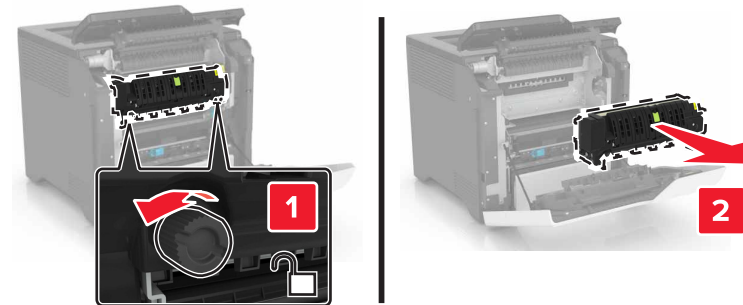

**4** Unpack the new fuser.

**5** Insert the new fuser.

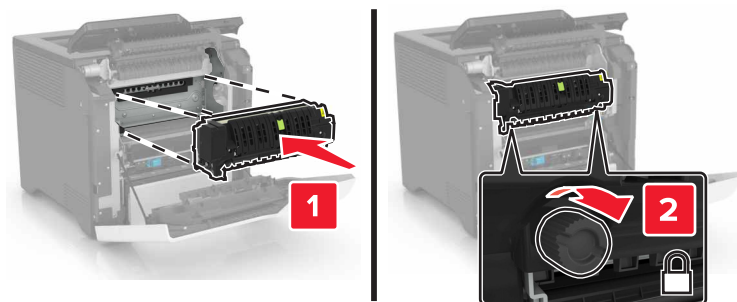

**6** Close doors D and A.

**7** Connect the power cord to the electrical outlet, and then turn on the printer.

**⚠ CAUTION—POTENTIAL INJURY:** To avoid the risk of fire or electrical shock, connect the power cord to an appropriately rated and properly grounded electrical outlet that is near the product and easily accessible.

**8** Reset the fuser maintenance counter.

For more information, see [“Resetting the maintenance counter” on page 54.](#)

## Replacing the pick roller

### Replacing the pick roller in the 550-sheet tray

- 1 Turn off the printer, and then unplug the power cord from the electrical outlet.
- 2 Remove the tray.

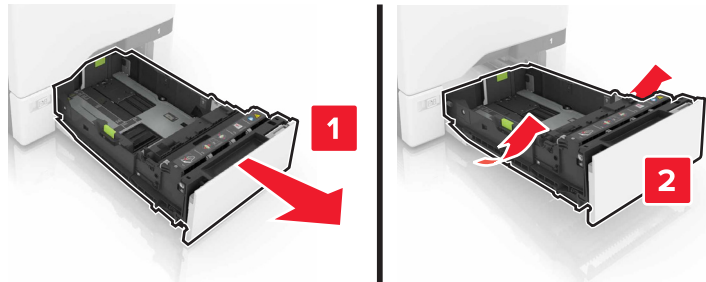

- 3 Remove the pick roller.



- 4 Unpack the new pick roller.

- 5 Insert the new pick roller until it *clicks* into place.

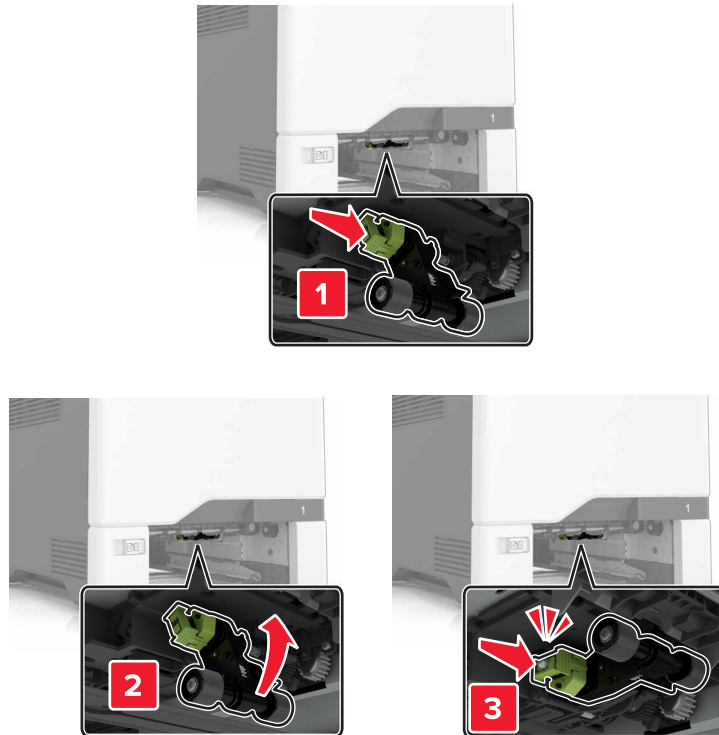

- 6 Insert the tray.
- 7 Connect the power cord to the electrical outlet, and then turn on the printer.

**⚠ CAUTION—POTENTIAL INJURY:** To avoid the risk of fire or electrical shock, connect the power cord to an appropriately rated and properly grounded electrical outlet that is near the product and easily accessible.

### Replacing the pick roller in the multipurpose feeder

- 1 Turn off the printer, and then unplug the power cord from the electrical outlet.
- 2 Open the multipurpose feeder.

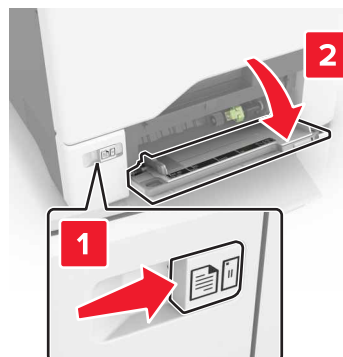

- 3 Remove the pick roller.



- 4 Unpack the new pick roller.

- 5 Insert the new pick roller until it *clicks* into place.



- 6 Close the multipurpose feeder.

- 7 Connect the power cord to the electrical outlet, and then turn on the printer.

**⚠ CAUTION—POTENTIAL INJURY:** To avoid the risk of fire or electrical shock, connect the power cord to an appropriately rated and properly grounded electrical outlet that is near the product and easily accessible.

## Replacing the separator bracket

- 1 Pull out the tray.

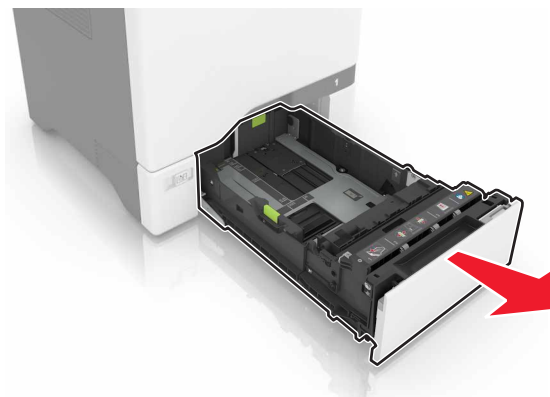



**2** Remove the separator bracket.

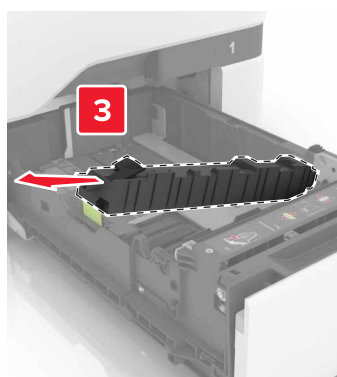
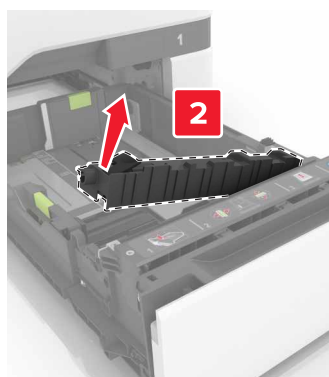

**3** Unpack the new separator bracket.

**4** Insert the new separator bracket until it *clicks* into place.

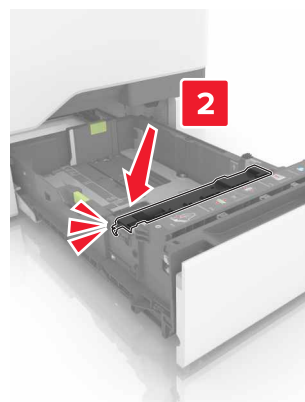
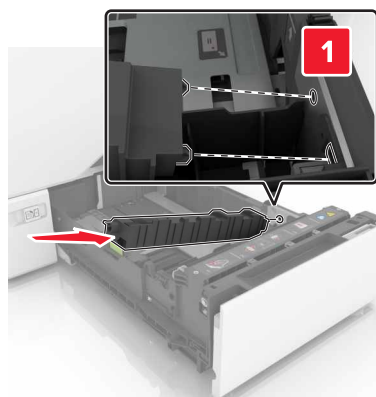

**5** Insert the tray.

## Replacing the transfer module

- 1 Turn off the printer, and then unplug the power cord from the electrical outlet.
- 2 Open door B.

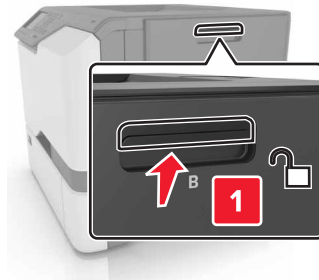

- 3 Remove the waste toner bottle.

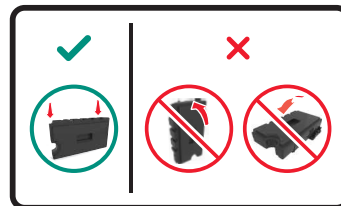
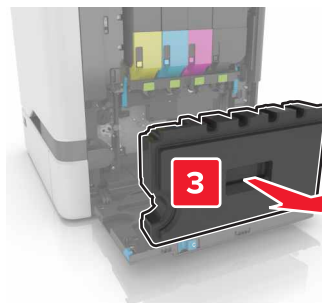
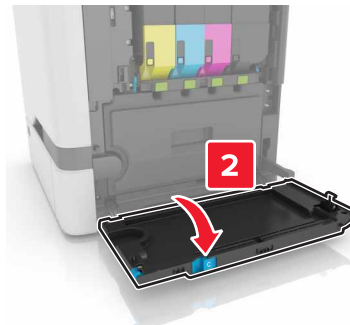
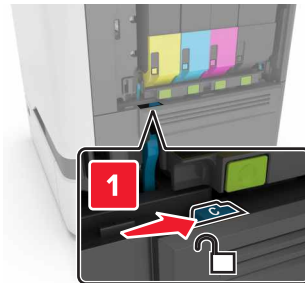

4 Remove the imaging kit.

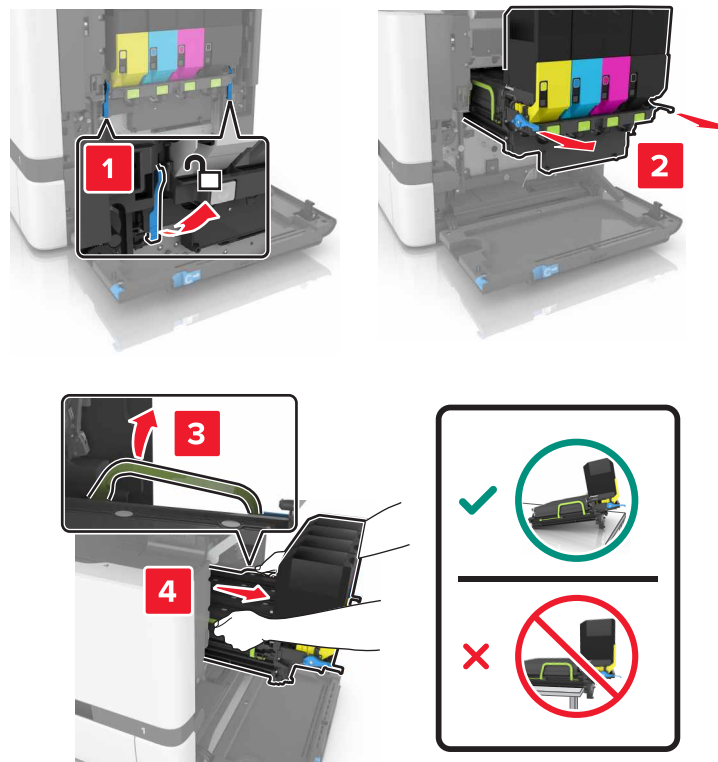

5 Open door A.

 **CAUTION—HOT SURFACE:** The inside of the printer might be hot. To reduce the risk of injury from a hot component, allow the surface to cool before touching it.

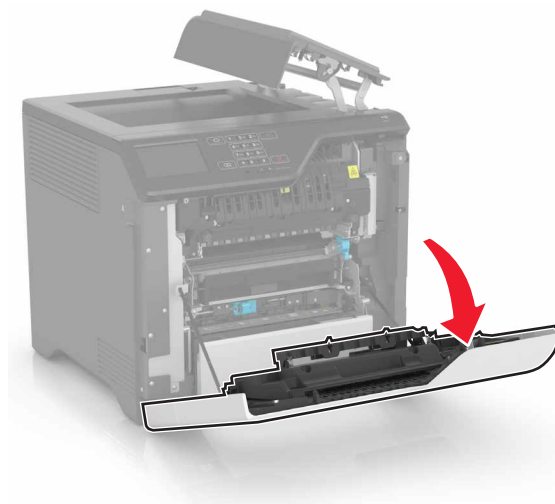

**6** Remove the transfer module.

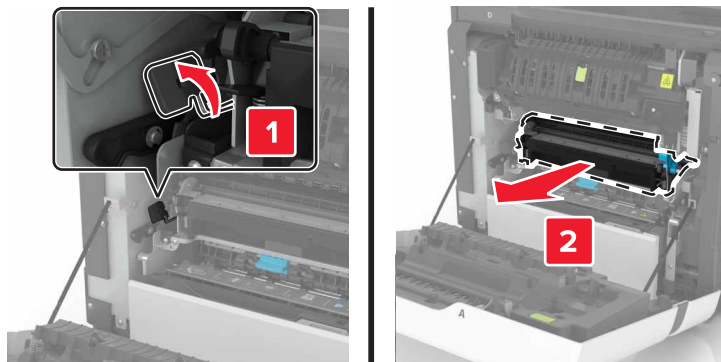

**7** Unpack the new transfer module, and then remove the packing material.

**8** Insert the new transfer module.

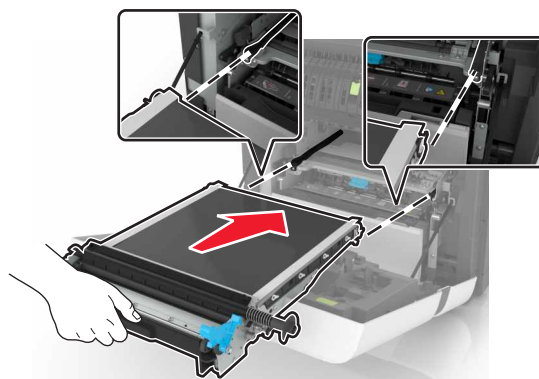

**9** Close door A.

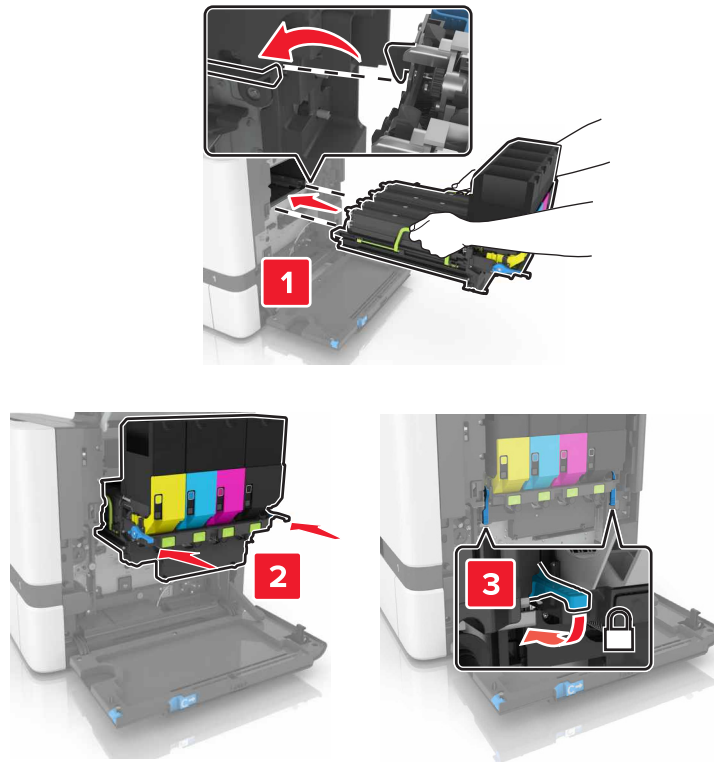
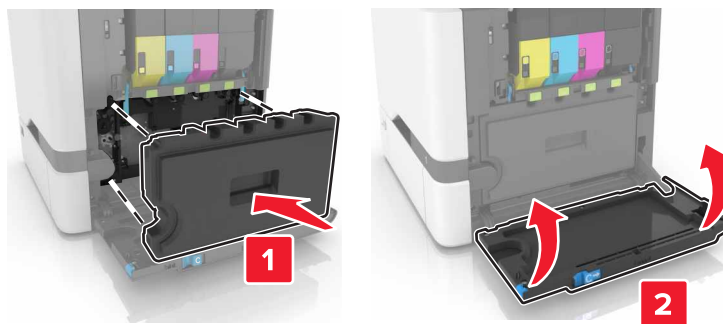
**10** Insert the imaging kit.**11** Insert the waste toner bottle.**12** Close door B.**13** Connect the power cord to the electrical outlet, and then turn on the printer.

**⚠ CAUTION—POTENTIAL INJURY:** To avoid the risk of fire or electrical shock, connect the power cord to an appropriately rated and properly grounded electrical outlet that is near the product and easily accessible.



**14** Reset the maintenance counter. For more information, see [“Resetting the maintenance counter” on page 54.](#)

## Resetting the maintenance counter

- 1 From the home screen, touch **Settings > Device > Maintenance > Configuration Menu > Supply Usage And Counters**.
- 2 Select **Fuser Reset** or **ITM Reset**.

## Moving the printer

### Moving the printer to another location

-  **CAUTION—POTENTIAL INJURY:** The printer weight is greater than 18 kg (40 lb) and requires two or more trained personnel to lift it safely.
-  **CAUTION—POTENTIAL INJURY:** To avoid the risk of fire or electrical shock, use only the power cord provided with this product or the manufacturer's authorized replacement.
-  **CAUTION—POTENTIAL INJURY:** When moving the printer, follow these guidelines to avoid personal injury or printer damage:
  - Make sure that all doors and trays are closed.
  - Turn off the printer, and then unplug the power cord from the electrical outlet.
  - Disconnect all cords and cables from the printer.
  - If the printer has a caster base, then carefully roll it to the new location. Use caution when passing over thresholds and breaks in flooring.
  - If the printer does not have a caster base but is configured with optional trays, then lift the printer off the trays. Do not try to lift the printer and the trays at the same time.
  - Always use the handholds on the printer to lift it.
  - Any cart used to move the printer must have a surface able to support the full footprint of the printer.
  - Any cart used to move the hardware options must have a surface able to support the dimensions of the options.
  - Keep the printer in an upright position.
  - Avoid severe jarring movements.
  - Make sure that your fingers are not under the printer when you set it down.
  - Make sure that there is adequate clearance around the printer.

**Note:** Damage to the printer caused by improper moving is not covered by the printer warranty.

### Shipping the printer

For shipping instructions, go to <http://support.lexmark.com> or contact customer support.

## Saving energy and paper

### Setting up power saver modes

#### Eco-Mode

- 1 From the home screen, touch **Settings > Device > Power Management > Eco-Mode**.
- 2 Select a setting.

#### Sleep mode

- 1 From the home screen, touch **Settings > Device > Power Management > Timeouts > Sleep Mode**.
- 2 Enter the number of minutes the printer stays idle before it enters Sleep mode.

#### Hibernate mode

- 1 From the home screen, touch **Settings > Device > Power Management > Timeouts > Hibernate Timeout**.
- 2 Select the amount of time before the printer enters hibernate mode.

#### Notes:

- Make sure to wake the printer from hibernate mode before sending a print job.
- The Embedded Web Server is disabled when the printer is in hibernate mode.

### Adjusting the brightness of printer display

- 1 From the homes screen, touch **Settings > Preferences > Screen Brightness**.
- 2 Adjust the setting.

### Conserving supplies

- Print on both sides of the paper.  
**Note:** Two-sided printing is the default setting in the print driver.
- Print multiple pages on a single sheet of paper.
- Use the preview feature to see how the document looks like before printing it.
- Print one copy of the document to check its content and format for accuracy.

## Recycling

### Recycling Lexmark products

To return Lexmark products for recycling:

- 1 Go to [www.lexmark.com/recycle](http://www.lexmark.com/recycle).
- 2 Select the product you want to recycle.

**Note:** Printer supplies and hardware not listed in the Lexmark Collection and Recycling Program may be recycled through your local recycling center.

## Recycling Lexmark packaging

Lexmark continually strives to minimize packaging. Less packaging helps to ensure that Lexmark printers are transported in the most efficient and environmentally sensitive manner and that there is less packaging to dispose of. These efficiencies result in fewer greenhouse emissions, energy savings, and natural resource savings. Lexmark also offers recycling of packaging components in some countries or regions. For more information, go to [www.lexmark.com/recycle](http://www.lexmark.com/recycle), and then choose your country or region. Information on available packaging recycling programs is included with the information on product recycling.

Lexmark cartons are 100% recyclable where corrugated recycling facilities exist. Facilities may not exist in your area.

The foam used in Lexmark packaging is recyclable where foam recycling facilities exist. Facilities may not exist in your area.

When you return a cartridge to Lexmark, you can reuse the box that the cartridge came in. Lexmark recycles the box.

## Returning Lexmark cartridges for reuse or recycling

The Lexmark Cartridge Collection Program allows you to return used cartridges for free to Lexmark for reuse or recycling. One hundred percent of the empty cartridges returned to Lexmark are either reused or demanufactured for recycling. The boxes used to return the cartridges are also recycled.

To return Lexmark cartridges for reuse or recycling, follow the instructions that came with the cartridge and use the prepaid shipping label. You can also do the following:

- 1 Go to [www.lexmark.com/recycle](http://www.lexmark.com/recycle).
- 2 Select the product you want to recycle.



# Clearing jams

## Avoiding jams

### Load paper properly

- Make sure that the paper lies flat in the tray.

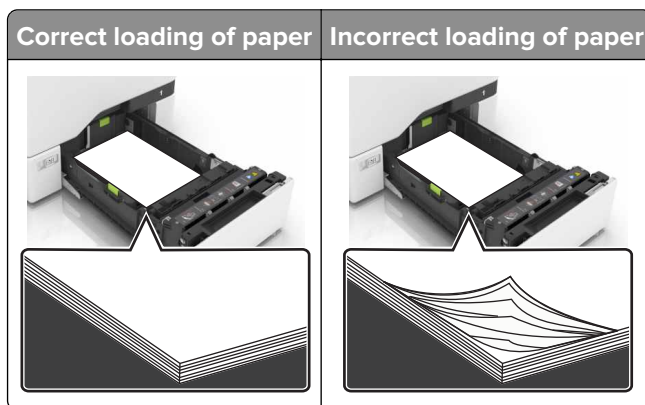

- Do not load or remove a tray while the printer is printing.
- Do not load too much paper. Make sure that the stack height is below the maximum paper fill indicator.
- Do not slide paper into the tray. Load paper as shown in the illustration.



- Make sure that the paper guides are positioned correctly and are not pressing tightly against the paper or envelopes.
- Push the tray firmly into the printer after loading paper.

### Use recommended paper

- Use only recommended paper or specialty media.
- Do not load paper that is wrinkled, creased, damp, bent, or curled.

- Flex, fan, and align the paper edges before loading.

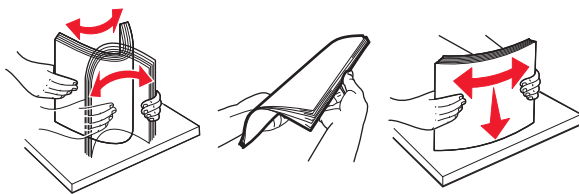

- Do not use paper that has been cut or trimmed by hand.
- Do not mix paper sizes, weights, or types in the same tray.
- Make sure that the paper size and type are set correctly on the computer or printer control panel.
- Store paper according to manufacturer recommendations.

## Identifying jam locations

### Notes:

- When Jam Assist is set to On, the printer flushes blank pages or pages with partial prints after a jammed page has been cleared. Check your printed output for blank pages.
- When Jam Recovery is set to On or Auto, the printer reprints jammed pages.

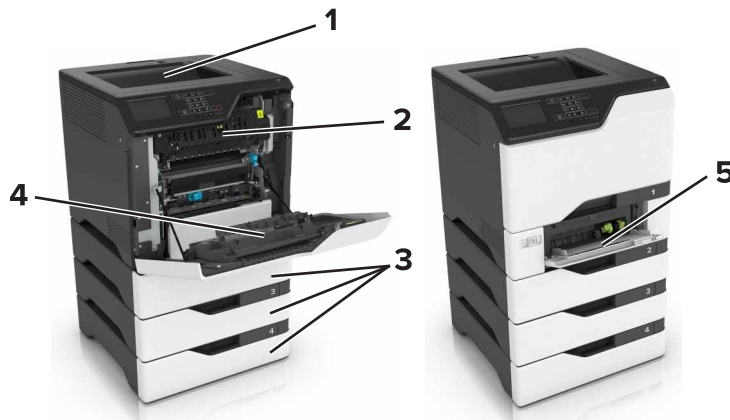

Jam locations	
1	Standard bin
2	Fuser
3	Trays
4	Duplex unit
5	Multipurpose feeder

## Paper jam in trays

- 1 Pull out the tray.



**Warning—Potential Damage:** A sensor inside the optional tray is easily damaged by static electricity. Touch a metal surface before removing the jammed paper in the tray.

- 2 Remove the jammed paper.

**Note:** Make sure that all paper fragments are removed.



- 3 Insert the tray.

## Paper jam in the multipurpose feeder

- 1 Remove paper from the multipurpose feeder.
- 2 Pull out the tray.
- 3 Remove the jammed paper.

**Note:** Make sure that all paper fragments are removed.

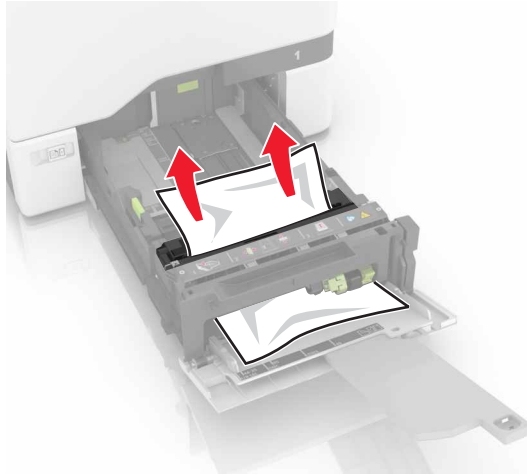

- 4 Insert the tray.

## Paper jam in the standard bin

- 1 Remove the jammed paper.

**Note:** Make sure that all paper fragments are removed.



- 2 Open doors A and D, and then remove any paper fragments.



**CAUTION—HOT SURFACE:** The inside of the printer might be hot. To reduce the risk of injury from a hot component, allow the surface to cool before touching it.

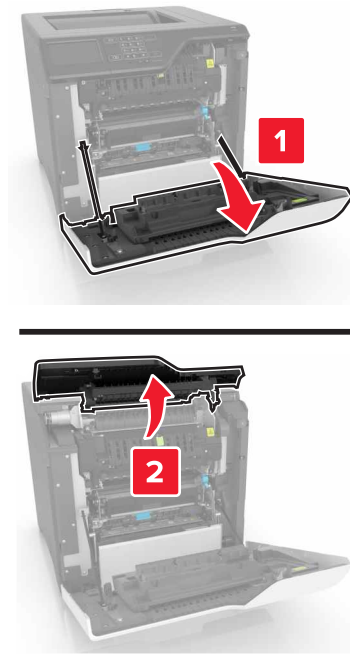

3 Close doors D and A.

## Paper jam in door A

### Paper jam in the fuser

1 Open door A.

 **CAUTION—HOT SURFACE:** The inside of the printer might be hot. To reduce the risk of injury from a hot component, allow the surface to cool before touching it.



2 Remove the jammed paper.

**Note:** Make sure that all paper fragments are removed.

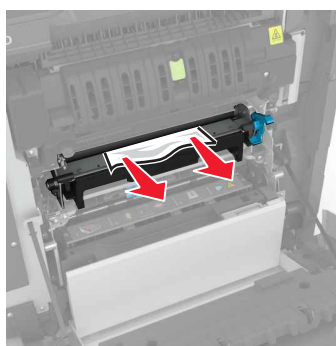
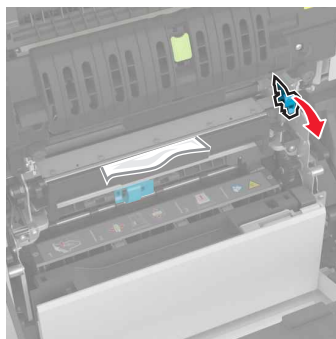

**3** Open the fuser access door.

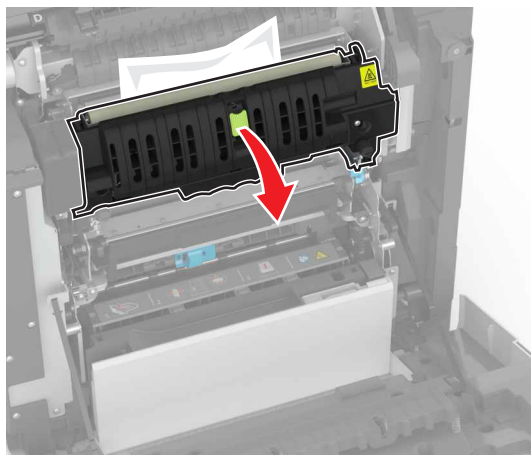

**4** Remove the jammed paper.

**Note:** Make sure that all paper fragments are removed.

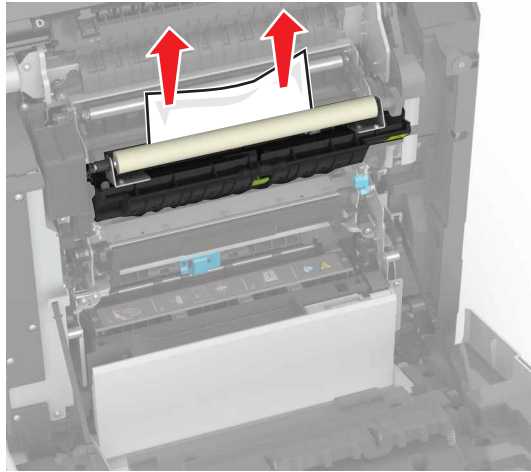

5 Close door A.

### Paper jam in the duplex unit

1 Open door A.

 **CAUTION—HOT SURFACE:** The inside of the printer might be hot. To reduce the risk of injury from a hot component, allow the surface to cool before touching it.



**2** Open the duplex cover.

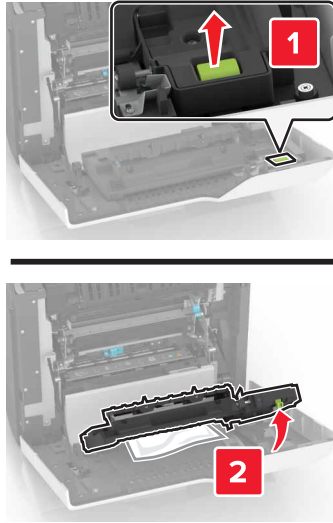

**3** Remove the jammed paper.

**Note:** Make sure that all paper fragments are removed.

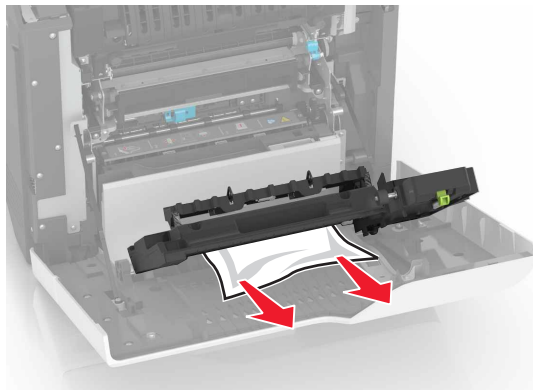

**4** Close the duplex cover and door A.



# Troubleshooting

## Network connection problems

### Embedded Web Server does not open

Action	Yes	No
<p><b>Step 1</b></p> <p>Check if you are using a supported browser:</p> <ul style="list-style-type: none"> <li>• Windows Internet Explorer version 9 or later</li> <li>• Macintosh Safari version 8.0.3 or later</li> <li>• Google Chrome</li> <li>• Mozilla Firefox</li> </ul> <p>Is your browser supported?</p>	Go to step 2.	Install a supported browser.
<p><b>Step 2</b></p> <p>Make sure that the printer IP address is correct.</p> <p>View the printer IP address:</p> <ul style="list-style-type: none"> <li>• From the home screen</li> <li>• From the TCP/IP section in the Network/Ports menu</li> <li>• By printing a network setup page or menu settings page, and then finding the TCP/IP section</li> </ul> <p><b>Note:</b> An IP address appears as four sets of numbers separated by periods, such as 123.123.123.123.</p> <p>Is the printer IP address correct?</p>	Go to step 3.	Type the correct printer IP address in the address field.  <b>Note:</b> Depending on the network settings, you may need to type “ <b>https://</b> ” instead of “ <b>http://</b> ” before the printer IP address to access the Embedded Web Server.
<p><b>Step 3</b></p> <p>Check if the printer is on.</p> <p>Is the printer on?</p>	Go to step 4.	Turn on the printer.
<p><b>Step 4</b></p> <p>Check if the network connection is working.</p> <p>Is the network connection working?</p>	Go to step 5.	Contact your administrator.
<p><b>Step 5</b></p> <p>Make sure that the cable connections to the printer and print server are secure.</p> <p>For more information, see the setup documentation that came with the printer.</p> <p>Are the cable connections secure?</p>	Go to step 6.	Tighten the cable connections.

Action	Yes	No
<p><b>Step 6</b> Temporarily disable the Web proxy servers.</p> <p><b>Note:</b> Proxy servers may block or restrict you from accessing certain Web sites including the Embedded Web Server.</p> <p>Are the Web proxy servers disabled?</p>	Go to step 7.	Contact your administrator.
<p><b>Step 7</b> Access the Embedded Web Server again by typing the correct IP address in the address field.</p> <p>Did the Embedded Web Server open?</p>	The problem is solved.	Contact <a href="#">customer support</a> .

### Unable to read flash drive

Action	Yes	No
<p><b>Step 1</b> Check if the flash drive is inserted into the front USB port.</p> <p><b>Note:</b> The flash drive does not work when it is inserted into the rear USB port.</p> <p>Is the flash drive inserted into the front USB port?</p>	Go to step 2.	The problem is solved.
<p><b>Step 2</b> Check if the flash drive is supported. For more information, see <a href="#">“Supported flash drives and file types” on page 24</a></p> <p>Does the error message still appear?</p>	Go to step 3.	The problem is solved.
<p><b>Step 3</b> Check if the front USB port is disabled. For more information, see <a href="#">“Enabling the USB port” on page 66</a>.</p> <p>Does the error message still appear?</p>	Contact <a href="#">customer support</a> .	The problem is solved.

### Enabling the USB port

From the home screen, touch **Settings > Network/Ports > USB > Enable USB Port**.

### Checking the printer connectivity

- 1 From the home screen, touch **Settings > Reports > Network > Network Setup Page**.
- 2 Check the first section of the network setup page, and confirm that the status is connected.  
If the status is not connected, then the LAN drop may be inactive, or the network cable may be unplugged or malfunctioning. Contact your administrator for assistance.

# Hardware options problems

## Cannot detect internal option

Action	Yes	No
<p><b>Step 1</b> Turn off the printer, wait for about 10 seconds, and then turn it back on.</p> <p>Does the internal option operate correctly?</p>	The problem is solved.	Go to step 2.
<p><b>Step 2</b> Print a menu settings page, and then check if the internal option appears in the Installed Features list.</p> <p>Is the internal option listed in the menu settings page?</p>	Go to step 4.	Go to step 3.
<p><b>Step 3</b> Check if the internal option is properly installed in the controller board.</p> <ul style="list-style-type: none"> <li><b>a</b> Turn off the printer, and then unplug the power cord from the electrical outlet.</li> <li><b>b</b> Make sure that the internal option is installed in the appropriate connector in the controller board.</li> <li><b>c</b> Connect the power cord to the electrical outlet, and then turn on the printer.</li> </ul> <p> <b>CAUTION—POTENTIAL INJURY:</b> To avoid the risk of fire or electrical shock, connect the power cord to an appropriately rated and properly grounded electrical outlet that is near the product and easily accessible.</p> <p>Does the internal option operate correctly?</p>	The problem is solved.	Go to step 4.
<p><b>Step 4</b> <b>a</b> Check if the internal option is available in the print driver. <b>Note:</b> If necessary, manually add the internal option in the print driver to make it available for print jobs. For more information, see <a href="#">“Adding available options in the print driver” on page 108.</a></p> <ul style="list-style-type: none"> <li><b>b</b> Resend the print job.</li> </ul> <p>Does the internal option operate correctly?</p>	The problem is solved.	Contact <a href="#">customer support</a> .

### Internal solutions port does not operate correctly

Action	Yes	No
<p><b>Step 1</b> Print a menu settings page, and then check if the internal solutions port (ISP) appears in the Installed Features list.</p> <p>Is the ISP listed in the Installed Features list?</p>	Go to step 3.	Go to step 2.
<p><b>Step 2</b> Remove, and then install the ISP. For more information, see <a href="#">“Installing an internal solutions port” on page 96</a>.</p> <p><b>Note:</b> Use a supported ISP.</p> <p>Does the ISP operate correctly?</p>	The problem is solved.	Go to step 3.
<p><b>Step 3</b> Check the cable and the ISP connection.</p> <ul style="list-style-type: none"> <li><b>a</b> Use the correct cable, and then make sure that it is securely connected to the ISP.</li> <li><b>b</b> Check if the ISP solution interface cable is securely connected into the receptacle of the controller board.</li> </ul> <p>Does the ISP operate correctly?</p>	The problem is solved.	Contact <a href="#">customer support</a> .

### Parallel or serial interface card does not operate correctly

Action	Yes	No
<p><b>Step 1</b> Print a menu settings page, and then check if the parallel or serial interface card appears in the Installed Features list.</p> <p>Is the parallel or serial interface card listed in the Installed Features list?</p>	Go to step 3.	Go to step 2.
<p><b>Step 2</b> Remove, and then install the parallel or serial interface card. For more information, see <a href="#">“Installing an internal solutions port” on page 96</a>.</p> <p>Does the parallel or serial interface card operate correctly?</p>	The problem is solved.	Go to step 3.
<p><b>Step 3</b> Check the connection between the cable and the parallel or serial interface card.</p> <p>Does the parallel or serial interface card operate correctly?</p>	The problem is solved.	Contact <a href="#">customer support</a> .

## Paper feed problems

### Envelope seals when printing

Action	Yes	No
<p><b>1</b> Use envelopes that have been stored in a dry environment.</p> <p><b>Note:</b> Printing on envelopes with high moisture content can seal the flaps.</p> <p><b>2</b> Resend the print job.</p> <p>Does the envelope seal when printing?</p>	<p>Contact <a href="#">customer support</a>.</p>	<p>The problem is solved.</p>

### Collated printing does not work

Action	Yes	No
<p><b>Step 1</b></p> <p><b>a</b> From the home screen, touch <b>Settings &gt; Print &gt; Layout &gt; Collate</b>.</p> <p><b>b</b> Set Collate to (1,2,3) (1,2,3).</p> <p><b>c</b> Resend the print job.</p> <p>Is the document printed and collated correctly?</p>	<p>The problem is solved.</p>	<p>Go to step 2.</p>
<p><b>Step 2</b></p> <p><b>a</b> From the printer software, set Collate to (1,2,3) (1,2,3).</p> <p><b>b</b> Resend the print job.</p> <p>Is the document printed and collated correctly?</p>	<p>The problem is solved.</p>	<p>Go to step 3.</p>
<p><b>Step 3</b></p> <p><b>a</b> Reduce the number of pages in the print job.</p> <p><b>b</b> Resend the print job.</p> <p>Is the document printed and collated correctly?</p>	<p>The problem is solved.</p>	<p>Contact <a href="#">customer support</a>.</p>

## Paper curl

Action	Yes	No
<p><b>Step 1</b> Move the paper guides in the tray to the correct position for the paper loaded.</p> <p>Is the paper still curled?</p>	Go to step 2.	The problem is solved.
<p><b>Step 2</b> <b>a</b> Depending on your operating system, specify the paper type and weight from the Printing Preferences or Print dialog.</p> <p><b>Notes:</b></p> <ul style="list-style-type: none"> <li>• Make sure that the settings match the paper loaded in the tray.</li> <li>• You can also change the settings on the printer control panel.</li> </ul> <p><b>b</b> Resend the print job.</p> <p>Is the paper still curled?</p>	Go to step 3.	The problem is solved.
<p><b>Step 3</b> <b>a</b> Remove paper from the tray, and then turn it over. <b>b</b> Resend the print job.</p> <p>Is the paper still curled?</p>	Go to step 4.	The problem is solved.
<p><b>Step 4</b> <b>a</b> Load paper from a fresh package. <b>Note:</b> Paper absorbs moisture due to high humidity. Store paper in its original wrapper until you are ready to use it. <b>b</b> Resend the print job.</p> <p>Is the paper still curled?</p>	Contact <a href="#">customer support</a> .	The problem is solved.

## Tray linking does not work

Action	Yes	No
<p><b>Step 1</b> <b>a</b> Check if the trays contain paper of the same size and type. <b>b</b> Check if the paper guides are positioned correctly. <b>c</b> Print the document.</p> <p>Do the trays link correctly?</p>	The problem is solved.	Go to step 2.

Action	Yes	No
<p><b>Step 2</b></p> <p><b>a</b> From the home screen, touch <b>Settings &gt; Paper &gt; Tray Configuration &gt; Paper Size/Type</b>.</p> <p><b>b</b> Set the paper size and type to match the paper loaded in the linked trays.</p> <p><b>c</b> Print the document.</p> <p>Do the trays link correctly?</p>	<p>The problem is solved.</p>	<p>Contact <a href="#">customer support</a>.</p>

## Paper frequently jams

Action	Yes	No
<p><b>Step 1</b></p> <p><b>a</b> Pull out the tray.</p> <p><b>b</b> Check if the paper is loaded correctly.</p> <p><b>Notes:</b></p> <ul style="list-style-type: none"> <li>• Make sure that the paper guides are positioned correctly.</li> <li>• Make sure that the stack height is below the maximum paper fill indicator.</li> <li>• Make sure to print on recommended paper size and type.</li> </ul> <p><b>c</b> Insert the tray.</p> <p><b>d</b> Print the document.</p> <p>Do paper jams still occur frequently?</p>	<p>Go to step 2.</p>	<p>The problem is solved.</p>
<p><b>Step 2</b></p> <p><b>a</b> From the Paper menu on the control panel, check if the printer is detecting the correct paper size.</p> <p><b>b</b> Resend the print job.</p> <p>Do paper jams still occur frequently?</p>	<p>Go to step 3.</p>	<p>The problem is solved.</p>
<p><b>Step 3</b></p> <p><b>a</b> Load paper from a fresh package.</p> <p><b>b</b> Print the document.</p> <p>Do paper jams still occur frequently?</p>	<p>Contact <a href="#">customer support</a>.</p>	<p>The problem is solved.</p>

## Jammed pages are not reprinted

Action	Yes	No
<p><b>1</b> From the home screen, touch <b>Settings &gt; Notifications &gt; Jam Content Recovery</b>.</p> <p><b>2</b> From the Jam Recovery menu, select <b>On</b> or <b>Auto</b>.</p> <p><b>3</b> Apply the changes.</p> <p>Are the jammed pages reprinted?</p>	The problem is solved.	Contact <a href="#">customer support</a> .

## Printing problems

### Confidential and other held documents do not print

Action	Yes	No
<p><b>Step 1</b></p> <p><b>a</b> From the control panel, check if the documents appear in the Held Jobs list.</p> <p><b>Note:</b> If the documents are not listed, then print the documents using the Print and Hold options.</p> <p><b>b</b> Print the documents.</p> <p>Are the documents printed?</p>	The problem is solved.	Go to step 2.
<p><b>Step 2</b></p> <p>The print job may contain a formatting error or invalid data.</p> <ul style="list-style-type: none"> <li>Delete the print job, and then send it again.</li> <li>For PDF files, generate a new file, and then print the documents.</li> </ul> <p>Are the documents printed?</p>	The problem is solved.	Go to step 3.
<p><b>Step 3</b></p> <p>If you are printing from the Internet, then the printer may be reading the multiple job titles as duplicates.</p> <p><b>For Windows users</b></p> <p><b>a</b> Open the Printing Preferences dialog.</p> <p><b>b</b> From the Print and Hold section, select <b>Keep duplicate documents</b>.</p> <p><b>c</b> Enter a PIN.</p> <p><b>d</b> Resend the print job.</p> <p><b>For Macintosh users</b></p> <p><b>a</b> Save and name each job differently.</p> <p><b>b</b> Send the job individually.</p> <p>Are the documents printed?</p>	The problem is solved.	Go to step 4.



Action	Yes	No
<p><b>Step 4</b></p> <p><b>a</b> Delete some held jobs to free up printer memory.</p> <p><b>b</b> Resend the print job.</p> <p>Are the documents printed?</p>	The problem is solved.	Go to step 5.
<p><b>Step 5</b></p> <p><b>a</b> Add printer memory.</p> <p><b>b</b> Resend the print job.</p> <p>Are the documents printed?</p>	The problem is solved.	Contact <a href="#">customer support</a> .

## Slow printing

Action	Yes	No
<p><b>Step 1</b></p> <p><b>a</b> Make sure that the printer is not in Eco-Mode and Quiet Mode.</p> <p><b>b</b> Resend the print job.</p> <p>Is the printer still printing slow?</p>	Go to step 2.	The problem is solved.
<p><b>Step 2</b></p> <p><b>a</b> Depending on your operating system, specify the paper type from the Printing Preferences or Print dialog.</p> <p><b>Notes:</b></p> <ul style="list-style-type: none"> <li>• Make sure that the setting matches the paper loaded in the tray.</li> <li>• You can also change the setting on the printer control panel.</li> </ul> <p><b>b</b> Resend the print job.</p> <p>Is the printer still printing slow?</p>	Go to step 3.	The problem is solved.
<p><b>Step 3</b></p> <p><b>a</b> Reduce the number of pages to print.</p> <p><b>b</b> Resend the print job.</p> <p>Is the printer still printing slow?</p>	Go to step 4.	The problem is solved.
<p><b>Step 4</b></p> <p><b>a</b> Remove held jobs.</p> <p><b>b</b> Resend the print job.</p> <p>Is the printer still printing slow?</p>	Go to step 5.	The problem is solved.

Action	Yes	No
<p><b>Step 5</b></p> <p><b>a</b> Connect the printer cable securely to the printer and the computer, print server, option, or other network device.</p> <p><b>b</b> Resend the print job.</p> <p>Is the printer still printing slow?</p>	Go to step 6.	The problem is solved.
<p><b>Step 6</b></p> <p><b>a</b> From the Quality menu on the control panel, set the Print Resolution to 4800CQ.</p> <p><b>b</b> Resend the print job.</p> <p>Is the printer still printing slow?</p>	Go to step 7.	The problem is solved.
<p><b>Step 7</b></p> <p><b>a</b> Make sure that the printer is not overheating.</p> <p><b>Notes:</b></p> <ul style="list-style-type: none"> <li>• Allow the printer to cool down after a very long print job.</li> <li>• Observe the recommended ambient temperature for the printer. For more information, see <a href="#">“Selecting a location for the printer” on page 9</a></li> </ul> <p><b>b</b> Resend the print job.</p> <p>Is the printer still printing slow?</p>	Go to step 8.	The problem is solved.
<p><b>Step 8</b></p> <p><b>a</b> Add more printer memory.</p> <p><b>b</b> Resend the print job.</p> <p>Is the printer still printing slow?</p>	Contact <a href="#">customer support</a> .	The problem is solved.

## Print jobs do not print

Action	Yes	No
<p><b>Step 1</b></p> <p><b>a</b> From the document you are trying to print, open the Print dialog, and then check if you have selected the correct printer.</p> <p><b>b</b> Resend the print job.</p> <p>Is the document printed?</p>	The problem is solved.	Go to step 2.
<p><b>Step 2</b></p> <p><b>a</b> Check if the printer is on.</p> <p><b>b</b> Resolve any error messages that appear on the display.</p> <p><b>c</b> Resend the print job.</p> <p>Is the document printed?</p>	The problem is solved.	Go to step 3.

Action	Yes	No
<p><b>Step 3</b></p> <p><b>a</b> Check if the ports are working and if the cables are securely connected to the computer and the printer. For more information, see the setup documentation that came with the printer.</p> <p><b>b</b> Resend the print job.</p> <p>Is the document printed?</p>	<p>The problem is solved.</p>	<p>Go to step 4.</p>
<p><b>Step 4</b></p> <p><b>a</b> Turn off the printer, wait for about 10 seconds, and then turn it back on.</p> <p><b>b</b> Resend the print job.</p> <p>Is the document printed?</p>	<p>The problem is solved.</p>	<p>Go to step 5.</p>
<p><b>Step 5</b></p> <p><b>a</b> Remove, and then reinstall the printer software. <b>Note:</b> The printer software is available at <a href="http://support.lexmark.com">http://support.lexmark.com</a>.</p> <p><b>b</b> Resend the print job.</p> <p>Is the document printed?</p>	<p>The problem is solved.</p>	<p>Contact <a href="#">customer support</a>.</p>

## Print quality is poor

### Blank or white pages

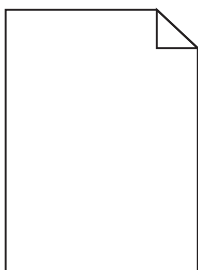

Action	Yes	No
<p><b>Step 1</b></p> <p><b>a</b> Remove, and then reinstall the imaging unit or imaging kit.</p> <p><b>Warning—Potential Damage:</b> Do not expose the imaging unit or imaging kit to direct light for more than 10 minutes. Extended exposure to light may cause print quality problems.</p> <p><b>Warning—Potential Damage:</b> To avoid damage, do not touch the underside of the imaging unit or imaging kit.</p> <p><b>b</b> Resend the print job.</p> <p>Is the printer still printing blank or white pages?</p>	Go to step 2.	The problem is solved.
<p><b>Step 2</b></p> <p>Replace the imaging unit or imaging kit, and then resend the print job.</p> <p>Is the printer still printing blank or white pages?</p>	Contact <a href="#">customer support</a> .	The problem is solved.

**Dark print**

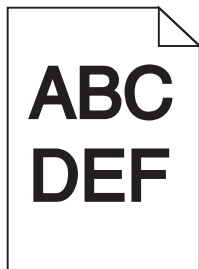

Action	Yes	No
<p><b>Step 1</b></p> <p><b>a</b> From the Quality menu on the control panel, select <b>Color Adjust</b>.</p> <p><b>b</b> Resend the print job.</p> <p>Is the print still too dark?</p>	Go to step 2.	The problem is solved.
<p><b>Step 2</b></p> <p><b>a</b> Depending on your operating system, reduce the toner darkness from the Printing Preferences or Print dialog.</p> <p><b>Note:</b> You can also change the settings on the printer control panel.</p> <p><b>b</b> Resend the print job.</p> <p>Is the print still too dark?</p>	Go to step 3.	The problem is solved.

Action	Yes	No
<p><b>Step 3</b></p> <p><b>a</b> Depending on your operating system, specify the paper type, texture, and weight from the Printing Preferences or Print dialog.</p> <p><b>Notes:</b></p> <ul style="list-style-type: none"> <li>• Make sure that the settings match the paper loaded in the tray.</li> <li>• You can also change the settings on the printer control panel.</li> </ul> <p><b>b</b> Resend the print job.</p> <p>Is the print still too dark?</p>	Go to step 4.	The problem is solved.
<p><b>Step 4</b></p> <p>Make sure that the paper has no texture or rough finishes.</p> <p>Are you printing on textured or rough paper?</p>	Change the texture settings to match the paper you are printing on.	Go to step 5.
<p><b>Step 5</b></p> <p><b>a</b> Load paper from a fresh package.</p> <p><b>Note:</b> Paper absorbs moisture due to high humidity. Store paper in its original wrapper until you are ready to use it.</p> <p><b>b</b> Resend the print job.</p> <p>Is the print still too dark?</p>	Go to step 6.	The problem is solved.
<p><b>Step 6</b></p> <p><b>a</b> Remove, and then reinstall the waste toner bottle.</p> <p><b>b</b> From the Quality menu on the control panel, select <b>Color Adjust</b>.</p> <p><b>c</b> Resend the print job.</p> <p>Is the print still too dark?</p>	Contact <a href="#">customer support</a> .	The problem is solved.

**Ghost images**

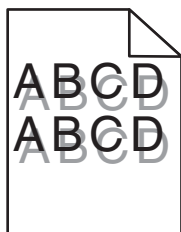

Action	Yes	No
<p><b>Step 1</b></p> <p><b>a</b> Load the tray with the correct paper type and weight.</p> <p><b>b</b> Resend the print job.</p> <p>Do ghost images still appear on prints?</p>	Go to step 2.	The problem is solved.
<p><b>Step 2</b></p> <p><b>a</b> Depending on your operating system, specify the paper type and weight from the Printing Preferences or Print dialog.</p> <p><b>Notes:</b></p> <ul style="list-style-type: none"> <li>• Make sure that the settings match the paper loaded in the tray.</li> <li>• You can also change the settings on the printer control panel.</li> </ul> <p><b>b</b> Resend the print job.</p> <p>Do ghost images still appear on prints?</p>	Go to step 3.	The problem is solved.
<p><b>Step 3</b></p> <p><b>a</b> From the Quality menu on the control panel, select <b>Color Adjust</b>.</p> <p><b>b</b> Resend the print job.</p> <p>Do ghost images still appear on prints?</p>	Contact <a href="#">customer support</a> .	The problem is solved.

**Gray background**

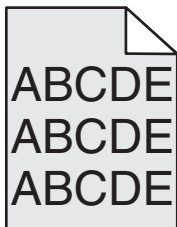

Action	Yes	No
<p><b>Step 1</b></p> <p><b>a</b> From the Quality menu on the control panel, select <b>Color Adjust</b>.</p> <p><b>b</b> Resend the print job.</p> <p>Does gray background still appear on prints?</p>	Go to step 2.	The problem is solved.

Action	Yes	No
<p><b>Step 2</b></p> <p><b>a</b> Remove, and then reinstall the imaging unit or imaging kit.</p> <p><b>Warning—Potential Damage:</b> Do not expose the imaging unit or imaging kit to direct light for more than 10 minutes. Extended exposure to light may cause print quality problems.</p> <p><b>Warning—Potential Damage:</b> To avoid damage, do not touch the underside of the imaging unit or imaging kit.</p> <p><b>b</b> Resend the print job.</p> <p>Does gray background still appear on prints?</p>	<p>Contact <a href="#">customer support</a>.</p>	<p>The problem is solved.</p>

**Horizontal dark lines**

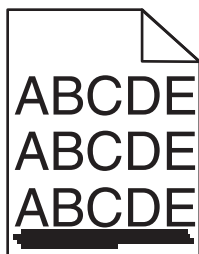

**Note:** If horizontal dark lines keep appearing on your prints, then see the “Repeating defects” topic.

Action	Yes	No
<p><b>Step 1</b></p> <p><b>a</b> Depending on your operating system, specify the tray or feeder from the Printing Preferences or Print dialog.</p> <p><b>b</b> Resend the print job.</p> <p>Do horizontal dark lines still appear on prints?</p>	<p>Go to step 2.</p>	<p>The problem is solved.</p>
<p><b>Step 2</b></p> <p><b>a</b> Depending on your operating system, specify the paper type and weight from the Printing Preferences or from Print dialog.</p> <p><b>Notes:</b></p> <ul style="list-style-type: none"> <li>• Make sure that the settings match the paper loaded in the tray.</li> <li>• You can also change the settings on the printer control panel.</li> </ul> <p><b>b</b> Resend the print job.</p> <p>Do horizontal dark lines still appear on prints?</p>	<p>Go to step 3.</p>	<p>The problem is solved.</p>

Action	Yes	No
<p><b>Step 3</b></p> <p><b>a</b> Load paper from a fresh package.</p> <p><b>Note:</b> Paper absorbs moisture due to high humidity. Store paper in its original wrapper until you use it.</p> <p><b>b</b> Resend the print job.</p> <p>Do horizontal dark lines still appear on prints?</p>	Go to step 4.	The problem is solved.
<p><b>Step 4</b></p> <p><b>a</b> Remove, and then reinstall the imaging unit or imaging kit.</p> <p><b>Warning—Potential Damage:</b> Do not expose the imaging unit or imaging kit to direct light for more than 10 minutes. Extended exposure to light may cause print quality problems.</p> <p><b>Warning—Potential Damage:</b> To avoid damage, do not touch the underside of the imaging unit or imaging kit.</p> <p><b>b</b> Resend the print job.</p> <p>Do horizontal dark lines still appear on prints?</p>	Contact <a href="#">customer support</a> .	The problem is solved.

### Horizontal white lines

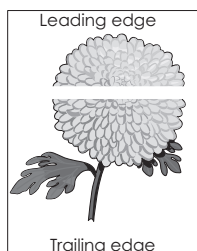

**Note:** If horizontal dark lines keep appearing on your prints, then see the “Repeating defects” topic.

Action	Yes	No
<p><b>Step 1</b></p> <p><b>a</b> Depending on your operating system, specify the paper type and weight from the Printing Preferences or Print dialog.</p> <p><b>Notes:</b></p> <ul style="list-style-type: none"> <li>• Make sure that the settings match the paper loaded in the tray.</li> <li>• You can also change the settings on the printer control panel.</li> </ul> <p><b>b</b> Resend the print job.</p> <p>Do horizontal white lines still appear on prints?</p>	Go to step 2.	The problem is solved.



Action	Yes	No
<p><b>Step 2</b></p> <p><b>a</b> Load the specified tray or feeder with the recommended paper type.</p> <p><b>b</b> Resend the print job.</p> <p>Do horizontal white lines still appear on prints?</p>	Go to step 3.	The problem is solved.
<p><b>Step 3</b></p> <p><b>a</b> Remove, and then reinstall the imaging unit or imaging kit.</p> <p><b>Warning—Potential Damage:</b> Do not expose the imaging unit or imaging kit to direct light for more than 10 minutes. Extended exposure to light can cause print quality problems.</p> <p><b>Warning—Potential Damage:</b> To avoid damage, do not touch the underside of the imaging unit or imaging kit.</p> <p><b>b</b> Resend the print job.</p> <p>Do horizontal white lines still appear on prints?</p>	Contact <a href="#">customer support</a> .	The problem is solved.

**Incorrect margins**

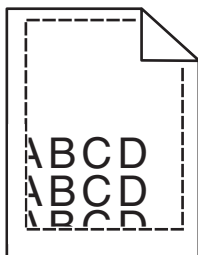

Action	Yes	No
<p><b>Step 1</b></p> <p><b>a</b> Squeeze and slide the paper guides to the correct position for the size of the paper you are loading.</p> <p><b>b</b> Resend the print job.</p> <p>Are the margins correct?</p>	The problem is solved.	Go to step 2.
<p><b>Step 2</b></p> <p><b>a</b> From the Paper menu on the control panel, check if the printer is detecting the correct paper size.</p> <p><b>b</b> Resend the print job.</p> <p>Are the margins correct?</p>	The problem is solved.	Go to step 3.

Action	Yes	No
<p><b>Step 3</b></p> <p><b>a</b> Depending on your operating system, specify the paper size from the Printing Preferences or Print dialog.</p> <p><b>Notes:</b></p> <ul style="list-style-type: none"> <li>• Make sure that the settings match the paper loaded in the tray.</li> <li>• You can also change the settings on the printer control panel.</li> </ul> <p><b>b</b> Resend the print job.</p> <p>Are the margins correct?</p>	<p>The problem is solved.</p>	<p>Contact <a href="#">customer support</a>.</p>

**Jagged or uneven characters**

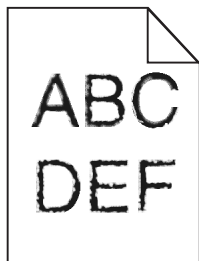

Action	Yes	No
<p><b>a</b> Check if the printer supports the fonts that are installed on your computer.</p> <ol style="list-style-type: none"> <li><b>1</b> From the control panel, touch: <b>Settings &gt; Reports &gt; Print &gt; Print Fonts</b></li> <li><b>2</b> Select <b>PCL Fonts</b> or <b>PS Fonts</b>.</li> </ol> <p><b>b</b> If the font is not supported, then install a supported font. For more information, contact your administrator.</p> <p><b>c</b> Resend the print job.</p> <p>Do prints still contain jagged or uneven characters?</p>	<p>Contact <a href="#">customer support</a>.</p>	<p>The problem is solved.</p>

**Light print**

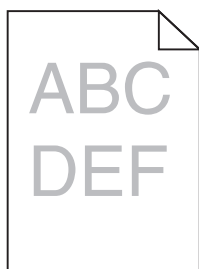

Action	Yes	No
<p><b>Step 1</b></p> <p><b>a</b> From the Quality menu on the control panel, select <b>Color Adjust</b>.</p> <p><b>b</b> Resend the print job.</p> <p>Is the print still too light?</p>	Go to step 2.	The problem is solved.
<p><b>Step 2</b></p> <p><b>a</b> Depending on your operating system, increase the toner darkness from the Printing Preferences or Print dialog.</p> <p><b>Note:</b> You can also change the settings on the printer control panel.</p> <p><b>b</b> Resend the print job.</p> <p>Is the print still too light?</p>	Go to step 3.	The problem is solved.
<p><b>Step 3</b></p> <p><b>a</b> Depending on your operating system, specify the paper type, texture, and weight from the Printing Preferences or Print dialog.</p> <p><b>Notes:</b></p> <ul style="list-style-type: none"> <li>• Make sure that the settings match the paper loaded in the tray.</li> <li>• You can also change the settings on the printer control panel.</li> </ul> <p><b>b</b> Resend the print job.</p> <p>Is the print still too light?</p>	Go to step 4.	The problem is solved.
<p><b>Step 4</b></p> <p>Make sure that the paper has no texture or rough finishes.</p> <p>Are you printing on textured or rough paper?</p>	Change the texture settings to match the paper you are printing on.	Go to step 5.
<p><b>Step 5</b></p> <p><b>a</b> Load paper from a fresh package.</p> <p><b>Note:</b> Paper absorbs moisture due to high humidity. Store paper in its original wrapper until you are ready to use it.</p> <p><b>b</b> Resend the print job.</p> <p>Is the print still too light?</p>	Go to step 6.	The problem is solved.
<p><b>Step 6</b></p> <p><b>a</b> Remove, and then reinstall the waste toner bottle.</p> <p><b>b</b> From the Quality menu on the control panel, select <b>Color Adjust</b>.</p> <p>Is the print still too light?</p>	Go to step 7.	The problem is solved.

Action	Yes	No
<p><b>Step 7</b> Remove, and then reinstall the imaging kit.</p> <p>Is the print still too light?</p>	Contact <a href="#">customer support</a> .	The problem is solved.

**Print crooked or skewed**

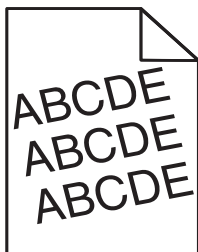

Action	Yes	No
<p><b>Step 1</b></p> <ul style="list-style-type: none"> <li>a Remove the tray.</li> <li>b Remove the paper, and then load paper from a fresh package.</li> </ul> <p><b>Note:</b> Paper absorbs moisture due to high humidity. Store paper in its original wrapper until you are ready to use it.</p> <ul style="list-style-type: none"> <li>c Squeeze and slide the paper guides to the correct position for the size of the paper you are loading.</li> <li>d Insert the tray.</li> <li>e Resend the print job.</li> </ul> <p>Is the print still crooked or skewed?</p>	Go to step 2.	The problem is solved.
<p><b>Step 2</b></p> <ul style="list-style-type: none"> <li>a Check if you are printing on a supported paper.</li> <li>b Resend the print job.</li> </ul> <p>Is the print still crooked or skewed?</p>	Contact <a href="#">customer support</a> .	The problem is solved.

**Repeating defects**

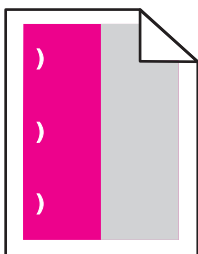

Action	Yes	No
<p><b>1</b> From the control panel, touch <b>Help &gt; Supplies Guide</b>.</p> <p><b>2</b> Measure the distance between the defects.</p> <ul style="list-style-type: none"> <li>• If the distance between the defects equals 43.90 mm (1.73 in.), or 45.50 mm (1.79 in.), then call customer support to replace the developer unit of the color where defects are seen.</li> <li>• If the distance between defects of a single color equals 94.20 mm (3.7 in.), 29.80 mm (1.17 in.), or 25.10 mm (0.99 in.), then replace the imaging unit or imaging kit.</li> <li>• If the distance between the defects equals 37.70 mm (1.48 in.), 78.50 mm (3.09 in.), or 55.0 mm (2.17 in.), then replace the transfer module.</li> <li>• If the distance between defects of all colors equals 95.0 mm (3.74 in.), 110 mm (4.33 in.), or 34.60 mm (1.36 in.), then replace the fuser.</li> </ul> <p>Do the repeating defects still appear?</p>	<p>Contact <a href="#">customer support</a> or your service representative.</p>	<p>The problem is solved.</p>

### Solid color or black images



Action	Yes	No
<p><b>a</b> Remove, and then reinstall the imaging unit or imaging kit.</p> <p><b>Warning—Potential Damage:</b> Do not expose the imaging unit or imaging kit to direct light for more than 10 minutes. Extended exposure to light may cause print quality problems.</p> <p><b>Warning—Potential Damage:</b> To avoid damage, do not touch the underside of the imaging unit or imaging kit.</p> <p><b>b</b> Resend the print job.</p> <p>Is the printer still printing solid color or black images?</p>	<p>Contact <a href="#">customer support</a>.</p>	<p>The problem is solved.</p>

### Text or images cut off

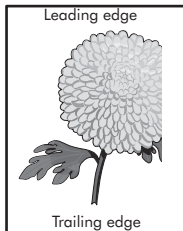
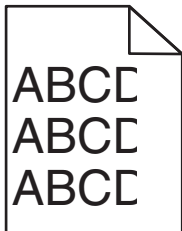

Action	Yes	No
<p><b>Step 1</b></p> <p><b>a</b> Move the paper guides in the tray to the correct position for the paper loaded.</p> <p><b>b</b> Resend the print job.</p> <p>Is the page or image still clipped?</p>	Go to step 2.	The problem is solved.
<p><b>Step 2</b></p> <p><b>a</b> Depending on your operating system, specify the paper size from the Printing Preferences or Print dialog.</p> <p><b>Notes:</b></p> <ul style="list-style-type: none"> <li>• Make sure that the settings match the paper loaded in the tray.</li> <li>• You can also change the settings on the printer control panel.</li> </ul> <p><b>b</b> Resend the print job.</p> <p>Is the page or image still clipped?</p>	Go to step 3.	The problem is solved.
<p><b>Step 3</b></p> <p><b>a</b> Remove, and then reinstall the imaging unit or imaging kit.</p> <p><b>Warning—Potential Damage:</b> Do not expose the imaging unit or imaging kit to direct light for more than 10 minutes. Extended exposure to light may cause print quality problems.</p> <p><b>Warning—Potential Damage:</b> To avoid damage, do not touch the underside of the imaging unit or imaging kit.</p> <p><b>b</b> Resend the print job.</p> <p>Is the page or image still clipped?</p>	Contact <a href="#">customer support</a> .	The problem is solved.

### Toner easily rubs off

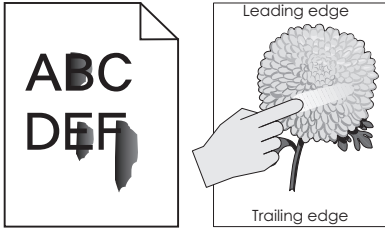

Action	Yes	No
<p><b>1</b> Depending on your operating system, specify the paper type, texture, and weight from the Printing Preferences or Print dialog.</p> <p><b>Notes:</b></p> <ul style="list-style-type: none"> <li>• Make sure that the settings match the paper loaded in the tray.</li> <li>• You can also change the settings on the printer control panel.</li> </ul> <p><b>2</b> Resend the print job.</p> <p>Does the toner still rub off?</p>	<p>Contact <a href="#">customer support</a>.</p>	<p>The problem is solved.</p>

### Uneven print density

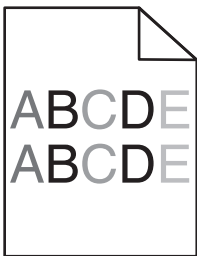

Action	Yes	No
<p>Replace the imaging unit or imaging kit, and then resend the print job.</p> <p><b>Warning—Potential Damage:</b> Do not expose the imaging unit or imaging kit to direct light for more than 10 minutes. Extended exposure to light can cause print quality problems.</p> <p><b>Warning—Potential Damage:</b> To avoid damage, do not touch the underside of the imaging unit or imaging kit.</p> <p>Is the print density uneven?</p>	<p>Contact <a href="#">customer support</a>.</p>	<p>The problem is solved.</p>

### Vertical dark lines or streaks

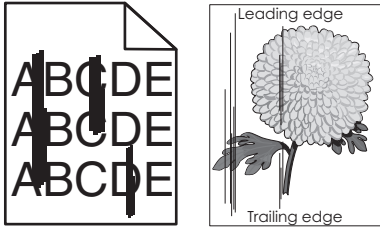

Action	Yes	No
<p><b>a</b> Remove, and then reinstall the imaging unit or imaging kit.</p> <p><b>Warning—Potential Damage:</b> Do not expose the imaging unit or imaging kit to direct light for more than 10 minutes. Extended exposure to light can cause print quality problems.</p> <p><b>Warning—Potential Damage:</b> To avoid damage, do not touch the underside of the imaging unit or imaging kit.</p> <p><b>b</b> Resend the print job.</p> <p>Do vertical dark lines or streaks still appear on prints?</p>	<p>Contact <a href="#">customer support</a>.</p>	<p>The problem is solved.</p>

### Vertical white lines

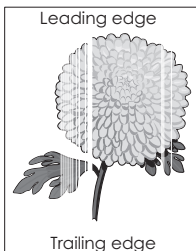

Action	Yes	No
<p><b>a</b> Remove, and then reinstall the imaging unit or imaging kit.</p> <p><b>Warning—Potential Damage:</b> Do not expose the imaging unit or imaging kit to direct light for more than 10 minutes. Extended exposure to light may cause print quality problems.</p> <p><b>Warning—Potential Damage:</b> To avoid damage, do not touch the underside of the imaging unit or imaging kit.</p> <p><b>b</b> Resend the print job.</p> <p>Do vertical white lines still appear on prints?</p>	<p>Contact <a href="#">customer support</a>.</p>	<p>The problem is solved.</p>



## The printer is not responding

Action	Yes	No
<p><b>Step 1</b> Connect the power cord to the electrical outlet.</p> <p> <b>CAUTION—POTENTIAL INJURY:</b> To avoid the risk of fire or electrical shock, connect the power cord to an appropriately rated and properly grounded electrical outlet that is near the product and easily accessible.</p> <p>Is the printer responding?</p>	The problem is solved.	Go to step 2.
<p><b>Step 2</b> Check if the electrical outlet is turned off by a switch or breaker.</p> <p>Is the electrical outlet turned off by a switch or breaker?</p>	Turn on the switch or reset the breaker.	Go to step 3.
<p><b>Step 3</b> Check if the printer is on.</p> <p>Is the printer on?</p>	Go to step 4.	Turn on the printer.
<p><b>Step 4</b> Check if the printer is in sleep or hibernate mode.</p> <p>Is the printer in sleep or hibernate mode?</p>	Press the power button to wake the printer.	Go to step 5.
<p><b>Step 5</b> Check if the cables connecting the printer and the computer are inserted in the correct ports.</p> <p>Are the cables inserted in the correct ports?</p>	Go to step 6.	<p>Make sure to match the following:</p> <ul style="list-style-type: none"> <li>• The USB cable with the USB port on the printer</li> <li>• The Ethernet cable with the Ethernet port on the printer</li> </ul>
<p><b>Step 6</b> Turn off the printer, reinstall the hardware options, and then turn it back on.</p> <p>For more information, see the documentation that came with the option.</p> <p>Is the printer responding?</p>	The problem is solved	Go to step 7.
<p><b>Step 7</b> Install the correct print driver.</p> <p>Is the printer responding?</p>	The problem is solved	Go to step 8.

Action	Yes	No
<p><b>Step 8</b> Turn off the printer, wait for about 10 seconds, and then turn it back on.</p> <p>Is the printer responding?</p>	The problem is solved.	Contact <a href="#">customer support</a> .

## Job prints from the wrong tray or on the wrong paper

Action	Yes	No
<p><b>Step 1</b>  <b>a</b> Check if you are printing on a supported paper.  <b>b</b> Print the document.</p> <p>Is the document printed from the correct tray or on the correct paper?</p>	The problem is solved.	Go to step 2.
<p><b>Step 2</b>  <b>a</b> Depending on your operating system, specify the paper size from the Printing Preferences or Print dialog.</p> <p><b>Notes:</b></p> <ul style="list-style-type: none"> <li>• Make sure that the settings match the paper loaded in the tray.</li> <li>• You can also change the settings on the printer control panel.</li> </ul> <p><b>b</b> Print the document.</p> <p>Is the document printed from the correct tray or on the correct paper?</p>	The problem is solved.	Go to step 3.
<p><b>Step 3</b>  <b>a</b> Check if the trays are not linked.                      For more information, see <a href="#">“Linking trays” on page 21</a>  <b>b</b> Print the document.</p> <p>Is the document printed from the correct tray or on the correct paper?</p>	The problem is solved.	Contact <a href="#">customer support</a> .

## Color quality problems

### Adjusting toner darkness

- 1 From the home screen, touch **Settings > Print > Quality**.
- 2 Adjust the toner darkness.

3 Apply the changes.

## Modifying the colors in printed output

- 1 From the home screen, touch **Settings > Print > Quality > Advanced Imaging > Color Correction > Manual**.
- 2 From the Advanced Imaging menu, select **Color Correction Content**.
- 3 Choose the appropriate color conversion setting.

Object type	Color conversion tables
RGB Image RGB Text RGB Graphics	<ul style="list-style-type: none"> <li>• <b>Vivid</b>—Produces brighter, more saturated colors and may be applied to all incoming color formats.</li> <li>• <b>sRGB Display</b>—Produces an output that approximates the colors displayed on a computer monitor. Black toner usage is optimized for printing photographs.</li> <li>• <b>Display-True Black</b>—Produces an output that approximates the colors displayed on a computer monitor. This setting uses only black toner to create all levels of neutral gray.</li> <li>• <b>sRGB Vivid</b>—Provides an increased color saturation for the sRGB Display color correction. Black toner usage is optimized for printing business graphics.</li> <li>• <b>Off</b></li> </ul>
CMYK Image CMYK Text CMYK Graphics	<ul style="list-style-type: none"> <li>• <b>US CMYK</b>—Applies color correction to approximate the Specifications for Web Offset Publishing (SWOP) color output.</li> <li>• <b>Euro CMYK</b>—Applies color correction to approximate Euroscale color output.</li> <li>• <b>Vivid CMYK</b>—Increases the color saturation of the US CMYK color correction setting.</li> <li>• <b>Off</b></li> </ul>

## FAQ about color printing

### What is RGB color?

RGB color is a method of describing colors by indicating the amount of red, green, or blue used to produce a certain color. Red, green, and blue light can be added in various amounts to produce a large range of colors observed in nature. Computer screens, scanners, and digital cameras use this method to display colors.

### What is CMYK color?

CMYK color is a method of describing colors by indicating the amount of cyan, magenta, yellow, and black used to reproduce a particular color. Cyan, magenta, yellow, and black inks or toners can be printed in various amounts to produce a large range of colors observed in nature. Printing presses, inkjet printers, and color laser printers create colors in this manner.

### How is color specified in a document to be printed?

Software programs are used to specify and modify the document color using RGB or CMYK color combinations. For more information, see the software program Help topics.

### How does the printer know what color to print?

When printing a document, information describing the type and color of each object is sent to the printer and is passed through color conversion tables. Color is translated into the appropriate amounts of cyan, magenta, yellow, and black toner used to produce the color you want. The object information determines the application of color conversion tables. For example, it is possible to apply one type of color conversion table to text while applying a different color conversion table to photographic images.

### What is manual color correction?

When manual color correction is enabled, the printer employs user-selected color conversion tables to process objects. Manual color correction settings are specific to the type of object being printed (text, graphics, or images). It is also specific to how the color of the object is specified in the software program (RGB or CMYK combinations). To apply a different color conversion table manually, see [“Modifying the colors in printed output” on page 91](#).

If the software program does not specify colors with RGB or CMYK combinations, then manual color correction is not useful. It is also not effective if the software program or the computer operating system controls the adjustment of colors. In most situations, setting the Color Correction to Auto generates preferred colors for the documents.

### How can I match a particular color (such as a corporate logo)?

From the printer Quality menu, nine types of Color Samples sets are available. These sets are also available from the Color Samples page of the Embedded Web Server. Selecting any sample set generates multiple-page prints consisting of hundreds of colored boxes. Each box contains a CMYK or RGB combination, depending on the table selected. The observed color of each box is obtained by passing the CMYK or RGB combination labeled on the box through the selected color conversion table.

By examining Color Samples sets, you can identify the box with color closest to the color being matched. The color combination labeled on the box can then be used for modifying the color of the object in a software program. For more information, see the software program Help topics. Manual color correction may be necessary to use the selected color conversion table for the particular object.

Selecting which Color Samples set to use for a particular color-matching problem depends on:

- The Color Correction setting being used (Auto, Off, or Manual)
- The type of object being printed (text, graphics, or images)
- How the color of the object is specified in the software program (RGB or CMYK combinations)

If the software program does not specify colors with RGB or CMYK combinations, then the Color Samples pages are not useful. Additionally, some software programs adjust the RGB or CMYK combinations specified in the program through color management. In these situations, the printed color may not be an exact match of the Color Samples pages.

## The print appears tinted

Action	No	Yes
Adjust the color balance. <b>a</b> From the home screen, touch <b>Settings &gt; Print &gt; Quality &gt; Advanced Imaging &gt; Color Balance</b> . <b>b</b> Adjust the setting. <b>c</b> Resend the print job.  Does the print still appear tinted?	The problem is solved.	Contact <a href="#">customer support</a> .

## Contacting customer support

When you contact customer support, you will need to be able to describe the problem you are experiencing, the message on the printer display, and the troubleshooting steps you have already taken to find a solution.

You need to know your printer model type and serial number. For more information, see the label at the back of the printer. The serial number is also listed on the menu settings page.

Lexmark has various ways to help you solve your printing problem. Visit the Lexmark Web site at <http://support.lexmark.com>, and then select one of the following:

<b>Tech Library</b>	You can browse our library of manuals, support documentation, drivers, and other downloads to help you solve common problems.
<b>E-mail</b>	You can send an e-mail to the Lexmark team, describing your problem. A service representative will respond and provide you with information to solve your problem.
<b>Live chat</b>	You can chat directly with a service representative. They can work with you to solve your printer problem or provide assistance through Assisted Service where the service representative can remotely connect to your computer through the Internet to troubleshoot problems, install updates, or complete other tasks to help you successfully use your Lexmark product.

Telephone support is also available. In the U.S. or Canada, call 1-800-539-6275. For other countries or regions, visit <http://support.lexmark.com>.

# Upgrading and migrating

## Hardware

### Available internal options

- Memory card
  - DDR3 DIMM
  - Flash memory
    - Fonts
  - Application cards
    - Forms and Bar Code
    - PRESCRIBE
    - IPDS
- Lexmark™ Internal Solutions Port (ISP)
  - MarkNet™ N8360 (802.11 b/g/n/a wireless print server bundled with LEX-M06-001 Mobile Solutions Module)
  - IEEE 1284-B Parallel Card
  - RS-232C Serial Card

### Installing a memory card



**CAUTION—SHOCK HAZARD:** To avoid the risk of electrical shock, if you are accessing the controller board or installing optional hardware or memory devices sometime after setting up the printer, then turn the printer off, and unplug the power cord from the electrical outlet before continuing. If you have any other devices attached to the printer, then turn them off as well, and unplug any cables going into the printer.

- 1 Turn off the printer, and then unplug the power cord from the electrical outlet.
- 2 Using a flat-head screwdriver, remove the controller board access cover.

**Warning—Potential Damage:** Controller board electronic components are easily damaged by static electricity. Touch a metal surface on the printer before touching any controller board components or connectors.

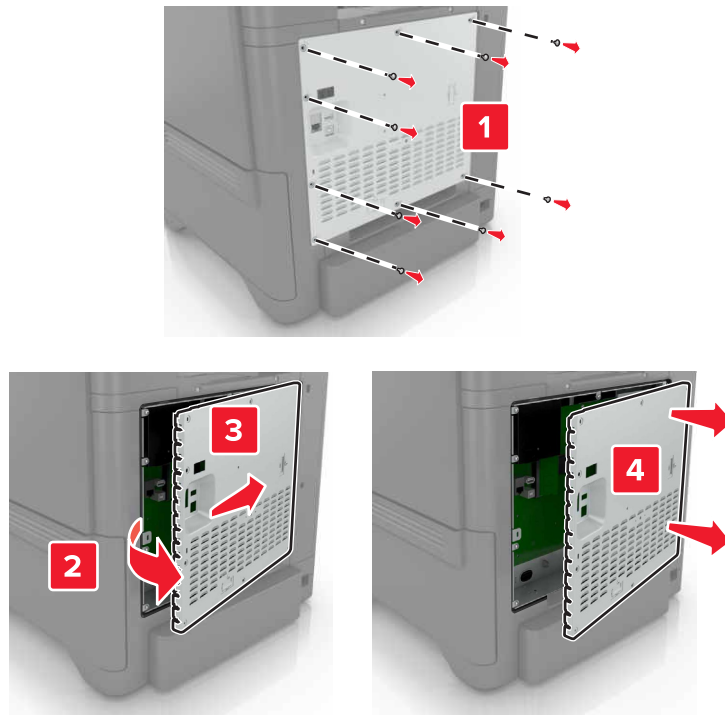

**3** Unpack the memory card.

**Warning—Potential Damage:** Avoid touching the connection points along the edge of the card.

**4** Insert the memory card until it *clicks* into place.

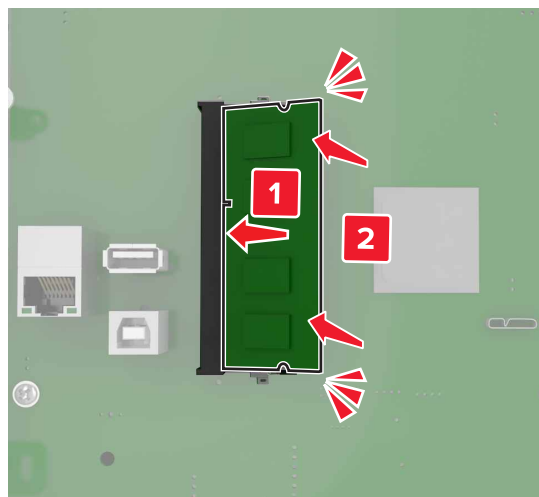

## 5 Reattach the access cover.

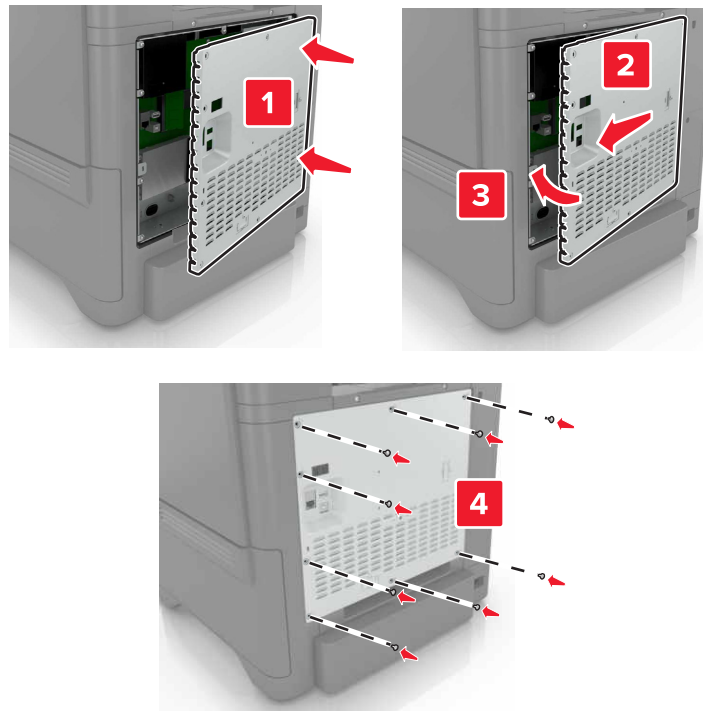

## 6 Connect the power cord to the electrical outlet, and then turn on the printer.

**CAUTION—POTENTIAL INJURY:** To avoid the risk of fire or electrical shock, connect the power cord to an appropriately rated and properly grounded electrical outlet that is near the product and easily accessible.

## Installing an internal solutions port

**CAUTION—SHOCK HAZARD:** To avoid the risk of electrical shock, if you are accessing the controller board or installing optional hardware or memory devices sometime after setting up the printer, then turn the printer off, and unplug the power cord from the electrical outlet before continuing. If you have any other devices attached to the printer, then turn them off as well, and unplug any cables going into the printer.

- 1 Turn off the printer, and then unplug the power cord from the electrical outlet.
- 2 Using a flat-head screwdriver, remove the controller board access cover.

**Warning—Potential Damage:** Controller board electronic components are easily damaged by static electricity. Touch a metal surface on the printer before touching any controller board electronic components or connectors.



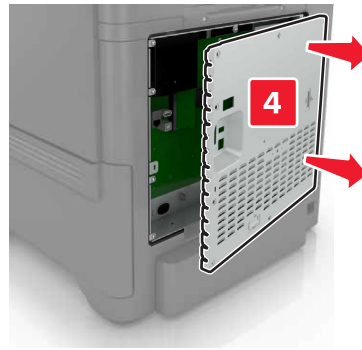
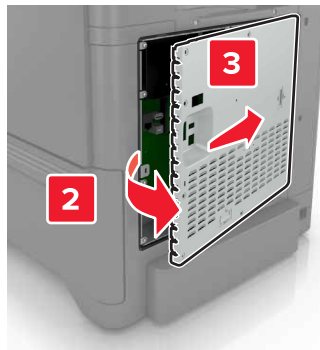
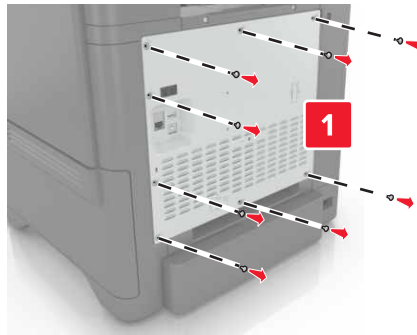

**3** Unpack the internal solutions port (ISP) kit.

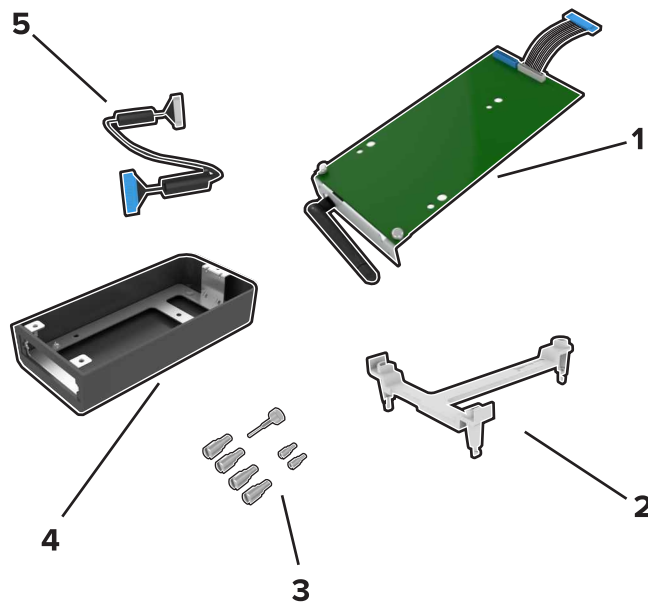

1	ISP
2	Mounting bracket
3	Thumbscrews
4	Housing

**5** ISP extended cable

**4** Install the ISP into its housing.

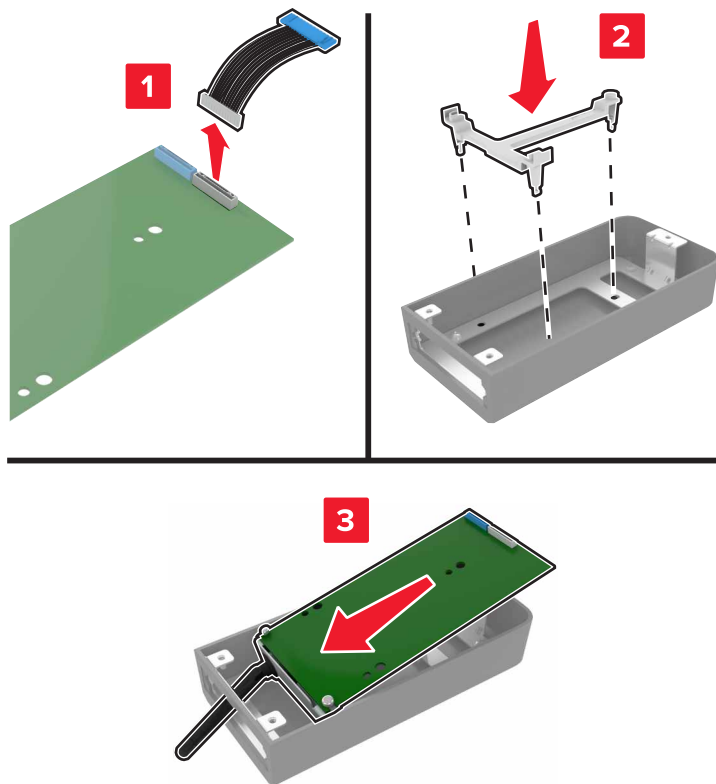

5 Attach the housing to the controller board access cover.

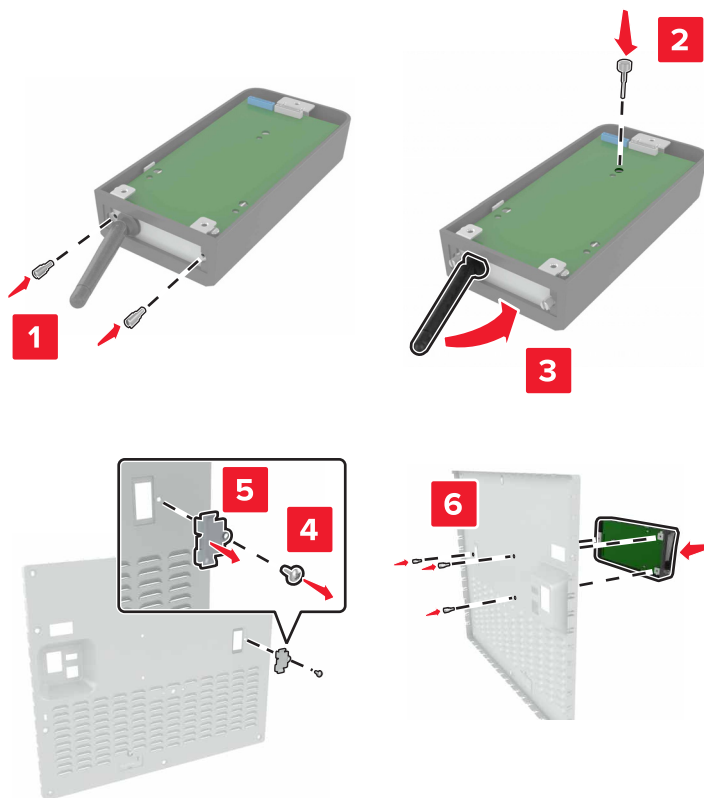

- 6 Connect the ISP extended cable to the ISP connector in the controller board.

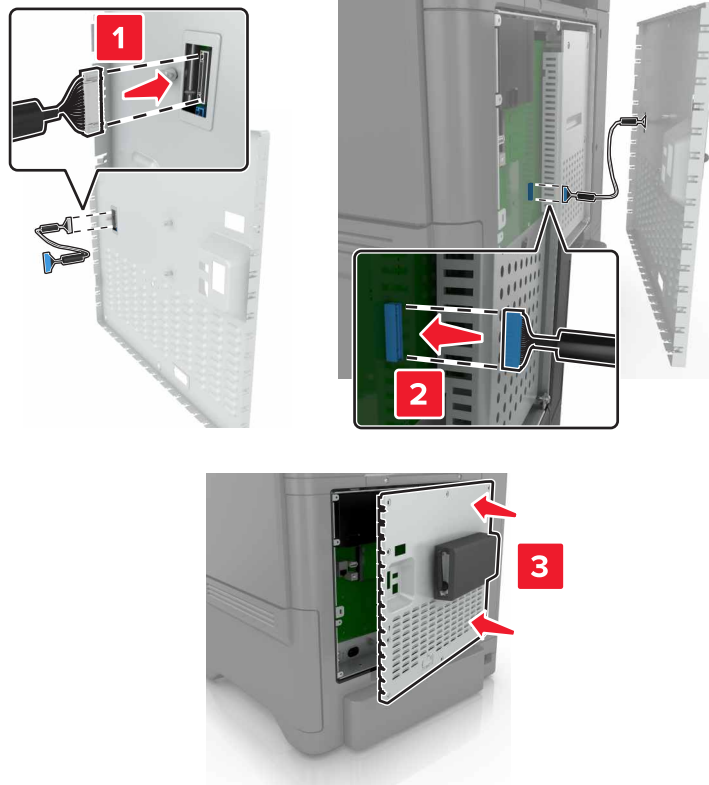

- 7 Reattach the controller board access cover.

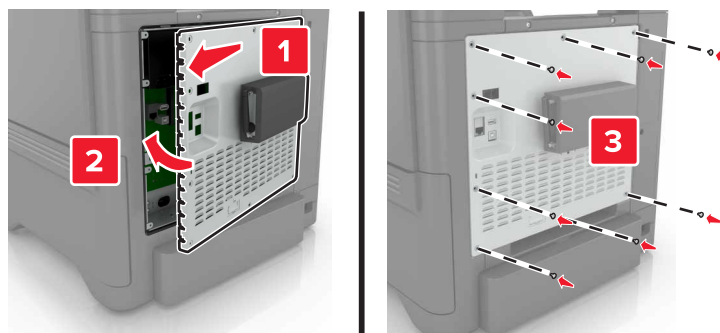

- 8 Connect the power cord to the electrical outlet, and then turn on the printer.

**⚠ CAUTION—POTENTIAL INJURY:** To avoid the risk of fire or electrical shock, connect the power cord to an appropriately rated and properly grounded electrical outlet that is near the product and easily accessible.

## Installing an optional card

**⚠ CAUTION—SHOCK HAZARD:** To avoid the risk of electrical shock, if you are accessing the controller board or installing optional hardware or memory devices sometime after setting up the printer, then turn the printer off, and unplug the power cord from the electrical outlet before continuing. If you have any other devices attached to the printer, then turn them off as well, and unplug any cables going into the printer.

- 1 Turn off the printer, and then unplug the power cord from the electrical outlet.
- 2 Using a flat-head screwdriver, remove the controller board access cover.

**Warning—Potential Damage:** Controller board electronic components are easily damaged by static electricity. Touch a metal surface on the printer before touching any components or connectors.

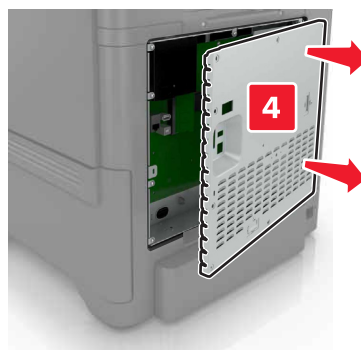
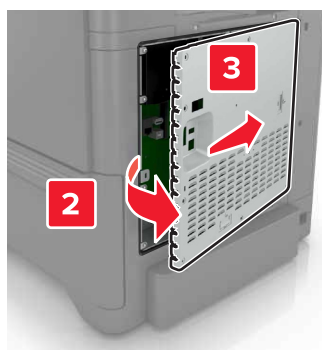
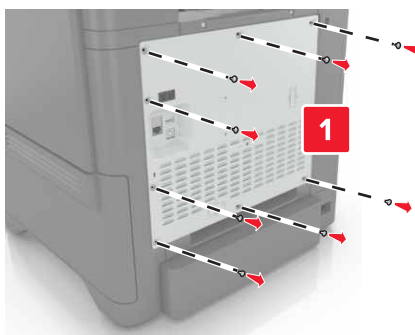

- 3 Unpack the optional card.

**Warning—Potential Damage:** Avoid touching the connection points along the edge of the card.

- 4 Push the card firmly into place.

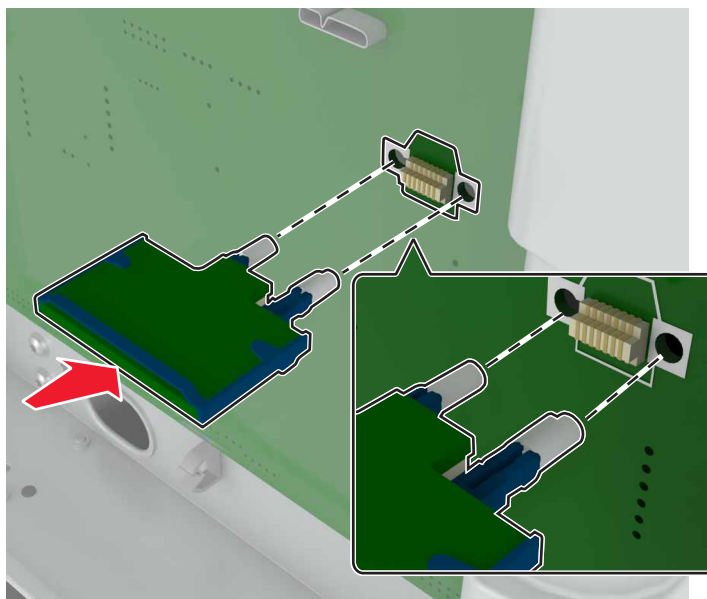

**Note:** The entire length of the connector on the card must touch and be flush against the controller board.

**Warning—Potential Damage:** Improper installation of the card may cause damage to the card and the controller board.

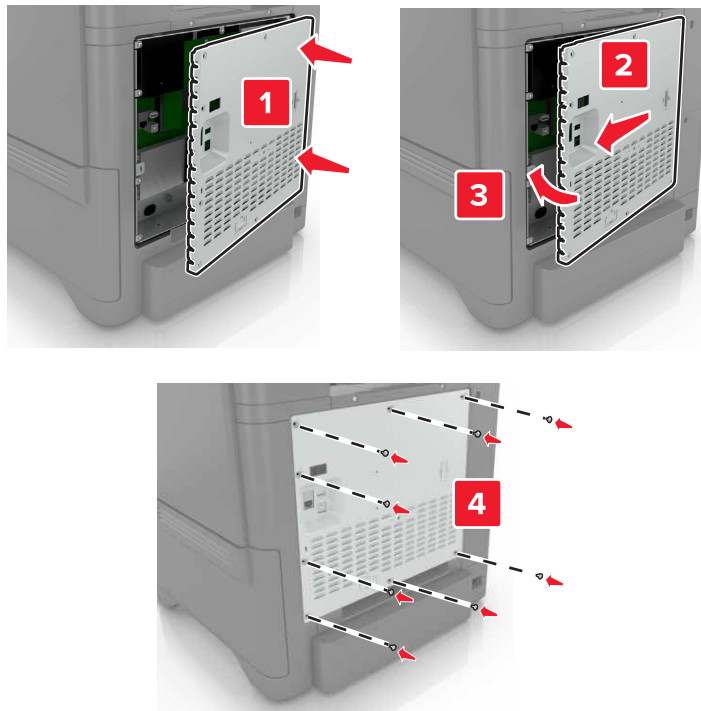
**5** Reattach the access cover.**6** Connect the power cord to the electrical outlet, and then turn on the printer.

**CAUTION—POTENTIAL INJURY:** To avoid the risk of fire or electrical shock, connect the power cord to an appropriately rated and properly grounded electrical outlet that is near the product and easily accessible.

## Installing a printer hard disk

**CAUTION—SHOCK HAZARD:** To avoid the risk of electrical shock, if you are accessing the controller board or installing optional hardware or memory devices sometime after setting up the printer, then turn the printer off, and unplug the power cord from the electrical outlet before continuing. If you have any other devices attached to the printer, then turn them off as well, and unplug any cables going into the printer.

- 1** Turn off the printer, and then unplug the power cord from the electrical outlet.
- 2** Using a flat-head screwdriver, remove the controller board access cover.

**Warning—Potential Damage:** Controller board electronic components are easily damaged by static electricity. Touch a metal surface on the printer before touching any controller board electronic components or connectors.

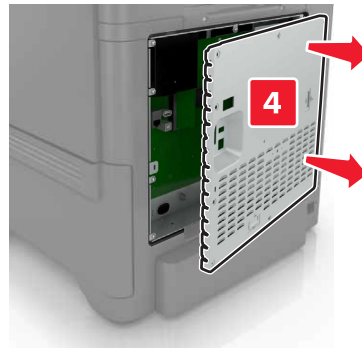
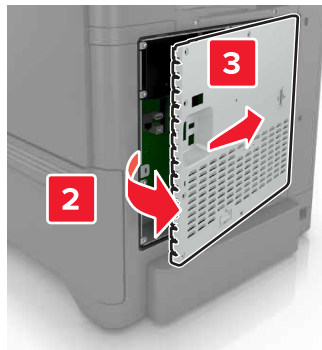
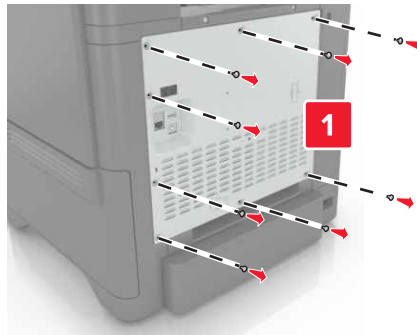

**3** Unpack the hard disk.

**4** Attach the hard disk to the controller board.

**Warning—Potential Damage:** Do not touch or press the center of the hard disk.

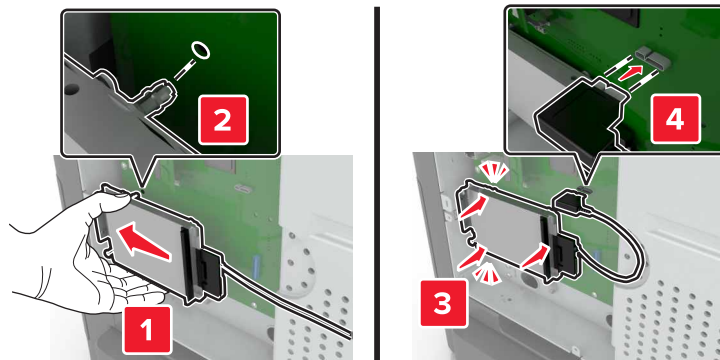



**5** Open door B.

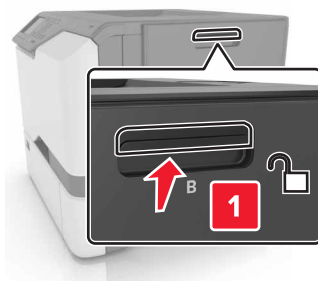

**6** Open door C.

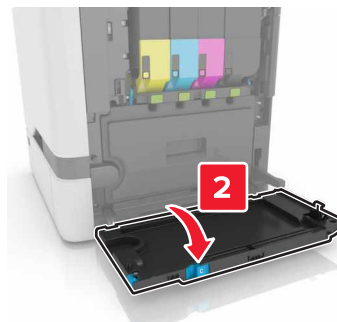
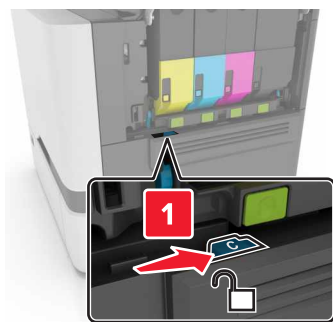

- 7 Secure the hard disk to the printer using the thumbscrews.

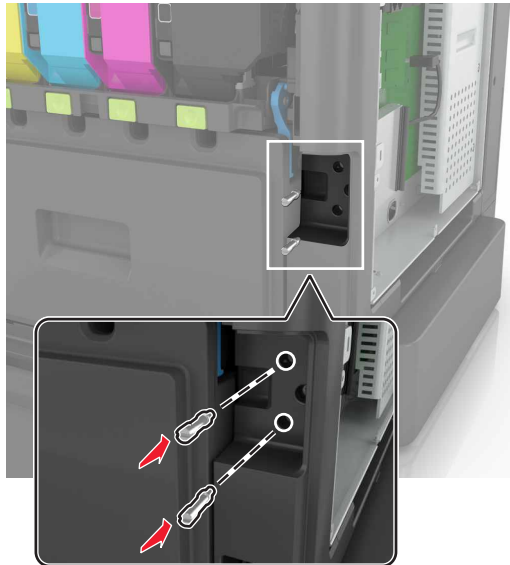

- 8 Close doors C and B.

- 9 Reattach the controller board access cover.

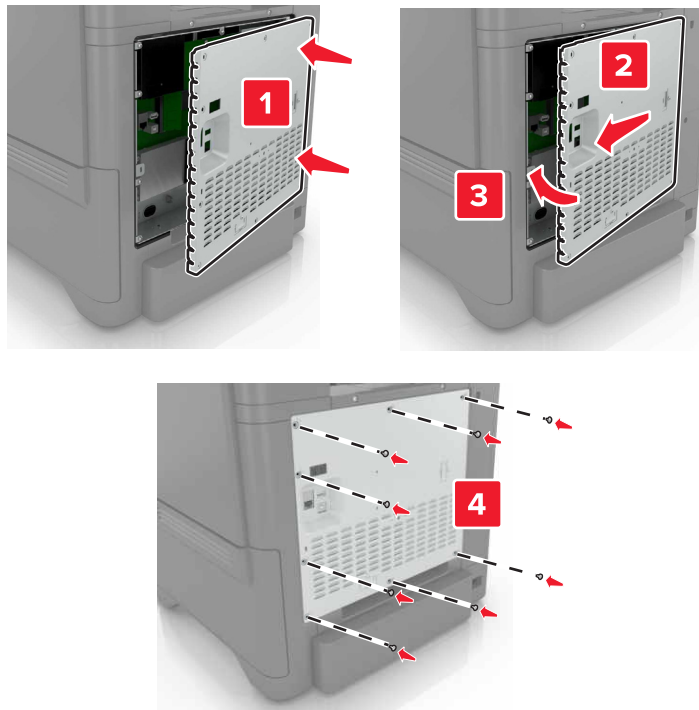

- 10 Connect the power cord to the electrical outlet, and then turn on the printer.

**⚠ CAUTION—POTENTIAL INJURY:** To avoid the risk of fire or electrical shock, connect the power cord to an appropriately rated and properly grounded electrical outlet that is near the product and easily accessible.

## Installing optional trays

**⚠ CAUTION—SHOCK HAZARD:** To avoid the risk of electrical shock, if you are accessing the controller board or installing optional hardware or memory devices sometime after setting up the printer, then turn the printer off, and unplug the power cord from the electrical outlet before continuing. If you have any other devices attached to the printer, then turn them off as well, and unplug any cables going into the printer.

- 1 Turn off the printer.
- 2 Unplug the power cord from the electrical outlet, and then from the printer.
- 3 Unpack the optional tray, and then remove all packing material.

**⚠ CAUTION—POTENTIAL INJURY:** The printer weight is greater than 18 kg (40 lb) and requires two or more trained personnel to lift it safely.

**Note:** If optional trays are already installed, then unlock them from the printer before lifting the printer. Do not try to lift the printer and trays at the same time.

- 4 Align the printer with the optional tray, and then lower the printer until it *clicks* into place.

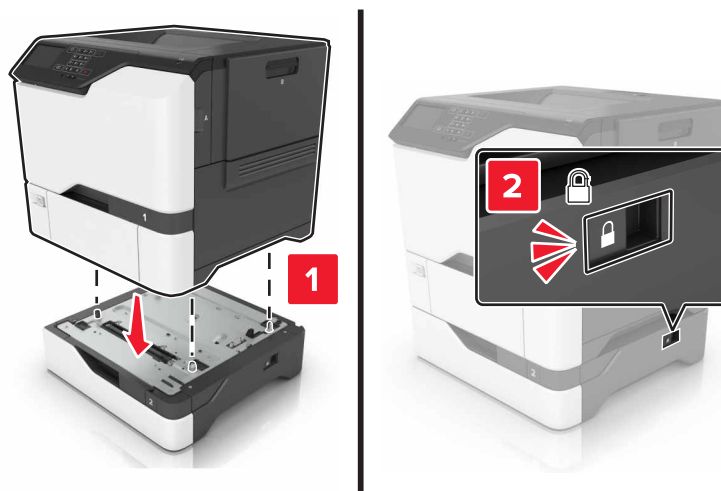

- 5 Connect the power cord to the printer, and then to the electrical outlet.

**⚠ CAUTION—POTENTIAL INJURY:** To avoid the risk of fire or electrical shock, connect the power cord to an appropriately rated and properly grounded electrical outlet that is near the product and easily accessible.

- 6 Turn on the printer.

If necessary, manually add the tray in the print driver to make it available for print jobs. For more information, see [“Adding available options in the print driver” on page 108](#).

Install the printer and hardware options in the following order:

- Optional 550-sheet tray
- Printer

## Software

### Installing the printer software

- 1 Obtain a copy of the software installer package.
- 2 Run the installer, and then follow the instructions on the computer screen.
- 3 For Macintosh users, add the printer.

**Note:** Obtain the printer IP address from the TCP/IP section in the Network/Ports menu.

### Adding available options in the print driver

#### For Windows users

- 1 Open the printers folder.
- 2 Select the printer you want to update, and then do either of the following:
  - For Windows 7 or later, select **Printer properties**.
  - For earlier versions, select **Properties**.
- 3 Navigate to the Configuration tab, and then select **Update Now - Ask Printer**.
- 4 Apply the changes.

#### For Macintosh users

- 1 From System Preferences in the Apple menu, navigate to your printer, and then select **Options & Supplies**.
- 2 Navigate to the list of hardware options, and then add any installed options.
- 3 Apply the changes.

## Firmware

### Exporting or importing a configuration file

You can export the configuration settings of your printer into a text file, and then import the file to apply the settings to other printers.

- 1 Open a Web browser, and then type the printer IP address in the address field.

**Notes:**

- View the printer IP address on the printer home screen. The IP address appears as four sets of numbers separated by periods, such as 123.123.123.123.
- If you are using a proxy server, then temporarily disable it to load the Web page correctly.

- 2 Export or import a configuration file for one or multiple applications.

**For one application**

- a** From the Embedded Web Server, click **Apps** > the application that you want > **Configure**.
- b** Click **Export** or **Import**.

**For multiple applications**

- a** From the Embedded Web Server, click **Export Configuration** or **Import Configuration**.
- b** Follow the instructions on the screen.

**Updating firmware**

Some applications require a minimum device firmware level to operate correctly.

For more information on updating the device firmware, contact your Lexmark representative.

- 1** From the Embedded Web Server, click **Settings** > **Device** > **Update Firmware**.
- 2** Browse to locate the required flash file.
- 3** Apply the changes.

# Notices

## Product information

Product name:

Lexmark CS720de, CS720dte, CS725de, CS725dte

Machine type:

5028

Model(s):

135, 630

## Edition notice

January 2016

**The following paragraph does not apply to any country where such provisions are inconsistent with local law:** LEXMARK INTERNATIONAL, INC., PROVIDES THIS PUBLICATION "AS IS" WITHOUT WARRANTY OF ANY KIND, EITHER EXPRESS OR IMPLIED, INCLUDING, BUT NOT LIMITED TO, THE IMPLIED WARRANTIES OF MERCHANTABILITY OR FITNESS FOR A PARTICULAR PURPOSE. Some states do not allow disclaimer of express or implied warranties in certain transactions; therefore, this statement may not apply to you.

This publication could include technical inaccuracies or typographical errors. Changes are periodically made to the information herein; these changes will be incorporated in later editions. Improvements or changes in the products or the programs described may be made at any time.

References in this publication to products, programs, or services do not imply that the manufacturer intends to make these available in all countries in which it operates. Any reference to a product, program, or service is not intended to state or imply that only that product, program, or service may be used. Any functionally equivalent product, program, or service that does not infringe any existing intellectual property right may be used instead. Evaluation and verification of operation in conjunction with other products, programs, or services, except those expressly designated by the manufacturer, are the user's responsibility.

For Lexmark technical support, visit <http://support.lexmark.com>.

For information on supplies and downloads, visit [www.lexmark.com](http://www.lexmark.com).

© 2016 Lexmark International, Inc.

All rights reserved.

## GOVERNMENT END USERS

The Software Program and any related documentation are "Commercial Items," as that term is defined in 48 C.F.R. 2.101, "Computer Software" and "Commercial Computer Software Documentation," as such terms are used in 48 C.F.R. 12.212 or 48 C.F.R. 227.7202, as applicable. Consistent with 48 C.F.R. 12.212 or 48 C.F.R. 227.7202-1 through 227.7207-4, as applicable, the Commercial Computer Software and Commercial Software Documentation are licensed to the U.S. Government end users (a) only as Commercial Items and (b) with only those rights as are granted to all other end users pursuant to the terms and conditions herein.

## Licensing notices

All licensing notices associated with this product can be viewed from the root directory of the installation software CD.

## Trademarks

Lexmark and the Lexmark logo are trademarks of Lexmark International, Inc., registered in the United States and/or other countries.

Mac and the Mac logo are trademarks of Apple Inc., registered in the U.S. and other countries.

Microsoft and Windows are either registered trademarks or trademarks of the Microsoft group of companies in the United States and other countries.

PCL® is a registered trademark of the Hewlett-Packard Company. PCL is Hewlett-Packard Company's designation of a set of printer commands (language) and functions included in its printer products. This printer is intended to be compatible with the PCL language. This means the printer recognizes PCL commands used in various application programs, and that the printer emulates the functions corresponding to the commands.

PostScript is a registered trademark of Adobe Systems Incorporated in the United States and/or other countries.

The following terms are trademarks or registered trademarks of these companies:

Albertus	The Monotype Corporation plc
Antique Olive	Monsieur Marcel OLIVE
Apple-Chancery	Apple Computer, Inc.
Arial	The Monotype Corporation plc
CG Times	Based on Times New Roman under license from The Monotype Corporation plc, is a product of Agfa Corporation
Chicago	Apple Computer, Inc.
Clarendon	Linotype-Hell AG and/or its subsidiaries
Eurostile	Nebiolo
Geneva	Apple Computer, Inc.
GillSans	The Monotype Corporation plc
Helvetica	Linotype-Hell AG and/or its subsidiaries
Hoefler	Jonathan Hoefler Type Foundry
ITC Avant Garde Gothic	International Typeface Corporation
ITC Bookman	International Typeface Corporation
ITC Mona Lisa	International Typeface Corporation
ITC Zapf Chancery	International Typeface Corporation
Joanna	The Monotype Corporation plc
Marigold	Arthur Baker
Monaco	Apple Computer, Inc.

New York	Apple Computer, Inc.
Oxford	Arthur Baker
Palatino	Linotype-Hell AG and/or its subsidiaries
Stempel Garamond	Linotype-Hell AG and/or its subsidiaries
Taffy	Agfa Corporation
Times New Roman	The Monotype Corporation plc
Univers	Linotype-Hell AG and/or its subsidiaries

All other trademarks are the property of their respective owners.

AirPrint and the AirPrint logo are trademarks of Apple, Inc.

### Noise emission levels

The following measurements were made in accordance with ISO 7779 and reported in conformance with ISO 9296.

**Note:** Some modes may not apply to your product.

1-meter average sound pressure, dBA	
Printing	One-sided: 51 (CS720); 53 (CS725) Two-sided: 53 (CS720); 55 (CS725)
Ready	15

Values are subject to change. See [www.lexmark.com](http://www.lexmark.com) for current values.

### Static sensitivity notice

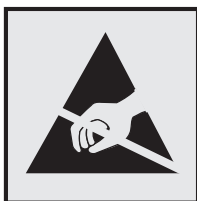

This symbol identifies static-sensitive parts. Do not touch the areas near these symbols without first touching a metal surface in an area away from the symbol.

### Temperature information

Operating temperature and relative humidity	10 to 32.2°C (50 to 90°F) and 15 to 80% RH 15.3 to 32.2°C (60 to 90°F) and 8 to 15% RH Maximum wet bulb temperature: 22.8°C (73°F)
Shipping temperature	-40 to 43.3°C (-40 to 110°F)
Storage temperature and relative humidity	1 to 35°C (34 to 95°F) 8 to 80% RH



## Laser notice

The printer is certified in the U.S. to conform to the requirements of DHHS 21 CFR, Chapter I, Subchapter J for Class I (1) laser products, and elsewhere is certified as a Class I laser product conforming to the requirements of IEC 60825-1.

Class I laser products are not considered to be hazardous. The printer contains internally a Class IIIb (3b) AIGalnP laser that is nominally 15-milliwatts operating in the wavelength region of 650–670 nanometers and enclosed in a non-serviceable printhead assembly. The laser system and printer are designed so there is never any human access to laser radiation above a Class I level during normal operation, user maintenance, or prescribed service conditions.

## Laser advisory label

A laser notice label may be affixed to this printer as shown:

DANGER - Invisible laser radiation when cartridges are removed and interlock defeated. Avoid exposure to laser beam.  
 PERIGO - Radiação a laser invisível será liberada se os cartuchos forem removidos e o lacre rompido. Evite a exposição aos feixes de laser.  
 Opasnost - Nevidljivo lasersko zračenje kada su kasete uklonjene i poništena sigurnosna veza. Izbjegavati izlaganje zracima.  
 NEBEZPEČÍ - Když jsou vyjmuty kazety a je odblokována pojistka, ze zařízení je vysíláno neviditelné laserové záření. Nevystavujte se působení laserového paprsku.  
 FARE - Usynlig laserstråling, når patroner fjernes, og spærreanordningen er slået fra. Undgå at blive udsat for laserstrålen.  
 GEVAAR - Onzichtbare laserstraling wanneer cartridges worden verwijderd en een vergrendeling wordt genegeerd. Voorkom blootstelling aan de laser.  
 DANGER - Rayonnements laser invisibles lors du retrait des cartouches et du déverrouillage des loquets. Éviter toute exposition au rayon laser.  
 VAARA - Näkymätöntä lasersäteilyä on varottava, kun värikasetit on poistettu ja lukitus on auki. Vältä lasersäteelle altistumista.  
 GEFAHR - Unsichtbare Laserstrahlung beim Herausnehmen von Druckkassetten und offener Sicherheitssperre. Laserstrahl meiden.  
 ΚΙΝΔΥΝΟΣ - Έκλυση αόρατης ακτινοβολίας laser κατά την αφαίρεση των κασετών και την απασφάλιση της μανδάλωσης. Αποφεύγετε την έκθεση στην ακτινοβολία laser.  
 VESZÉLY – Nem látható lézersugárzás fordulhat elő a patronok eltávolításakor és a zárószervezet felbontásakor. Kerülje a lézersugárnak való kitettséget.  
 PERICOLO - Emissione di radiazioni laser invisibili durante la rimozione delle cartucce e del blocco. Evitare l'esposizione al raggio laser.  
 FARE – Usynlig laserstråling når kassetene tas ut og sperren er satt ut av spill. Unngå eksponering for laserstrålen.  
 NIEBEZPIECZENSTWO - niewidzialne promieniowanie laserowe podczas usuwania kaset i blokady. Należy unikać naświetlenia promieniem lasera.  
 ОПАСНО! Невидимое лазерное излучение при извлеченных картриджах и снятии блокировки. Избегайте воздействия лазерных лучей.  
 Pozor – Nebezpečnostvo neviditeľného laserového žiarenia pri odobratých kazetách a odblokovanej poistke. Nevystavujte sa lúčom.  
 PELIGRO: Se producen radiaciones láser invisibles al extraer los cartuchos con el interbloqueo desactivado. Evite la exposición al haz de láser.  
 FARA – Osynlig laserstrålning när patroner tas ur och spärrmekanismen är upphävd. Undvik exponering för laserstrålen.  
 危険 - 当移除碳粉盒及互锁失效时会产生看不见的激光辐射, 请避免暴露在激光光束下。  
 危険 - 移除碳粉匣与安全連續開關失效時會產生看不見的雷射輻射。請避免暴露在雷射光束下。  
 危険 - カートリッジが取り外され、内部ロックが無効になると、見えないレーザー光が放射されます。このレーザー光に当たらないようにしてください。

# Index

## A

- adding hardware options
  - print driver 108
- adding internal options
  - print driver 108
- adjusting brightness of printer display 55
- adjusting toner darkness 90
- attaching cables 11
- available internal options 94
- avoiding paper jams 57

## B

- blank pages 75
- brightness of printer display
  - adjusting 55

## C

- canceling a print job
  - from the computer 26
  - from the printer control panel 26
- cannot open Embedded Web Server 65
- card stock
  - loading 20
- changing port settings
  - internal solutions port 30
- checking the printer connectivity 66
- checking the status of parts and supplies 31
- cleaning
  - exterior of the printer 31
  - interior of the printer 31
- cleaning the printer 31
- Color Correction
  - manual 91
- Color Correction Content 91
- color quality, troubleshooting
  - print appears tinted 92
- confidential print jobs 25
- configuring port settings 30
- connecting to a wireless network
  - using PIN method 29
  - using Push Button method 29

- conservation settings
  - Eco-Mode 55
  - hibernate mode 55
  - sleep mode 55
- conserving supplies 55
- contacting customer support 93
- control panel
  - using 12
- customer support
  - contacting 93

## D

- developer unit
  - replacing 38
- directory list
  - printing 26
- Display Customization
  - using 16
- disposing of printer hard disk 28
- documents, printing
  - from a computer 23

## E

- Eco-Mode setting 55
- Eco-Settings
  - using 17
- Embedded Web Server
  - problem accessing 65
- emission notices 112
- enabling the USB port 66
- encrypting the printer hard disk 27
- envelopes
  - loading 20
- environmental setting
  - Eco-Mode 55
- environmental settings
  - hibernate mode 55
  - sleep mode 55
- erasing printer hard disk memory 27
- Ethernet cable 11
- Ethernet port 11
- exporting a configuration file
  - using the Embedded Web Server 108

## F

- FAQ about color printing 91
- finding more information about the printer 8
- firmware
  - update 109
- firmware card 94
- flash drive
  - printing from 23
- font sample list
  - printing 25
- forms
  - printing 23
- Forms and Favorites
  - setting up 16
- fuser
  - replacing 44
- fuser maintenance kit
  - ordering 33

## G

- green settings
  - Eco-Mode 55
  - hibernate mode 55
  - sleep mode 55

## H

- hardware options
  - trays 107
- hardware options, adding
  - print driver 108
- held jobs 25
  - printing from a Macintosh computer 25
  - printing from Windows 25
- held print jobs
  - printing from a Macintosh computer 25
  - printing from Windows 25
- hibernate mode
  - setting 55
- home screen
  - customizing 16
  - showing icons 16
- home screen buttons
  - using 13
- horizontal dark lines 79

- I**
- icons on the home screen
    - showing 16
  - imaging kit
    - ordering 32
    - replacing 38
  - imaging unit
    - ordering 32
    - replacing 34
  - importing a configuration file
    - using the Embedded Web Server 108
  - indicator light
    - printer status 13
  - installing a memory card 94
  - installing a printer hard disk 103
  - installing an internal solutions port 96
  - installing an optional card 101
  - installing options
    - printer hard disk 103
  - installing printer 108
  - internal options 94
    - installing 101
    - memory card 94
  - internal options, adding
    - print driver 108
  - internal solutions port
    - installing 96
    - troubleshooting 68
- J**
- jam, clearing
    - multipurpose feeder 60
    - trays 59
  - jams
    - avoiding 57
    - locating jam areas 58
    - locations 58
  - jams, clearing
    - in the duplex unit 61
    - in the fuser 61
- L**
- light print 82
  - linking trays 21
  - loading
    - card stock 20
    - envelopes 20
    - multipurpose feeder 20
  - loading trays 18
- M**
- maintenance counter
    - resetting 54
  - manual Color Correction
    - applying 91
  - memory
    - types installed on printer 28
  - memory card 94
    - installing 94
  - menu settings page
    - printing 14
  - menus diagram 15
  - moving the printer 9, 54
  - multipurpose feeder
    - loading 20
- N**
- noise emission levels 112
  - non-volatile memory 28
    - erasing 27
  - notices 112, 113
- O**
- optional card
    - installing 101
  - options
    - firmware cards 94
    - internal solutions port 96
    - memory card 94
  - ordering
    - fuser maintenance kit 33
    - imaging kit 32
    - imaging unit 32
    - toner cartridges 32
    - transfer module 33
  - ordering supplies
    - waste toner bottle 33
- P**
- paper
    - Universal size setting 18
  - paper jam clearing
    - standard bin 60
  - paper jam in door A 61
  - paper jam in the multipurpose feeder 60
  - paper jam in the standard bin 60
  - paper jam in trays 59
  - paper jam, clearing
    - multipurpose feeder 60
    - trays 59
  - paper jams
    - avoiding 57
  - paper jams, clearing
    - in the duplex unit 61
    - in the fuser 61
  - paper size
    - setting 18
  - paper type
    - setting 18
  - parallel interface card
    - troubleshooting 68
  - parts status
    - checking 31
  - personal identification number method 29
  - pick roller
    - replacing 46
  - port settings
    - configuring 30
  - power button light
    - printer status 13
  - power cord socket 11
  - print driver
    - hardware options, adding 108
  - print job
    - canceling from the computer 26
    - canceling from the printer control panel 26
  - print quality
    - replacing imaging kit 38
  - print quality troubleshooting
    - blank pages 75
    - crooked print 84
    - dark print 76
    - ghost images appear on prints 77
    - gray background 78
    - horizontal dark lines 79
    - horizontal white lines 80
    - jagged or uneven characters 82
    - light print 82
    - repeating print defects 84
    - skewed print 84
    - solid color or black images 85
    - text or images cut off 86
    - toner easily rubs off 87
    - uneven print density 87
    - vertical dark lines or streaks appear on prints 88

- white pages 75
- print troubleshooting
  - collated printing does not work 69
  - confidential and other held documents do not print 72
  - envelope seals when printing 69
  - incorrect margins on prints 81
  - jammed pages are not reprinted 72
  - job prints from the wrong tray 90
  - job prints on the wrong paper 90
  - paper curl 70
  - paper frequently jams 71
  - print jobs do not print 74
  - slow printing 73
  - tray linking does not work 70
  - unable to read flash drive 66
- printer
  - basic model 10
  - fully configured 10
  - minimum clearances 9
  - moving 9, 54
  - selecting a location 9
  - shipping 54
- printer configurations 10
- printer display
  - adjusting the brightness 55
- printer hard disk
  - disposing of 28
  - encrypting 27
- printer hard disk encryption 27
- printer hard disk memory
  - erasing 27
- printer information
  - finding 8
- printer installation 108
- printer is not responding 89
- printer menus 15
- printer options troubleshooting
  - internal option is not detected 67
  - internal solutions port 68
  - parallel interface card 68
  - serial interface card 68
- printer ports 11
- printer settings
  - restoring to factory defaults 27

- printing
  - directory list 26
  - font sample list 25
  - from a computer 23
  - from a flash drive 23
  - menu settings page 14
- printing a directory list 26
- printing a font sample list 25
- printing a menu settings page 14
- printing a network setup page 66
- printing forms 23
- printing from a flash drive 23
- printing held jobs
  - from a Macintosh computer 25
  - from Windows 25
- Push Button method 29

## R

- recycling
  - Lexmark packaging 56
  - Lexmark products 55
  - toner cartridges 56
- repeat print jobs 25
  - printing from a Macintosh computer 25
  - printing from Windows 25
- repeating print defects 84
- replacing imaging unit 34
- replacing parts
  - pick roller 46
  - separator bracket 48
  - transfer module 50
- replacing the imaging kit 38
- replacing the pick roller 46
- replacing the separator bracket 48
- replacing the transfer module 50
- replacing the waste toner bottle 43
- replacing toner cartridge 42
- reserve print jobs
  - printing from a Macintosh computer 25
  - printing from Windows 25
- resetting the fuser page count 54
- resetting the maintenance counter 54
- resetting the transfer module page count 54

- restoring factory default settings 27

## S

- safety information 5, 6, 7
- selecting a location for the printer 9
- separator bracket
  - replacing 48
- serial interface card
  - troubleshooting 68
- serial printing
  - setting up 30
- setting hibernate mode 55
- setting sleep mode 55
- setting the paper size 18
- setting the paper type 18
- setting the Universal paper size 18
- setting up serial printing 30
- shipping the printer 54
- showing icons on the home screen 16
- statement of volatility 28
- storing print jobs 25
- supplies
  - conserving 55
- supplies status
  - checking 31
- supplies, ordering
  - imaging kit 32
  - imaging unit 32
  - toner cartridges 32
  - waste toner bottle 33
- supported file types 24
- supported flash drives 24

## T

- toner cartridge
  - replacing 42
- toner cartridges
  - ordering 32
  - recycling 56
- toner darkness
  - adjusting 90
- transfer module
  - ordering 33
  - replacing 50
- trays
  - installing 107
  - linking 21

- loading 18
- unlinking 21
- troubleshooting
  - cannot open Embedded Web Server 65
  - contacting customer support 93
  - FAQ about color printing 91
  - printer is not responding 89
  - troubleshooting, color quality
    - print appears tinted 92
  - troubleshooting, print
    - collated printing does not work 69
    - confidential and other held documents do not print 72
    - envelope seals when printing 69
    - incorrect margins on prints 81
    - jammed pages are not reprinted 72
    - job prints from the wrong tray 90
    - job prints on the wrong paper 90
    - paper curl 70
    - paper frequently jams 71
    - print jobs do not print 74
    - slow printing 73
    - tray linking does not work 70
  - troubleshooting, print quality
    - blank pages 75
    - crooked print 84
    - dark print 76
    - ghost images appear on prints 77
    - gray background 78
    - horizontal dark lines 79
    - horizontal white lines 80
    - jagged or uneven characters 82
    - light print 82
    - repeating print defects 84
    - skewed print 84
    - solid color or black images 85
    - text or images cut off 86
    - toner easily rubs off 87
    - uneven print density 87
    - vertical dark lines or streaks appear on prints 88
    - vertical white lines 88
    - white pages 75

- troubleshooting, printer options
  - internal option is not detected 67
  - internal solutions port 68

## U

- unable to read flash drive
  - troubleshooting, print 66
- understanding the status of the power button and indicator light 13
- uneven print density 87
- Universal paper size
  - setting 18
- unlinking trays 21
- updating firmware
  - flash file 109
- USB cable 11
- USB port 11
  - enabling 66
- using
  - genuine Lexmark parts 31
  - genuine Lexmark supplies 31
- using the control panel 12
- using the home screen 13

## V

- verify print jobs 25
  - printing from a Macintosh computer 25
  - printing from Windows 25
- vertical dark lines or streaks appear on prints 88
- vertical white lines 88
- volatile memory 28
  - erasing 27
- volatility
  - statement of 28

## W

- waste toner bottle
  - ordering 33
  - replacing 43
- white pages 75
- wireless network
  - Wi-Fi Protected Setup 29
- Wi-Fi Protected Setup
  - wireless network 29