



OWNER'S MANUAL

LG LED Screen

Please read this manual carefully before install & operating your set and retain it for future reference.

LAEC015-GN

www.lg.com

Copyright © 2020 LG Electronics Inc. All Rights Reserved.

TABLE OF CONTENTS

SAFETY PRECAUTIONS.....3

- Precautions for the AC Adapter and Power..... 4
- Precautions for Moving the Product.....6
- Precautions for Installing the Product.....7
- Precautions for Cleaning the Product.....9
- Precautions for Using the Product.....10
- Precautions for Using the Remote control.....12
- Precautions for Experiencing Image Retention.....13
- Product Disposal.....13

PREPARATION.....14

- Packing..... 14
- Setting.....17
- Remote Control18

ASSEMBLY 20

- General.....20
- Main Assemblies.....20
- Mechanical Assembly.....23
- Installation Guidelines.....25
- Electrical.....39
- Power Cable Wiring.....41

MAKING CONNECTIONS.....42

TROUBLESHOOTING45

PRODUCT SPECIFICATIONS.....50

LICENSES.....54

WARNING - This equipment is compliant with Class A of CISPR 32. In a residential environment this equipment may cause radio interference.

SAFETY PRECAUTIONS

The Safety Precautions are intended to prevent unexpected danger or harm by helping the user to use the product safely and for its intended purpose.

WARNING

If you ignore the warning message, you may be seriously injured or there is a possibility of accident or death.

CAUTION

If you ignore the caution message, you may be slightly injured or the product may be damaged.

WARNING

This product cannot be installed outdoors. Only use the product indoors as installed by the installer.

Precautions for the AC Adapter and Power

WARNING

- Use only the power cord or AC adapter provided or approved by LG Electronics, Inc. If you use another power cord, make sure that it is certified by the national standards. If the power cable is faulty in any way, please contact the manufacturer or the nearest authorized service center for a replacement.
- Operate the display only from a power source (i.e. voltage) indicated in the product specification.
 - Otherwise the product can be damaged, fire can occur or you may be electrocuted. If you are not sure what type of power supply you have, consult a certified installation company.
- Make sure the power cord connect to a properly grounded outlet.
 - If you do not you may be electrocuted or injured or the product can be damaged.
- Insert the power plug or AC adapter firmly so it cannot come loose.
 - Poor connection may cause a fire or electric shock.
- In the presence of thunder and lightning, never touch the power cord and signal cable because it can be very dangerous.
 - It can cause electric shock.
- Be careful not to step or place heavy objects (electronic appliances, clothing, etc.) on the power cord or AC adapter. Additionally, do not bend or pull out the power cord or AC adapter with excessive force.
 - Damaged power cords may cause a fire or electric shock.
- Do not connect power cord or AC adapter damaged with sharp objects to power outlet.
 - You may be electrocuted.
- Do not insert a conductor (like a metal chopstick) into one end of the power cord while the other end is connected to the input terminal on the wall. Additionally, do not touch the power cord right after unplugged.
 - You may be electrocuted.
- Do not use with a multi-outlet connected by many electrical product and heating devices. Use an exclusive multi-outlet with a grounding terminal.
 - A fire can break out due to overheating.

- If water or any foreign substance goes inside the product, disconnect the power cord immediately and contact the service center.
 - Otherwise, this may cause a fire or electric shock due to damage to the product.
- Keep the power cord or AC adapter away from any heating devices.
 - The cord coating may melt and cause fire or electric shock.
- Never disassemble, repair or modify the power cord or AC adapter.
 - This may cause a fire or electric shock.
- Please make sure the main power cutoff device is power cord and the product is installed near the wall outlet that is easily accessible.
- As long as this unit is connected to the AC wall outlet, it is not disconnected from the AC power source even if the unit is turned off.
- Power consumption will be '0' only when the power plug is unplugged.
- Use an appliance coupler as a disconnect device.

CAUTION

- If the outlet, pins of the power plug, or AC adapter is covered with dust, be sure wipe and keep clean.
 - Overheating due to layers of dust may cause a fire or electric shock.
- If the outlet, pins of the power plug, or AC adapter is covered with water, be sure wipe and keep clean. Additionally, Do not touch the power plug or AC adapter with wet hands.
 - This may cause an electric shock.
- Do not turn the product on or off by plugging in or unplugging the power plug from the power outlet. It means do not use the power plug as a switch.
 - This may cause an electric shock or product malfunction.
- Do not unplug the power cord while the product is in use.
 - Electrical shock can damage the product.

Precautions for Moving the Product

WARNING

- Contact the service center before moving the product.
 - It may cause electric shock and damage the product.
- Make sure the product is turned off, unplugged, and all cables have been removed before the product is moved.
 - You may be electrocuted or the product can be damaged.
- When moving the product, Do not shock the product and impact on the front panel of the product.
 - You may be electrocuted or the product can be damaged.
- Comply with the number of people according to weight of product. (Under 25 kg per person, use the equipment when exceed 100 kg)
 - If use the damaged product again, contact the service center because it can cause electric shock or fire.
- Do not hold it upside down while holding only the stand. (It is for stand supported models only.)
 - This may cause stand warping, panel damage and other types of product damage.

CAUTION

- Do not dispose the product-packing box. It may be used put the product in the box when carrying it.

Precautions for Installing the Product

WARNING

- Contact the service center before installing the product.
 - It can cause electric shock and damage the product.
- Do not drop an object on or impact on the product. Keep out of reach of children and do not place toys or objects near the product to prevent throwing things on the product screen.
 - It can cause injury to human, problem to product and damage the display.
- Do not put heavy objects on, or hang from, the product.
 - If the product collapses or is dropped, you may be injured.
- Do not touch the surface of product to overheat.
 - It can cause injury to human.
- Install the product firmly fixed on a floor, wall, etc. to prepare against external impact such as wind and earthquake.
 - You must refer to the manual provided.
- Prevent Children from climbing or hanging on the product.
 - If the product collapses or is dropped, you may be injured.
- Do not install it where there are heating devices such as electrical heaters or lighting equipment.
 - Fire, electrical shock, malfunction may occur.
- Do not install this product by yourself as you may injure yourself or cause damage to product. Please contact service engineer authorized by service center.
- Do not install this product on a wall if it could be exposed to oil or oil mist.
 - This may damage the product and cause it to fall.
- Do not leave the power or signal cable, etc. on the pathway.
 - This could cause a trip or fall, which can be caused electrical shock, fire, product breakdown, or injury.
- Do not let the product drop when connecting it to an external device connected with a short cable.
 - This may cause injury and damage to the product.
- If you dropped the product or the case is broken, turn off the product and unplug the power cord and contact the service center.
 - If you continue to use without taking proper measures, electrical shock or fire can occur.
- Install the product in a dry place where it is not near dust and water. Avoid high temperatures and humidity.
 - This may cause electrical shock, fire or product damage.
- Safely install the product in a place that can hold the weight of the product.
 - A lack of strength may cause the product to fall.
- Take a comfortable and natural position to relax the muscles when working with a product.
- Caution to prevent damage to the LED from static. Do not touch the product without anti-static gloves.

 **CAUTION**

- Install the product where no Electromagnetic Interference occurs.
- If you install the product in a place that does not meet the recommended conditions, this may cause serious damage to the product's picture quality, life cycle, and appearance. Please check with service engineer before installing. Please do not install the product in places such as where there is an abundance of fine dust or oil mist, chemical substances are used, exposed to direct sunlight, the temperature is very high or low, the humidity is very high.
- Make sure the product is well ventilated by installing at a distance (100 mm or more) from the wall.
 - If you install the product too close to the wall, it may be deformed or fire can break out due to internal heat buildup.
- Do not cover the product with tablecloth or curtain or other material (eg. plastic) while plugged in to block the ventilation hole of the product.
 - The product can be deformed or fire can break out due to overheating inside the product.
- Do not install the product in an area with poor ventilation (e.g. on a bookshelf, in a closet) or outside and avoid placing on cushions or carpets.
 - The product could catch fire due to overheating inside the product.
- Install the product on a flat and stable place that is large enough to support the product.
 - If the product is dropped, you may be injured or the product may be broken.
- When installing the product on a shelf or cabinet, make sure that the bottom end of the product is not protruding forward.
 - The product may fall due to unbalanced center of gravity, which may cause personal injury or damage to the product. Be sure to use cabinets or shelves that fit your product.

Precautions for Cleaning the Product

WARNING

- Keep the product clean at all times.
 - If you don't clean the unit for a long time and it becomes covered in dust, it can cause fire or product damage.
- When you need to clean the inside of the product, you must contact the service center.
 - Otherwise, cleaning without support may cause a fire, electric shock, or damage to the product.
- When cleaning the product, unplug the power cord and wipe gently with a soft cloth to prevent scratching.
 - An electric shock may occur or damage to the screen as get a scratch.
- When you want to clean the front frame, spray water onto a soft cloth 2 to 4 times and wipe in one direction only.
 - Too much moisture may cause staining.
- Do not physically come in contact with the screen of the LED Package.
 - This may cause damage to the product.
- To clean the product, use an air gun to lightly remove dust from the front frame and the screen.
 - If there are foreign substances in between the LEDs on the screen, it may cause a defect in the screen.

CAUTION

- When cleaning the product or the screen, unplug the power cord and wipe it gently with a soft cloth. Do not spray water or other liquids directly on the product. Especially, do not clean your product with chemicals including glass cleaner, any type of air freshener, insecticide, lubricants, wax (car, industrial), abrasive, thinner, benzene, alcohol, etc., which can damage the product or its panel.
 - This may result in fire, electric shock or product damage (deformation, corrosion or breakage).

Precautions for Using the Product

WARNING

- Do not use the product in any environment with excessively high temperatures or humidity.
- If you use the product for a long period of time, take a rest from time to time to protect your vision.
 - Extended viewing could result in impaired vision.
- Listening at high volume or using for a long time can cause damage to your hearing.
- In the event that liquid or a foreign object falls into the product, please switch it off and unplug it from the wall outlet and contact the service center.
 - Otherwise, the product may cause fire or electric shock.
- In the event that no image appears on the screen or no sound is heard, stop using the product. Switch it off immediately, unplug it from the power outlet and contact the service center.
 - Otherwise, the product may cause fire or electric shock.
- Do not drop an object or impact on the product or screen.
 - It can cause injury to human, problem to product and damage the screen.
- If you can smell smoke or other odors or hear a strange sound, unplug the power cord and contact the service center.
 - If you continue to use the product without taking proper measures, it may cause electrical shock or fire.
- Do not attempt to disassemble, repair or modify the product yourself. Please contact service center if you need to repair it.
 - Fire or electric shock can occur.
- Do not place objects filled with liquids, such as vases, cups, etc. on over of the product to prevent liquid from entering the product.
 - Failure to do so may result in fire, electric shock, malfunction or deformation.
- Do not push hard on or scratch the product's surface with your hands or sharp objects, such as nails, pencils or pens. Do not shock or scratch the front and sides of the screen with metallic objects.
 - This may damage the products and cause it to malfunction.
- Do not touch the product if it has been exposed to sunlight or an intense light because it could be hot.

- Do not use high voltage electrical goods near the product (e.g., a bug zapper).
 - This may result in product malfunction if it receives an electrical shock.
- If there is a gas leak, do not touch the outlet, and open the windows for ventilation.
 - Otherwise, the product may cause fire or electric shock.
- If you dropped the product or the case is broken, turn off the product and unplug the power cord.
 - If you continue to use without taking proper measures, electrical shock or fire can occur. Contact the service center.
- Keep small accessories out of the reach of children.
 - If a child swallows it, consult a doctor immediately.
- Keep out of reach of children from the product. Also, do not throw toys or objects to the product or screen.
 - It can cause injury to human, problem to product and damage the screen.
- All the power sources must be disconnected by removing the power cables to remove all power from the unit.

CAUTION

- This panel is an advanced product that contains millions of pixels. You may occasionally see pixel spots when viewing the screen. Since these deactivated pixels are not a defect, the performance and reliability of the product is not affected.
- Do not put or store inflammable substances near the product.
 - There is a danger of explosion or fire.
- Keep the proper distance from the product.
 - It can cause damage to your vision if you look at the product too closely.
- Set the appropriate resolution and frequency by products.
 - It can cause damage to your vision.
- Take a regular break when working with the product for a long time.

Precautions for Using the Remote control

WARNING

- Avoid places with high humidity.
 - It may cause electrical shock or damage the product.
- Do not expose batteries to excessive heat, such as direct sunlight, open fireplace, and electric heaters.
 - It may cause fire and you may be injured.
- Make sure that children do not swallow the remote control batteries when you replace them. Keep batteries out of reach of children.
 - If a child swallows a battery, consult a doctor immediately.
- Do not dispose of batteries in a fire.
 - Please dispose batteries at a local recycling center or a retail store that handles batteries.
- Used batteries, which include rechargeable batteries, should be recycled separately from waste.
 - Please dispose used batteries and rechargeable batteries at a local recycling center or a retail store that handles batteries.

CAUTION

- Do not short circuit and disassemble of batteries.
 - It may cause electrical shock or fire.
- The remote control may not function properly in sunlight or under a strong lamp. Move the product if it is being used in these conditions.
- Check if there is any obstacle between the product and the remote control.
- Do not mix new batteries with old batteries.
 - Overheating or leaking batteries may cause fire or electric shock.
- Only use the specified type of battery. Do not insert batteries that are not rechargeable into the charger.
 - Overheating or leaking batteries may cause fire or electric shock.

Precautions for Experiencing Image Retention

- Displaying a still image for a prolonged period of time may cause damage to the screen, resulting in image retention. Most third-party products have the same issue. The resulting damage is not covered by the product warranty.
 - Use a screen saver when using the monitor for a prolonged period of time.

Product Disposal

- Do not dispose of this product with general household waste.
- Disposal of this product must be carried out in accordance to the regulations of your local authority.

PREPARATION

Packaging

NOTE: The pictures are schematic diagrams. Everything is subject to the in fact products.



Flight Case

1. Pack up the LDMs.

Pack up six LDMs into an antistatic carton separately and set them into the carton. (Pack up all the LDMs in this way. Seal the cartons. Then put the cartons into the flight case.



2. Pack up the mounting plate.



3. Pack up the cabinet and put them into the flight case.



Setting

The introduction of LAEC015-GN screen interface and function

1. Remote Controller



2. Interface and Button Specifications

NOTE: The volume buttons are not placed on the cabinet. It can only be controlled by the remote controller.

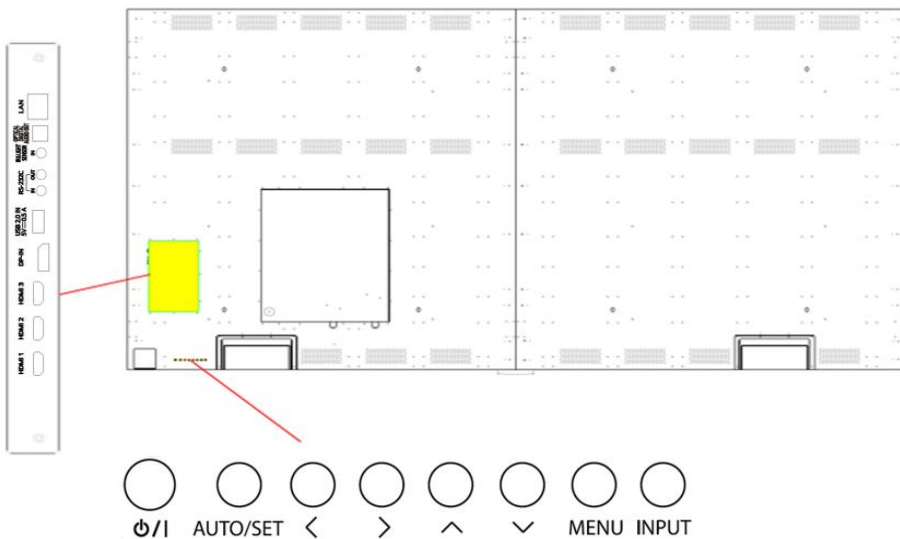

- **⏻/I**: Turns the power on or off.
- **AUTO/SET**: Displays the current signal and mode.
- **<>**: Moves left and right.
- **^ v**: Adjust the up and down.
- **MENU**: Accesses the main menus, or saves your input and exits the menus.
- **INPUT**: Changes the input source.

REMOTE CONTROL

The descriptions in this manual are based on the buttons on the remote control. Please read this manual carefully to use the monitor correctly. To install batteries, open the battery cover, place batteries (1.5 V AAA) matching \oplus and \ominus terminals to the labels inside the compartment, and close the battery cover. To remove the batteries, perform the installation actions in reverse. The illustrations may differ from the actual accessories.

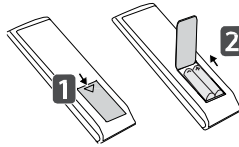

CAUTION

- Do not mix old and new batteries, as this may damage the remote control.
- Be sure to point the remote control toward the remote control sensor on the monitor.
- Some features of the remote control may not be supported in certain models.
- The product's internal and external batteries should not be exposed to excessive heat such as direct sunlight, fire, or the like.

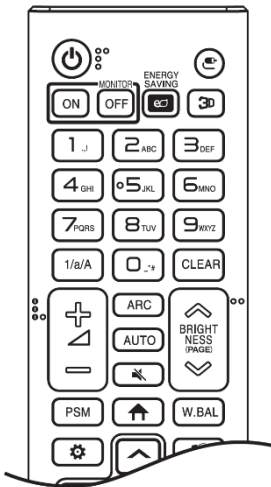

⏻ (POWER) Turns the monitor on or off.

MONITOR ON Turns the monitor on.

MONITOR OFF Turns the monitor off.

ENERGY SAVING Adjusts the brightness of the picture to reduce energy consumption.

⏻ (INPUT) Selects the input mode.

3D Turns the display layout pattern on.

Number and Alphabet buttons Enters numerical or alphabetical characters depending upon the setting.

1/a/A Toggles between numerical and alphabetical.

CLEAR Deletes the entered numerical or alphabetical character.

⏮/⏭ (Volume Up/Down Button) Adjusts the volume.

ARC Selects the Aspect Ratio mode.

AUTO Automatically adjusts picture position and minimizes image instability (available for RGB input only).

🔇 (MUTE) Mutes all sounds.

BRIGHTNESS Adjusts the brightness of the display.

PAGE The function is not supported in this model.

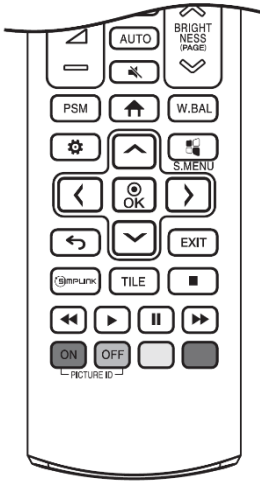

PSM Selects the Picture Mode.

↑ (HOME) Activates the Launcher.

W.BAL Enters the White Balance menu.

⚙️ (SETTINGS) Accesses the main menus or saves your input and exit menus.

S.MENU SuperSign menu key.

← ↓ → (**Navigation Buttons**) Scrolls through menus or options.

⊙ OK Selects menus or options and confirms your input.

↶ (BACK) Allows you to move back one step in the user interaction function.

EXIT Quit all OSD tasks and applications.

SIMPLINK Allows you to control various multimedia devices to enjoy multimedia simply by using the remote control through the Simplink menu.

TILE Selects the TILE Mode.

PICTURE ID ON/OFF When the Picture ID number matches the Set ID number, you can control whichever monitor you want in multi-display format.

▶ ◀ ▶ ◻ ▶▶ (**USB Menu Control Buttons**) Controls media playback. (May not be supported on some models.)

ASSEMBLY

General

This manual provides an overview of the LAEC015-GN LED display system, the main system components and interconnection methods. If any details in this document are unclear, please contact your local representative, or the head office for more details.

Brief Description of Purpose and Operation of System

The LAEC015-GN LED display system is designed for indoor use, where a high quality dynamic image is to be made visible to large numbers of people. The panel size is designed from the beginning according to end-user requirements.

Main Assemblies

LAEC015-GN Panel Assembly

Each LAEC015-GN LED panel comprises an outer cladding panel with integral aluminum framework for increased rigidity and a central stacker for the fast rigging. The panel is designed to be mounted to a fixed framework.

The listing in Table 2.1 is the main components of a LAEC015-GN LED panel. The profile of the panel is shown in Figure 2.1.

Component Placement and main components

There are five kinds of system board worked for the LED display, IR Receiver Board, Power and Mini Card Converter Board, I/O Board, LAEC controller Board and Power Board. Please refer to the description for each board in the following sections.

LAEC015-GN LED display is combined with LDM and case. The LDMs and case are fixed by magnetic structure.

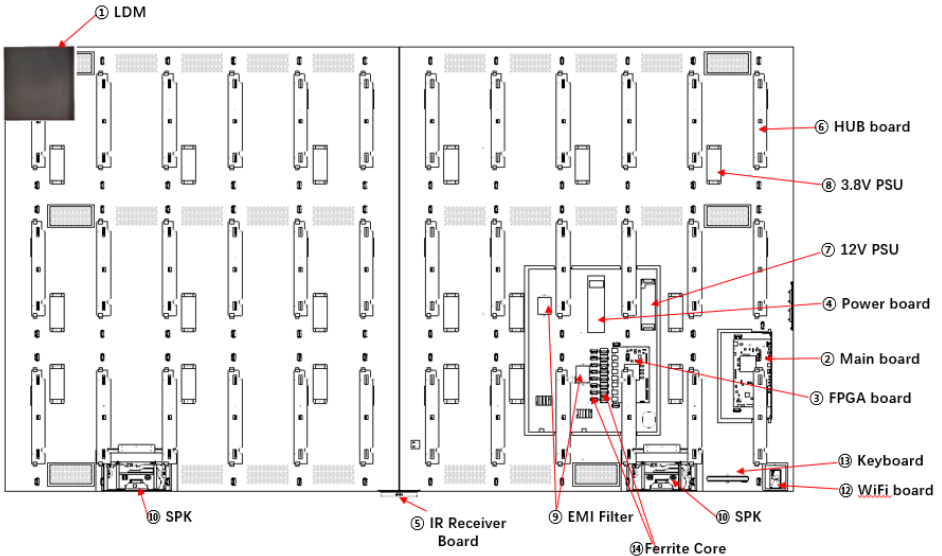

Figure 2.1 Major components placement for LAEC015-GN

Item	Description	Qty
1	LED Display Modules (LDM)	72
2	Main Board	1
3	FPGA Board	1
4	Power Board	1
5	IR Receiver Board	1
6	Power and Mini Card Converter Board(2 in 1)	36
7	12V/200W Switched Mode Power Supply	1
8	3.8V/189W Switched Mode Power Supply	18
9	EMI / RFI AC power line filter	2
10	Intelligent SPK	2
11	IR Remote	1
12	Wi-Fi/BT Board	1
13	Key Board	1
14	Ferrite Core(84 small +8 big)	92

Note: The PSU output is adjustable, the actual value would subject to the label of manufacturing data

Table 2.1 - Major components of LAEC015-GN LED panel assembly

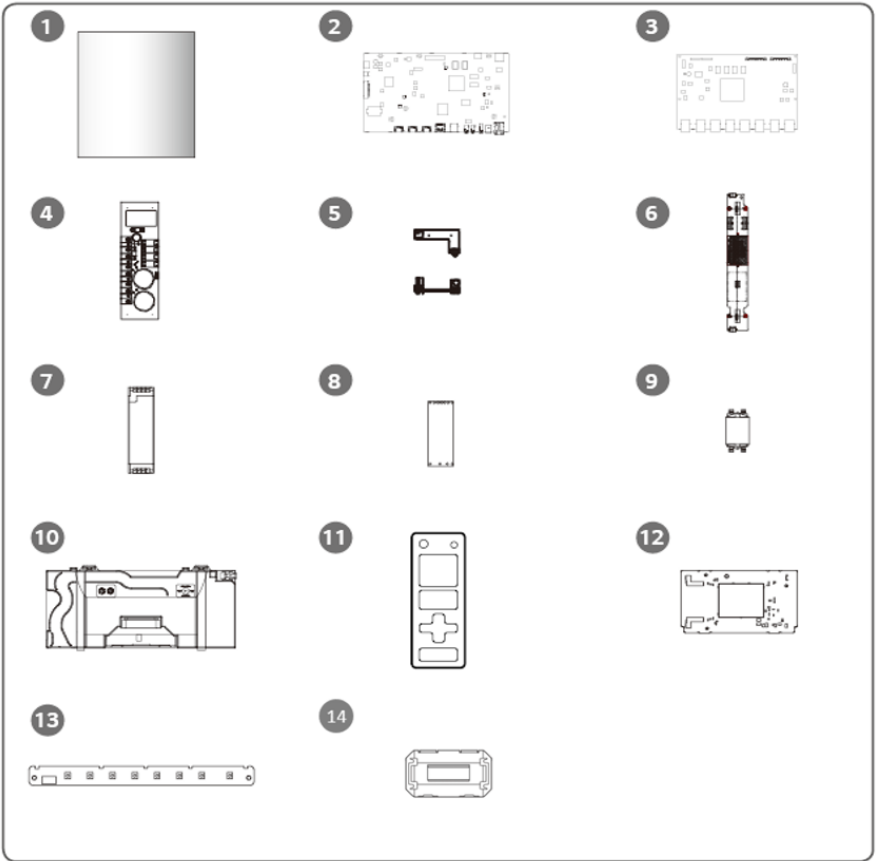
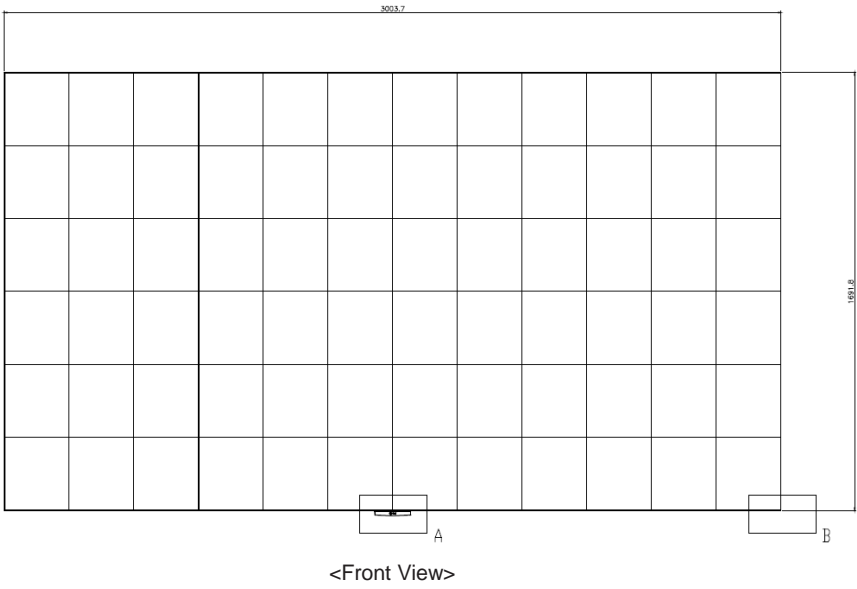
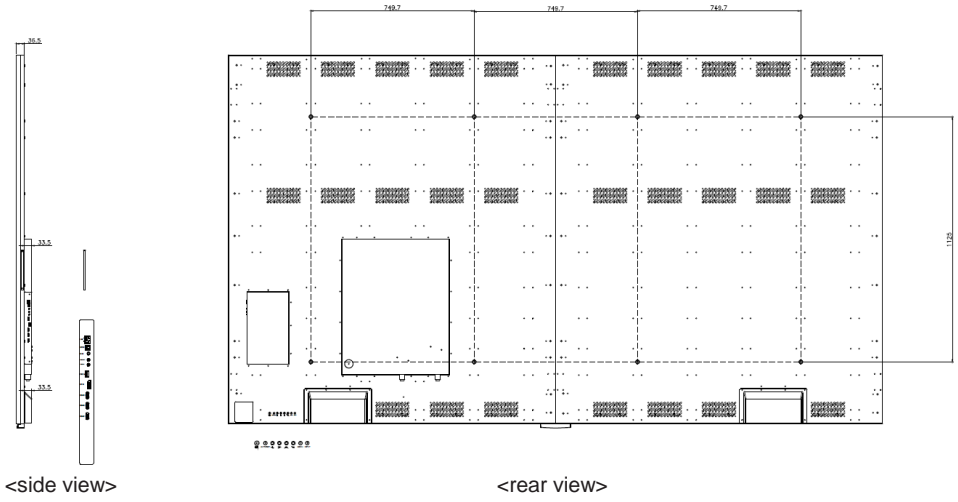

Figure 2.2 Major components of LAEC015-GN LED panel assembly

MECHANICAL ASSEMBLY



LED Display Module (LDM)

The front face of the LAEC015-GN LED display is fitted with 72 light emitting diode (LED) dot LED modules known as LDMs. Each LMD is fitted with 28880 LEDs* plus associated drive electronics. Electrical connections (low voltage power, and digital data) are made to the rear of each LDM, from inside of the enclosure.

Figures 3 and 4 are showing the front and rear views of an LAEC015-GN LDM.

* Remark: each LDM contains 160x180 pixels (row x column) and each pixel is composed by 3 in 1 LEDs, so there are totally 28800 LEDs fitted on the front face of an LDM.

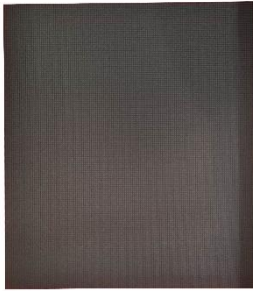

Figures 3. LDM - front view

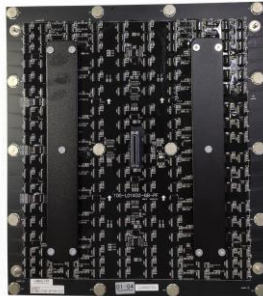

Figures 4. LDM - rear view

Installation Guidelines

The LAEC015-GN LED display, each LDM is equipped with 4 pcs guide pin, are fixed with magnetic structure and jointed together both vertically and horizontally, so that they can form one surface of screen-configuration.

The LAEC015-GN LED display is designed to be mounted on the stand (sold separately) or on the wall. When installing, it is important to ensure that the entire screen is correctly aligned, both vertically and horizontally.

Installation

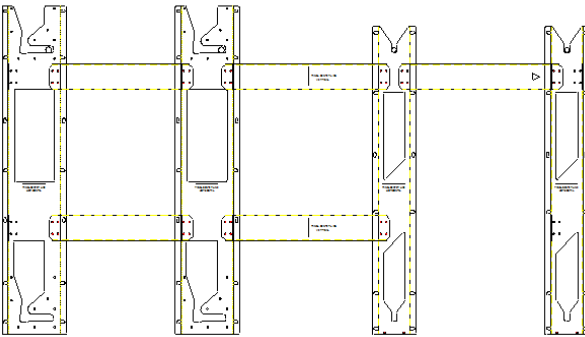







Figures 5. Wall Mount front view

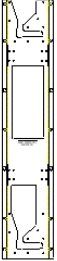

Figures 6. LAEC015-GN front view

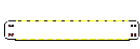
1) Mounting Plate Installation

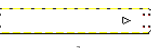
Wall mount piece list

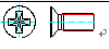
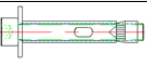
Item	Photo	Qty	Description	Item	Photo	Qty	Description
1		2	Left plate	2		2	Right plate
3		2	Left connection plate	4		2	Middle connection plate
5		1	Right connection plate	6		1	Bottom connection plate
7		44	Flat head screw M3X12	8		32	M8x60 expansion screw

Step1. Install the left plate with connection plate .

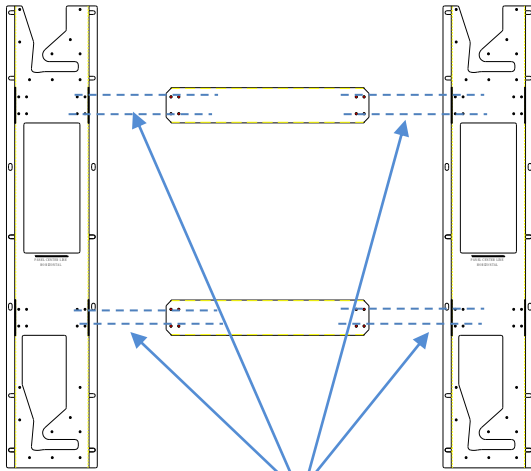

Use 16pcs M3X12 screw (item 7) to install the left plate (item 1) with left connection plate(item3).

Step2. Install the right plate with connection plate.

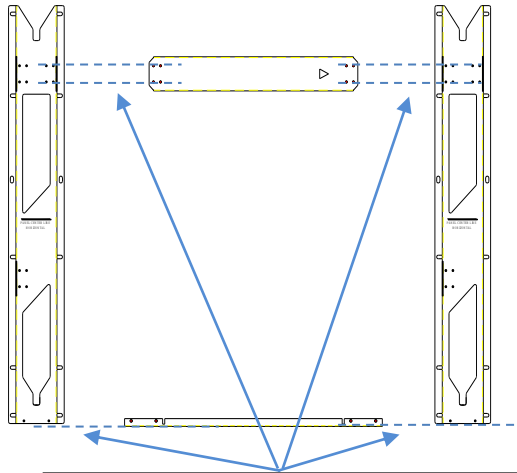

Use 12pcs M3X12 screw (item 7) to install the right plate (item2) with right connection plate and bottom connection plate(item5/item6).

Step3. Connect the left assembly and right assembly by intermediate plate.

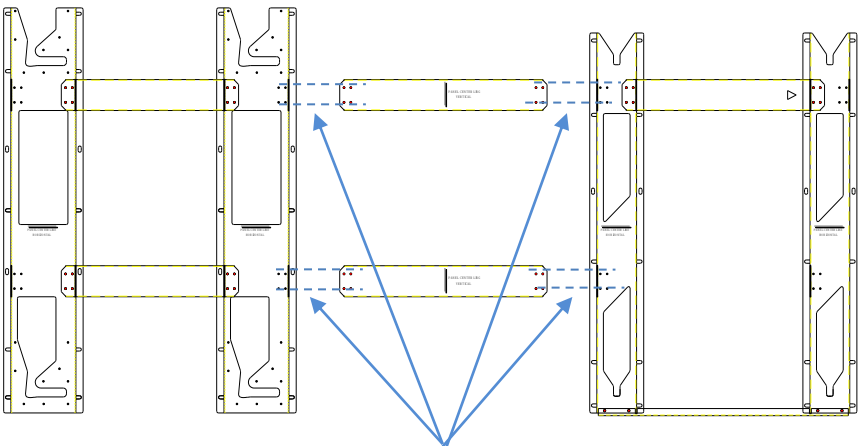

Use 16pcs M3X12 screw (item 7), to install the left assembly and right assembly together.

Step4. Double check the dimension after assembling. Install the mounting plate to the desired location and secure them with 32 pcs M8x60 explosion screws.

(The following locations which should be installed the screws are marked in circle. The depth is about 60-65mm)

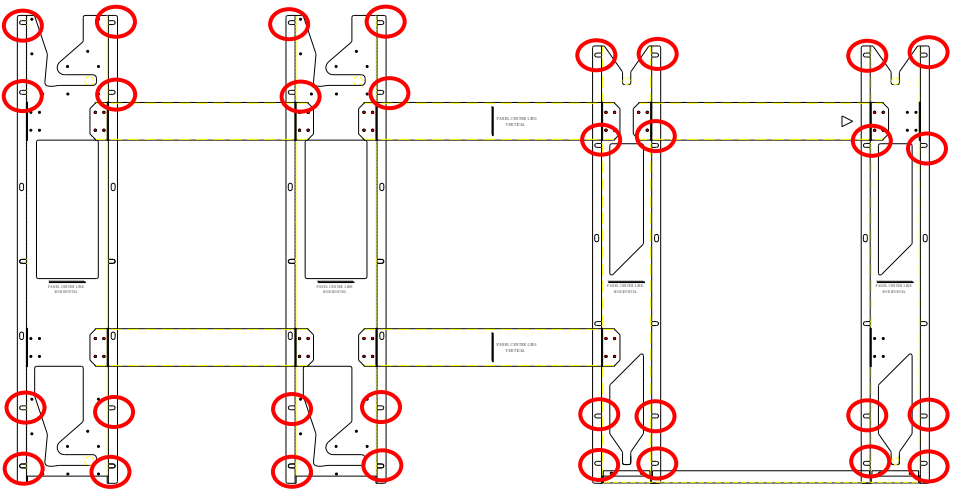
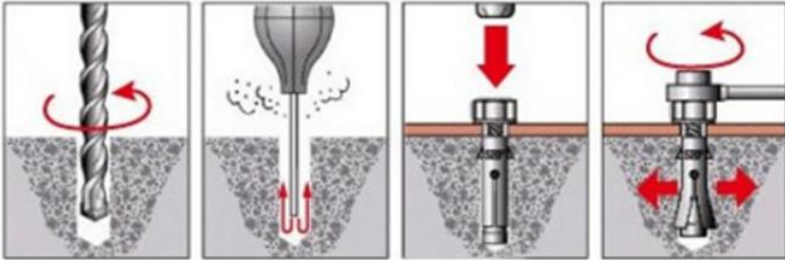

Step5. Remove the bottom connection plate after installation.

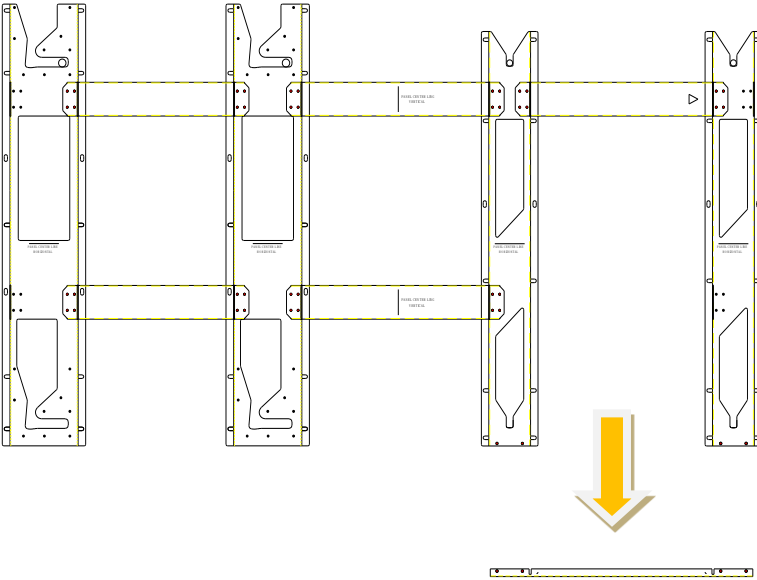

Remove the bottom connection plate to prevent the system box from the panel sticking out and causing interference when hanging the screen.

2) Screen assembly

- First, the 8 PCS fixed screw behind the box are assembled to the box and locked with tools.
- The following figure is marked in red.

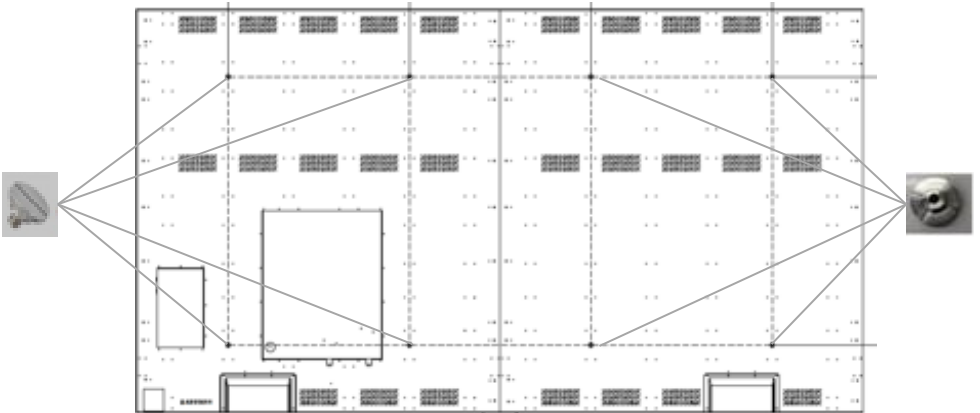

Rear view

Screen Installation

1. The two members jointly lifted the right half cabinet and placed it on the Stand's bracket.

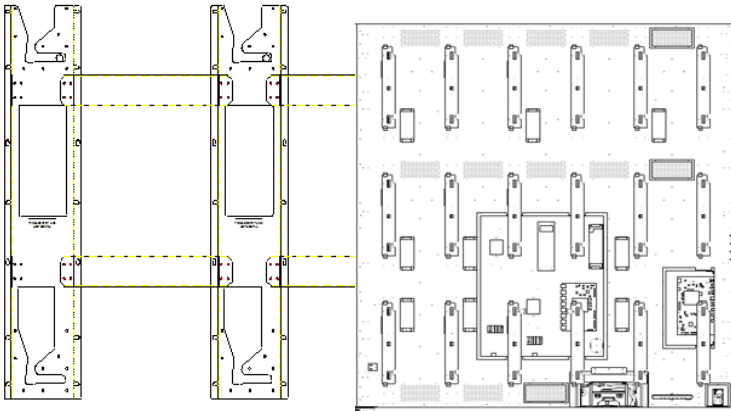

2. Place the left half cabinet on the bracket in order.

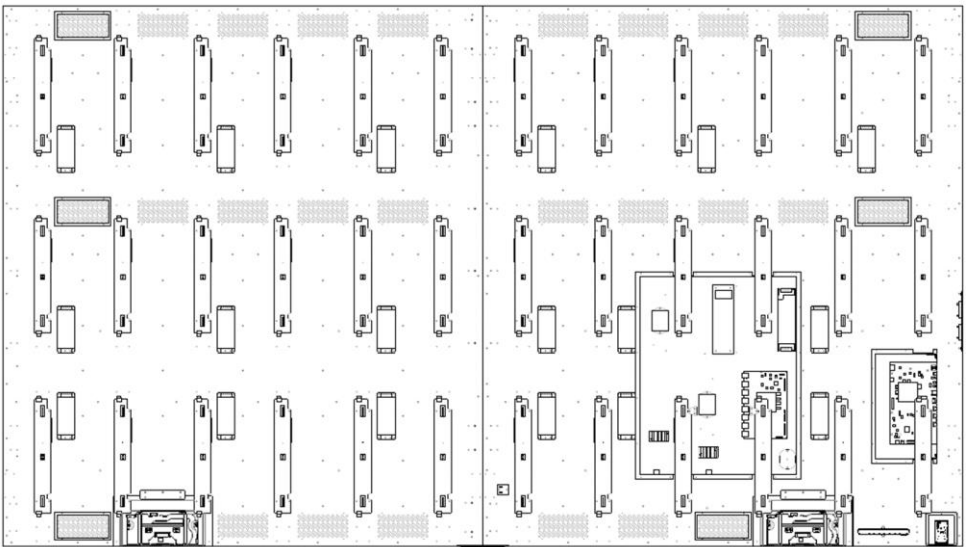

3. You need to connect all the cables and install back all the LDMs.

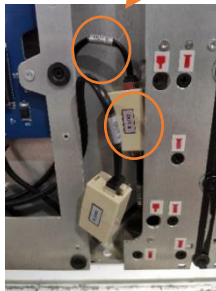
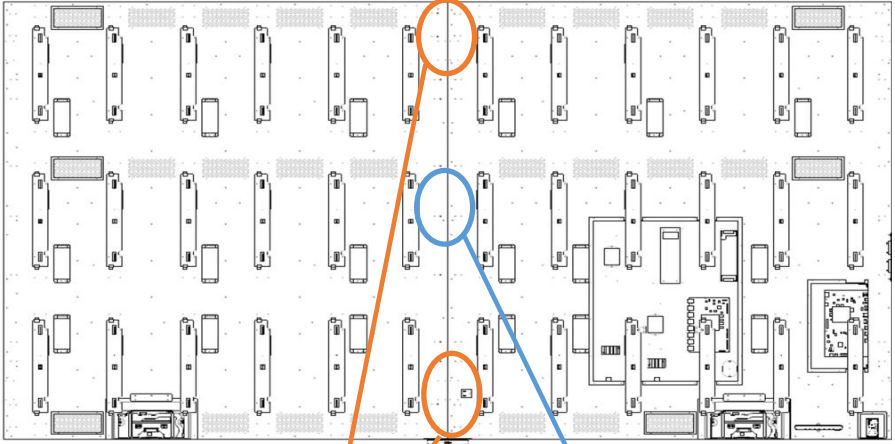

NETWORK CABLE(4PCS)
Please pay attention to the labels, eg. RJ45 cable labelled OUT1 is matched to the connector labelled OUT1.



AC CABLE(1PC)

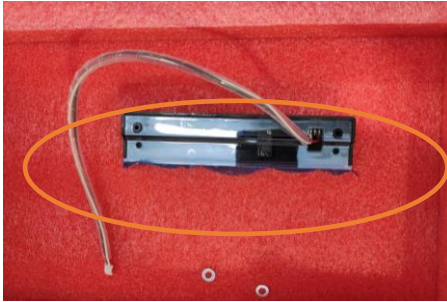

IR cable connector

4. The cabinet is combined by sliding on the wall mount, we must make sure that the steel block is properly connected to the positioning.

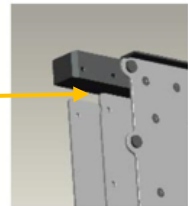
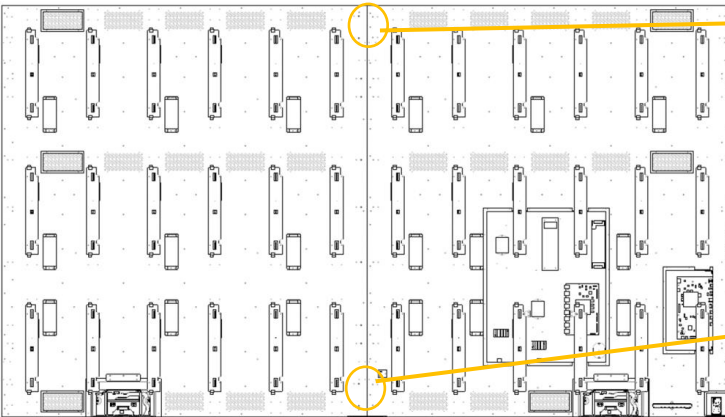

• Top side steel block

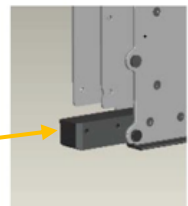

• Bottom side steel block

5. After the cabinet is joined, follow the instructions of Label to quickly fix the cabinet with the hexagonal plate.

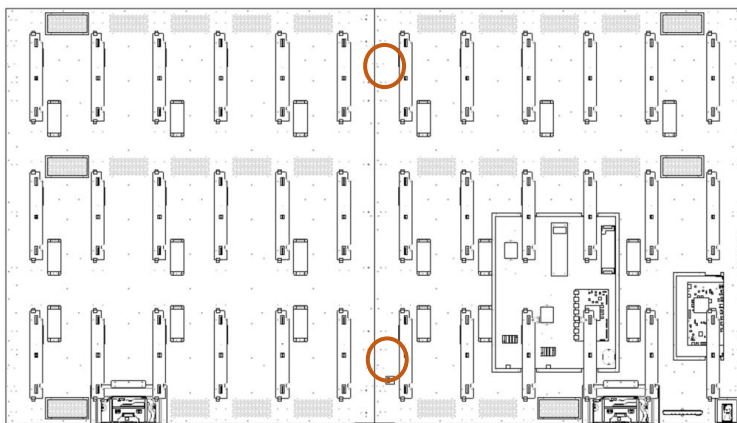

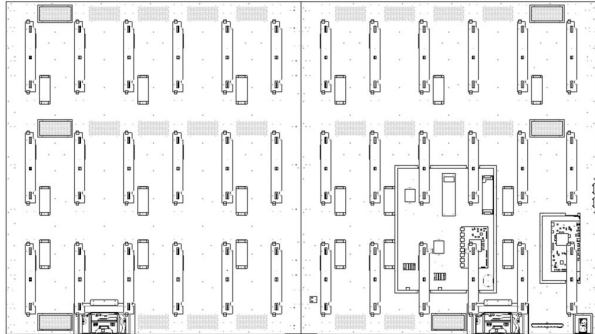

6. Install and tighten 8 pcs black M4 flat head screws to both top and bottom side of the case.

4 PCS M4 screws



before install screws



install back screws

4 PCS M4 screws

7. Install M4 screws.

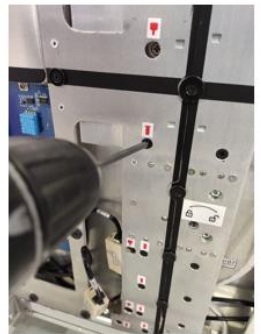

Install 11 pcs fasten screws.

Install 16 pcs M4 flat head screws.

8. The Sensor Box Module has a cable connector to connect the mainboard and the "IR sensor board" of the Sensor Box Module. After the cables are properly connected, the Sensor Box Module is locked with 2 pcs M3 screws below the middle of cabinet. These two screws marked in red must be installed with a screwdriver and cannot be omitted.

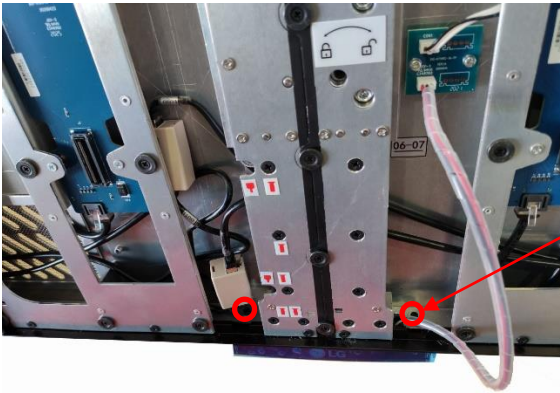

Install Sensor box module location.



9. All the LMDs (LED Panel) have labels stuck on the back side. Please follow below number to install back the LDMs.

<u>01-01</u>	<u>01-02</u>	<u>01-03</u>	<u>01-04</u>	<u>01-05</u>	<u>01-06</u>	<u>01-07</u>	<u>01-08</u>	<u>01-09</u>	<u>01-10</u>	<u>01-11</u>	<u>01-12</u>
<u>02-01</u>	<u>02-02</u>	<u>02-03</u>	<u>02-04</u>	<u>02-05</u>	<u>02-06</u>	<u>02-07</u>	<u>02-08</u>	<u>02-09</u>	<u>02-10</u>	<u>02-11</u>	<u>02-12</u>
<u>03-01</u>	<u>03-02</u>	<u>03-03</u>	<u>03-04</u>	<u>03-05</u>	<u>03-06</u>	<u>03-07</u>	<u>03-08</u>	<u>03-09</u>	<u>03-10</u>	<u>03-11</u>	<u>03-12</u>
<u>04-01</u>	<u>04-02</u>	<u>04-03</u>	<u>04-04</u>	<u>04-05</u>	<u>04-06</u>	<u>04-07</u>	<u>04-08</u>	<u>04-09</u>	<u>04-10</u>	<u>04-11</u>	<u>04-12</u>
<u>05-01</u>	<u>05-02</u>	<u>05-03</u>	<u>05-04</u>	<u>05-05</u>	<u>05-06</u>	<u>05-07</u>	<u>05-08</u>	<u>05-09</u>	<u>05-10</u>	<u>05-11</u>	<u>05-12</u>
<u>06-01</u>	<u>06-02</u>	<u>06-03</u>	<u>06-04</u>	<u>06-05</u>	<u>06-06</u>	<u>06-07</u>	<u>06-08</u>	<u>06-09</u>	<u>06-10</u>	<u>06-11</u>	<u>06-12</u>

Front view

Dismount LDM

Step1. Power off the LED display.

Step2. Hold the 2pcs handles, push the lock inward and pull the handles toward outside, and then take it up.

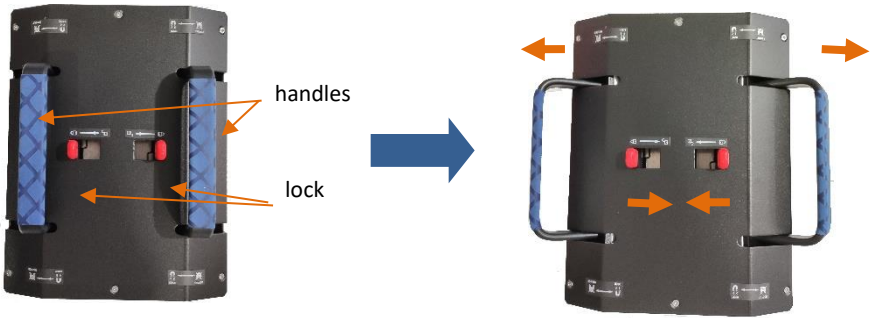

Step3. Take the tool up and horizontally fit it closely to the display surface. Please pay more attention to the direction.



Step4. Pull the handles towards the center.



Step5. Ensure the magnet is locked. Take down the LDM carefully.

Step6. Put down the LDM and tool together carefully onto an anti-static soft pad (such as white foam which used to protect the parts in the flight case, please refer to page 15, item 3).

Step7. Push the lock toward inside and pull the handles toward outside and lift the tool up carefully.

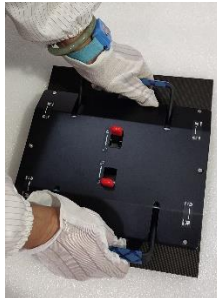
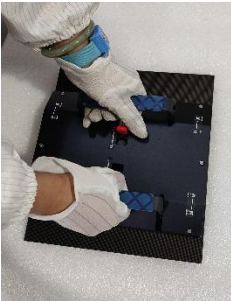

Mount LDM

Step1. Take out a spare LDM and locate the LDM to case, please pay attention to the arrow direction on the back side of it.

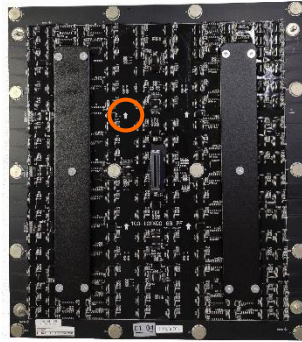
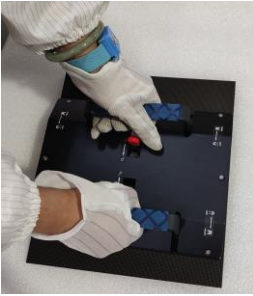

Step2.Flatten the LDM.



Note: When mounting an LDM back, pay more attention to the guide pin which is located in corners to mount it smoothly.

10. We recommend that all the LDMs are installed to the corresponding position on case, or the screen will show color difference. Also, there is a panel serial number at the left bottom of case which match to the one on the back side of LDMs and spare LDMs.

Electrical

The power distribution system used must provide adequate protection against excess line current and leakage currents to earth.

Electrical Characteristics for ONE LAEC015-GN							
At 100V AC Input				At 240V AC Input			
Parameter	Unit	Rating		Parameter	Unit	Rating	
		Normal	Max			Normal	Max
Input current	A	8	20	Input current	A	3.33	8.33
Input freq.	Hz	50 – 60	65	Input freq.	Hz	50 – 60	65
Power	W	800	2000	Power	W	800	2000

Circuit Protection

Each section of the screen should be protected by a Circuit Breaker to protect against high fault currents, and a Residual Current Device (RCD) to detect earth leakage currents.

Earth Leakage Considerations

Each panel of the system has earth leakage current contributions from nineteen switched-mode power supplies and two EMI filters. The total earth leakage current per panel can be up to 14.1mA at 240V. If a 30mA RCD is used, then the maximum number of panels per section should be safely limited to 2.

Inrush-current and Over-current Considerations

The inrush current of the switched mode power supplies used to provide LED and logic power to each panel is specified by the manufacturer as 1160A at 230volts when cold start. However, maximum current in the steady-state for a panel is considerably less: 8.4A at 240 volts and 20A at 100 volts. The circuit breaker used to control a section of the screen must be able to handle the short-term inrush current at switch-on, without causing unnecessary disconnection of the supply, and be able to detect excess currents due to faults within the equipment, during normal operation.

Earthing

Each panel is separately connected to the AC power distribution system's earth through the appliance coupler. All exposed panel metalwork (main frame) is also connected to this earth.

If the framework is earthed only through each panel (i.e. through the panel's mounting bolts), there is a possibility of electrical damage if a wiring fault occurs, or if an electrical discharge, such as lightning strike, hits the panels. Under these circumstances, the current discharge path will be through the panel to earth rather than through the framework to earth. When permanently installed on a metal framework, the framework itself should be directly connected to earth also.

CE-EMC Statement

This product has been certificated by CE. Installations should be located at least 30 meters from other sensitive systems or installations and if situated in close proximity to a roadway it may create interference to vehicle radio communications.

FCC Statement

This equipment has been tested and found to comply with the limits for a Class A digital device, pursuant to Part 15 of the FCC Rules. These limits are designed to provide reasonable protection against harmful interference when the equipment is operated in a commercial environment. This equipment generates, uses, and can radiate radio frequency energy and, if not installed and used in accordance with the instruction manual, may cause harmful interference to radio communications. Operation of this equipment in a residential area is likely to cause harmful interference in which case the user will be required to correct the interference at his own expense.

*Note: Modifications not authorized by the manufacturer may void users authority to operate this device.

Power Cable Wiring

AC Power

An approved three-pole appliance coupler inside the panel connects to the AC supply. The AC power cable is then connected to the EMI filter and distributes to the power supply units. Each panel has an earth point for grounding.

Color of Wire	A.C. Supply connection (for 100V)	A.C. Supply connection (for 240V)
Brown	AC. Live	AC. Live
Blue	AC. Neutral	AC. Neutral
Green/Yellow	AC. Protective earth	AC. Protective earth

Number of power cords

1. Countries using 110V AC : The product contains two input power supply cords intended for connection with two independent AC power source.

2. Countries using 220V AC : The product contains one input power supply cord intended for connection with one independent AC power source.

DC Power

DC power from each power supply unit provides low voltage power to the assigned electronics components, for example, driver board, and fans, the responding color of the wire represents the relevant component's power connection, please note the list below for a clear cabling configuration.

Colour of wire	D.C. Supply connection
White	Green LED / Blue LED / Red LED /TTL
Black	GND

MAKING CONNECTIONS

You can connect various external devices to your monitor. Change the input mode and select the external device you want to connect. For more information about external device connections, see the user manual provided with each device.

Connecting to a PC

Some of the cables are not provided. This monitor supports the Plug and Play* feature.

* Plug and Play: a feature that enables a PC to recognize devices attached by the user without device configuration or user intervention when powering up.

External Device Connection

Some of the cables are not provided. Connect a HD receiver, DVD, or VCR player to the monitor and select an appropriate input mode.

For the best picture and sound quality, connecting external devices to your monitor using HDMI cables is recommended.

! NOTE

- For the best image quality, using the monitor with HDMI connection is recommended.
- To comply with the specifications of the product, use a shielded interface cable with ferrite core, such as a HDMI cable.
- If you turn the monitor on when the set is cold, the screen may flicker. This is normal.
- Sometimes red, green, or blue spots may appear on the screen. This is normal.
- Use a High-Speed HDMI^{®/TM} cable (shorter than 3 meters).
- Use a certified cable with the HDMI logo attached. If you do not use a certified HDMI cable, the screen may not display or a connection error may occur.
- Recommended HDMI Cable Types
 - High Speed HDMI^{®/TM} Cable
 - High Speed HDMI^{®/TM} Cable with Ethernet
- If you cannot hear any sound in HDMI mode, please check your PC settings. Some PCs require you to manually change the default audio output to HDMI.
- If you want to use HDMI-PC mode, you must set your PC/DTV to PC mode.
- You may experience compatibility issues if you use HDMI-PC mode.
- Make sure the power cable is disconnected.
- If you connect a gaming device to the monitor, use the cable provided with the gaming device.
- High Speed HDMI^{®/TM} cables transmit a HD signal up to 1080p and higher.
- When connecting an external audio device, use a device with audio amplifier.

⚠ CAUTION

- Do not press the screen with your finger for a prolonged period as this may result in temporary distortion on the screen.
- Avoid displaying static images on the screen for a long period of time to prevent image retention. Use a screensaver if possible.
- A wireless communication device near your monitor can affect the image.

Using the Input List

↑ (HOME) → 

HDMI1 → HDMI2 → HDMI3 → DISPLAYPORT

Connecting cables

Connect the RS-232C cable as shown in the picture.

The RS-232C protocol is used for communication between the PC and product. You can turn the product on/off, select an input source and adjust the OSD menu from your PC.

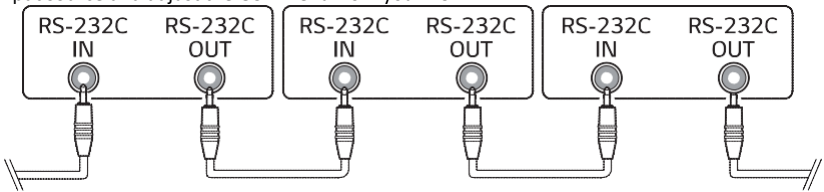

TROUBLESHOOTING

No image is displayed.

- Is the power cord connected to the product?
 - Check if the power cord is correctly plugged into the power outlet.
- Did you install the driver?
 - Check if the Plug and Play function is supported by referring to the graphics card user manual.

Issues Related to Screen

- Is the screen position wrong?
 - Check if the graphics card resolution and frequency are supported by the product. If the frequency is out of range, set to the recommended resolution in the "Display" settings in Control Panel.
- The screen is displayed abnormally.
 - The proper input source is not connected to the port. Connect a cable that matches the input source signal.

Issues Related to Screen (Color)

- After-image appears when the product is turned off.
 - If you display a still image on the screen for a long time, the LED package may be damaged rapidly. Use the screen-saver function.
 - When a dark image is displayed on the screen after an image with high contrast (black and white or grey), this may cause image sticking. This is normal for LED products.
- Screen has poor color resolution (16 colors).
 - Set the color depth to more than 24 bits (true color).
- Screen color is unstable or mono-colored.
 - Check the connection status of the signal cable. Or, re-insert the PC graphics card.

Other

- The power suddenly turned off.
 - Check if the auto-off function is activated on the settings related time.
 - Power source has not been supplied properly. See if the product power cord is connected properly.

Network connection problems

- If the main network line to the last abnormal module is not bright, the main network line is connected abnormally, and the abnormal module outputs an abnormal network line.

Inspection: Recheck the state of the network cable in the corresponding position to confirm that the connection is OK.



- If the abnormal module to the backup network port cable is not bright, the abnormal module input abnormal, and backup network cable connection abnormal.

Inspection: Recheck the state of the network cable in the corresponding position to confirm that the connection is OK.



LDM problems

- The abnormal module position of LDM is abnormal.
Inspection: Replace the LDM in the corresponding position.



- You can replace it with the following procedure.
 1. Power off the panel and unplug the power cable;
 2. Locate the problem LDM;
 3. Dismount the problem LDM from the panel; (Refer to page 36 and 37)
 4. Mount the LDM back to the same position as the problem one; (Refer to page 38)
 5. Make sure the LDM is firmly mounted;
 6. Power on the panel;
 7. Please make sure the replaced LDM is functioning well.

PSU problems

- The abnormal module position of LDM is not bright, the state of the PSU in the corresponding position is power supply abnormally.
Inspection: Replace the PSU in the corresponding position.



The adapter board problems

- The abnormal module position of LDM is not bright, the state of the adapter board in the corresponding position is work abnormally.

Inspection: Replace the adapter board in the corresponding position.

***The receiver board problems***

- The abnormal module position of DMM is not bright, the state of the receiver board in the corresponding position is work abnormally.

Inspection: Replace the receiver board in the corresponding position. And resends the receiver card parameter to all receiver cards or sends to the specified receiver card.



The calibration data is abnormal

- Some LDMs are particularly bright when the screen is white, unlike others.

Inspection: Switch calibration off again, then switch to calibration on to confirm the existence of calibration data.

You can also switch LDMs data and receiver card data to confirm that the calibration data exists and is correct.

If none of the above is feasible, the corresponding calibration data needs to be reloaded and resend.

***The whole screen doesn't light up***

- It may be caused by abnormal power supply and internal power board.

Inspection: Check to make sure the power supply and the power board are in order.

If the signal source is switched without a black screen, confirm that the input source is normal, the signal line is normal, and the signal transfer board is working normally.

PRODUCT SPECIFICATIONS

The product specifications below may be changed without prior notice due to upgrade of product functions.

“ ~ ” refers to alternating current (AC), and “ — ” refers to direct current (DC).

Pixel pitch (distance between pixels)		1.5625 mm
Min. Brightness (After Calibration)		500 nit
Visual Viewing Angle (Horizontal/Vertical)		160 / 160
Refresh Rate (Hz)		≥2880
Resolution		1920 x 1080 - LDM Resolution: 160 x 180
Video signal	Maximum resolution	3840 x 2160 @ 30 Hz - This may not be supported on some OS or graphics card types.
	Recommended resolution	1920 x 1080 @ 60 Hz - This may not be supported on some OS or graphics card types.
	Horizontal frequency	27 kHz to 68 kHz
	Vertical frequency	24 Hz to 60 Hz
	Synchronization	Separate Sync, Digital
Input/ Output ports		HDMI IN, DP IN*, USB 2.0 IN, OPTICAL DIGITAL AUDIO OUT, RS-232C IN/OUT, IR IN, LAN IN
Embedded battery		Applied
Audio	Input Sensitivity	0.7 Vrms
Environmental Conditions	Operating	0 °C to 40 °C
	Operating Humidity	10 % to 90 %
	Storage Temperature	-10 °C to 50 °C
	Storage Humidity	5 % to 90 %
Wi-Fi		Built-In
Sensor		Temperature Sensor
		Current Sensor
Local Key		8 Key Built-In
Power	Rated Voltage	AC 100-240 V ~ 50/60 Hz 20-8.33 A
	Power Consumption	On Mode: 2000 W (Max.) Standby mode (HDMI, DisplayPort): ≤ 0.5 W
Dimensions (Width x Height x Depth) / Weight		3004 mm x 1692 mm x 36.5 mm / 129 kg

* DP Cable: Use a DP cable that is certified to a DP 1.1a (SST) standard or higher.

SW Key Feature

webOS ver.		webOS4.0
Image Customization	Booting Logo	X
	No Signal	O
Office Meeting Mode		O
One:Quick Share		O
Screen Share		O
3rd Party Control Compatibility	Crestron Connected	O
	DPM	O
Power Mgmt.	On/Off Schedule	O
	Holiday Schedule	O
LG ConnectedCare		O
Software Compatibility	SuperSign CMS	O
	LG Assistant	O

SuperSign Software & Manual Downloading from the LG Electronics website.

Visit the LG Electronics *website* <http://partner.lge.com> and download the latest software for your model.

Wireless module(LGSBWAC72) Specifications	
Wireless LAN (IEEE 802.11a/b/g/n/ac)	
Frequency range (MHz)	Output power (Max.) (dBm)
2400 to 2483.5	14
5150 to 5725	16.5
5725 to 5850 (Not for EU)	11.5
Bluetooth	
Frequency range (MHz)	Output power (Max.) (dBm)
2400 to 2483.5	8.5
<ul style="list-style-type: none"> • As band channels can vary per country, the user cannot change or adjust the operating frequency. This product is configured for the regional frequency table. • For consideration of the user, this device should be installed and operated with a minimum distance of 20 cm between the device and the body. • "IEEE 802.11ac" is not available in all countries. 	
(Only Nigeria)	
<div style="border: 1px solid black; padding: 5px; width: fit-content; margin: 0 auto;"> <p><u>Connection and use of this communications equipment is permitted by the Nigerian Communications Commission</u></p> </div>	

(Only HongKong)

Wireless module(LGSBWAC72) Specifications	
Wireless LAN (IEEE 802.11a/b/g/n/ac)	
Frequency range (MHz)	Output power (Max.) (dBm)
2400 to 2483.5	14
5150 to 5350	16.5
5725 to 5850	11.5
Bluetooth	
Frequency range (MHz)	Output power (Max.) (dBm)
2400 to 2483.5	8.5
<ul style="list-style-type: none"> • As band channels can vary per country, the user cannot change or adjust the operating frequency. This product is configured for the regional frequency table. • For consideration of the user, this device should be installed and operated with a minimum distance of 20 cm between the device and the body. 	

HDMI/ DisplayPort (PC) Support mode

Resolution	Horizontal frequency (kHz)	Vertical frequency (Hz)
800 x 600	37.879	60.317
1024 x 768	48.363	60
1280 x 720	44.772	59.855
1366 x 768	47.7	60
1280 x 1024	63.981	60.02
1680 x 1050	65.29	59.954
1920 x 1080	67.5	60
3840 x 2160	67.5	30

HDMI/ DisplayPort (DTV) Support mode

Resolution	Horizontal frequency (kHz)	Vertical frequency (Hz)
480/60p	31.5	60
576/50p	31.25	50
720/50p	37.5	50
720/60p	45	60
1080/50i	28.1	50
1080/60i	33.75	60
1080/50p	56.25	50
1080/60p	67.432	59.94
1080/60p	67.5	60
2160/30p	67.5	30

**NOTE**

- When the cable is connected to the HDMI or the DisplayPort, you can select the PC/DTV mode optionally. It is recommended that you select PC mode when connecting to a PC and select DTV mode when connecting to other devices. The DTV mode refers to all modes excluding the PC mode.
- Vertical frequency: The product display functions by the screen image changing dozens of times every second like a fluorescent lamp. The vertical frequency or refresh rate is the number of image displays per second. The unit is Hz.
- Horizontal frequency: The horizontal interval is the time taken to display one horizontal line. When 1 is divided by the horizontal interval, the number of horizontal lines displayed every second can be tabulated as the horizontal frequency. The unit is kHz.

LICENSES

Supported licenses may differ by model. For more information of the licenses, visit www.lg.com.



The terms HDMI, HDMI High-Definition Multimedia Interface, and the HDMI Logo are trademarks or registered trademarks of HDMI Licensing Administrator, Inc.

Manufactured under license from Dolby Laboratories. Dolby, Dolby Vision, Dolby Audio, Dolby Atmos, and the double-D symbol are trademarks of Dolby Laboratories.

For DTS patents, see <http://patents.dts.com>. Manufactured under license from DTS Licensing Limited. DTS, the Symbol, & DTS and the Symbol together, DTS 2.0 Channel, DTS 2.0+Digital Out, DTS-HD, and DTS Virtual:X are registered trademarks or trademarks of DTS, Inc. in the United States and/or other countries. © DTS, Inc. All Rights Reserved.



The Bluetooth® word mark and logos are registered trademarks owned by Bluetooth SIG, Inc. and any use of such marks by LG Electronics Inc. is under license. Other trademarks and trade names are those of their respective owners.



The model and serial number of the product are located on the back and on one side of the product. Record them below in case you ever need service.

MODEL

SERIAL

NO.

Temporary noise is normal when powering ON or OFF this device.