



Lexmark™

# **B2865, M5255, M5265, M5270, MS725, MS821, MS822, MS823, MS824, MS825, MS826**

---

## **User's Guide**

**June 2018**

**[www.lexmark.com](http://www.lexmark.com)**

---

Machine type(s):

4064

Model(s):

210, 230, 235, 295, 410, 430, 435, 438, 495, 630, 635, 695, 830, and their equivalent models

# Contents

- Safety information..... 6**
  - Conventions..... 6
  - Product statements..... 6
  
- Learning about the printer..... 9**
  - Finding information about the printer.....9
  - Selecting a location for the printer..... 10
  - Printer configurations..... 11
  - Attaching cables..... 13
  
- Using the control panel..... 15**
  - Lexmark B2865, Lexmark MS725, Lexmark MS821, Lexmark MS823, and Lexmark MS825..... 15**
  - Lexmark M5255, Lexmark M5265, Lexmark M5270, Lexmark MS822, Lexmark MS824, and Lexmark MS826..... 16**
  - Understanding the status of the power button and indicator light..... 16
  
- Setting up and using the home screen applications..... 18**
  - Using the home screen.....18
  - Customizing the home screen..... 19
  - Using Display Customization..... 19
  - Configuring Eco-Settings..... 20
  - Creating a Cloud Connector profile..... 20
  - Setting up Device Quotas.....20
  - Using QR Code Generator.....21
  - Using Customer Support.....21
  - Managing bookmarks.....21
  - Managing contacts.....22
  
- Setting up and using the accessibility features..... 25**
  - Activating Voice Guidance.....25
  - Navigating the screen using gestures.....25
  - Enabling Magnification mode..... 26
  - Adjusting the Voice Guidance speech rate.....26
  - Using the keyboard on the display.....26

Enabling spoken passwords or personal identification numbers..... 26

**Loading paper and specialty media..... 27**

Setting the paper size and type.....27

Configuring Universal paper settings.....27

Loading the 250- or 550-sheet tray.....27

Loading the 2100-sheet tray..... 30

Loading the multipurpose feeder.....35

Linking trays.....36

**Paper support.....37**

Supported paper sizes..... 37

Supported paper types.....40

Supported paper weights..... 42

**Printing.....45**

Printing from a computer.....45

Printing from a mobile device..... 45

Printing from a flash drive..... 46

Supported flash drives and file types.....47

Configuring confidential jobs..... 48

Printing confidential and other held jobs..... 48

Printing from a Cloud Connector profile..... 49

Printing a font sample list..... 49

Printing a directory list..... 50

**Understanding the printer menus.....51**

Menu map.....51

Device..... 52

Print..... 63

Paper.....71

USB Drive..... 72

Network/Ports.....74

Security..... 86

Reports..... 93

Help.....94

Troubleshooting.....94

Printing the Menu Settings Page.....94

**Securing the printer..... 95**

Locating the security slot..... 95  
Erasing printer memory..... 95  
Erasing printer hard disk memory.....95  
Encrypting the printer hard disk..... 96  
Restoring factory default settings..... 96  
Statement of Volatility..... 96

**Maintaining the printer..... 98**

Adjusting the speaker volume..... 98  
Networking.....98  
Cleaning the printer..... 100  
Ordering parts and supplies..... 101  
Replacing parts and supplies..... 105  
Moving the printer..... 123  
Saving energy and paper..... 124  
Recycling..... 125

**Clearing jams..... 126**

Avoiding jams..... 126  
Identifying jam locations..... 128  
Paper jam in trays..... 130  
Paper jam in door A.....130  
Paper jam in door C..... 133  
Paper jam in the standard bin.....134  
Paper jam in the multipurpose feeder..... 135  
Paper jam in the output expander..... 136  
Paper jam in the high-capacity output expander..... 136  
Paper jam in the 4-bin mailbox..... 137  
Paper jam in the staple finisher..... 138  
Paper jam in the staple, hole punch finisher..... 139  
Staple jam in the staple finisher..... 140  
Staple jam in the staple, hole punch finisher..... 143



<b>Troubleshooting.....</b>	<b>146</b>
Network connection problems.....	146
Hardware options problems.....	148
Issues with supplies.....	149
Paper feed problems.....	151
Printing problems.....	154
Contacting customer support.....	185
<b>Upgrading and migrating.....</b>	<b>187</b>
Hardware.....	187
Software.....	207
Firmware.....	208
<b>Notices.....</b>	<b>210</b>
<b>Index.....</b>	<b>222</b>

# Safety information







## Conventions

**Note:** A *note* identifies information that could help you.







**Warning:** A *warning* identifies something that could damage the product hardware or software.

**CAUTION:** A *caution* indicates a potentially hazardous situation that could injure you.

Different types of caution statements include:

-  **CAUTION—POTENTIAL INJURY:** Indicates a risk of injury.
-  **CAUTION—SHOCK HAZARD:** Indicates a risk of electrical shock.
-  **CAUTION—HOT SURFACE:** Indicates a risk of burn if touched.
-  **CAUTION—TIPPING HAZARD:** Indicates a crush hazard.
-  **CAUTION—PINCH HAZARD:** Indicates a risk of being caught between moving parts.
-  **CAUTION—ROTATING FAN BLADES:** Indicates a risk of laceration from moving fan blades.

## Product statements

-  **CAUTION—POTENTIAL INJURY:** To avoid the risk of fire or electrical shock, connect the power cord to an appropriately rated and properly grounded electrical outlet that is near the product and easily accessible.
-  **CAUTION—POTENTIAL INJURY:** To avoid the risk of fire or electrical shock, use only the power cord provided with this product or the manufacturer's authorized replacement.
-  **CAUTION—POTENTIAL INJURY:** Do not use this product with extension cords, multioutlet power strips, multioutlet extenders, or UPS devices. The power capacity of these types of accessories can be easily overloaded by a laser printer and may result in a risk of fire, property damage, or poor printer performance.
-  **CAUTION—POTENTIAL INJURY:** Only a Lexmark Inline Surge Protector that is properly connected between the printer and the power cord provided with the printer may be used with this product. The use of non-Lexmark surge protection devices may result in a risk of fire, property damage, or poor printer performance.
-  **CAUTION—SHOCK HAZARD:** To avoid the risk of electrical shock, do not place or use this product near water or wet locations.
-  **CAUTION—SHOCK HAZARD:** To avoid the risk of electrical shock, do not set up this product or make any electrical or cabling connections, such as the power cord, fax feature, or telephone, during a lightning storm.

 **CAUTION—POTENTIAL INJURY:** Do not cut, twist, bind, crush, or place heavy objects on the power cord. Do not subject the power cord to abrasion or stress. Do not pinch the power cord between objects such as furniture and walls. If any of these things happen, a risk of fire or electrical shock results. Inspect the power cord regularly for signs of such problems. Remove the power cord from the electrical outlet before inspecting it.

 **CAUTION—SHOCK HAZARD:** To avoid the risk of electrical shock, make sure that all external connections (such as Ethernet and telephone system connections) are properly installed in their marked plug-in ports.

 **CAUTION—SHOCK HAZARD:** To avoid the risk of electrical shock, if you are accessing the controller board or installing optional hardware or memory devices sometime after setting up the printer, then turn the printer off, and unplug the power cord from the electrical outlet before continuing. If you have any other devices attached to the printer, then turn them off as well, and unplug any cables going into the printer.

 **CAUTION—SHOCK HAZARD:** To avoid the risk of electrical shock when cleaning the exterior of the printer, unplug the power cord from the electrical outlet and disconnect all cables from the printer before proceeding.





 **CAUTION—POTENTIAL INJURY:** If the printer weight is greater than 18 kg (40 lb), then it requires two or more trained personnel to lift it safely.

 **CAUTION—POTENTIAL INJURY:** When moving the printer, follow these guidelines to avoid personal injury or printer damage:

- Make sure that all doors and trays are closed.
- Turn off the printer, and then unplug the power cord from the electrical outlet.
- Disconnect all cords and cables from the printer.
- If the printer has separate floor-standing optional trays or output options attached to it, then disconnect them before moving the printer.
- If the printer has a caster base, then carefully roll it to the new location. Use caution when passing over thresholds and breaks in flooring.
- If the printer does not have a caster base but is configured with optional trays or output options, then remove the output options and lift the printer off the trays. Do not try to lift the printer and any options at the same time.
- Always use the handholds on the printer to lift it.
- Any cart used to move the printer must have a surface able to support the full footprint of the printer.
- Any cart used to move the hardware options must have a surface able to support the dimensions of the options.
- Keep the printer in an upright position.
- Avoid severe jarring movements.
- Make sure that your fingers are not under the printer when you set it down.
- Make sure that there is adequate clearance around the printer.

 **CAUTION—TIPPING HAZARD:** Installing one or more options on your printer or MFP may require a caster base, furniture, or other feature to prevent instability causing possible injury. For more information on supported configurations, see [www.lexmark.com/multifunctionprinters](http://www.lexmark.com/multifunctionprinters).

 **CAUTION—TIPPING HAZARD:** To reduce the risk of equipment instability, load each tray separately. Keep all other trays closed until needed.

-  **CAUTION—HOT SURFACE:** The inside of the printer might be hot. To reduce the risk of injury from a hot component, allow the surface to cool before touching it.
-  **CAUTION—PINCH HAZARD:** To avoid the risk of a pinch injury, use caution in areas marked with this label. Pinch injuries may occur around moving parts, such as gears, doors, trays, and covers.
-  **CAUTION—ROTATING FAN BLADES:** To avoid the risk of laceration from moving fan blades, turn off the printer and unplug the power cord from the electrical outlet before accessing areas marked with this symbol.
-  **CAUTION—POTENTIAL INJURY:** This product uses a laser. Use of controls or adjustments or performance of procedures other than those specified in the *User's Guide* may result in hazardous radiation exposure.
-  **CAUTION—POTENTIAL INJURY:** The lithium battery in this product is not intended to be replaced. There is a danger of explosion if a lithium battery is incorrectly replaced. Do not recharge, disassemble, or incinerate a lithium battery. Discard used lithium batteries according to the manufacturer's instructions and local regulations.

This product is designed, tested, and approved to meet strict global safety standards with the use of specific manufacturer's components. The safety features of some parts may not always be obvious. The manufacturer is not responsible for the use of other replacement parts.

Refer service or repairs, other than those described in the user documentation, to a service representative.

This product uses a printing process that heats the print media, and the heat may cause the media to release emissions. You must understand the section in your operating instructions that discusses the guidelines for selecting print media to avoid the possibility of harmful emissions.

This product may produce small amounts of ozone during normal operation, and may be equipped with a filter designed to limit ozone concentrations to levels well below the recommended exposure limits. To avoid high ozone concentration levels during extensive usage, install this product in a well-ventilated area and replace the ozone and exhaust filters if instructed to do so in the product maintenance instructions. If there are no references to filters in the product maintenance instructions, then there are no filters requiring replacement for this product.

**SAVE THESE INSTRUCTIONS.**

# Learning about the printer

## Finding information about the printer

What are you looking for?	Find it here
Initial setup instructions: <ul style="list-style-type: none"> <li>• Connecting the printer</li> <li>• Installing the printer software</li> </ul>	See the setup documentation that came with the printer or go to <a href="http://support.lexmark.com">http://support.lexmark.com</a> .
More setup and instructions for using the printer: <ul style="list-style-type: none"> <li>• Selecting and storing paper and specialty media</li> <li>• Loading paper</li> <li>• Configuring printer settings</li> <li>• Viewing and printing documents and photos</li> <li>• Setting up and using the printer software</li> <li>• Configuring the printer on a network</li> <li>• Caring for and maintaining the printer</li> <li>• Troubleshooting and solving problems</li> </ul>	<i>Information Center</i> —Go to <a href="http://infoserve.lexmark.com">http://infoserve.lexmark.com</a> . <i>Help Menu Pages</i> —Access the guides on the printer firmware or go to <a href="http://support.lexmark.com">http://support.lexmark.com</a> . <i>Touch Screen Guide</i> —Go to <a href="http://support.lexmark.com">http://support.lexmark.com</a> . Product videos—Go to <a href="http://infoserve.lexmark.com/idv/">http://infoserve.lexmark.com/idv/</a> .
Information on setting up and configuring the accessibility features of your printer	<i>Lexmark Accessibility Guide</i> —Go to <a href="http://support.lexmark.com">http://support.lexmark.com</a> .
Help using the printer software	Help for Microsoft® Windows® or Macintosh operating systems—Open a printer software program or application, and then click <b>Help</b> .  Click  to view context-sensitive information.  <b>Notes:</b> <ul style="list-style-type: none"> <li>• Help is automatically installed with the printer software.</li> <li>• Depending on the operating system, the printer software is located in the printer program folder or on the desktop.</li> </ul>

What are you looking for?	Find it here
<p>The latest supplemental information, updates, and customer support:</p> <ul style="list-style-type: none"> <li>• Documentation</li> <li>• Driver downloads</li> <li>• Live chat support</li> <li>• E-mail support</li> <li>• Voice support</li> </ul>	<p>Go to <a href="http://support.lexmark.com">http://support.lexmark.com</a>.</p> <p><b>Note:</b> Select your country or region, and then select your product to view the appropriate support site.</p> <p>Support contact information for your country or region can be found on the website or on the printed warranty that came with the printer.</p> <p>Have the following information ready when you contact customer support:</p> <ul style="list-style-type: none"> <li>• Place and date of purchase</li> <li>• Machine type and serial number</li> </ul> 
<ul style="list-style-type: none"> <li>• Safety information</li> <li>• Regulatory information</li> <li>• Warranty information</li> <li>• Environmental information</li> </ul>	<p>Warranty information varies by country or region:</p> <ul style="list-style-type: none"> <li>• <b>In the U.S.</b>—See the Statement of Limited Warranty included with the printer, or go to <a href="http://support.lexmark.com">http://support.lexmark.com</a>.</li> <li>• <b>In other countries and regions</b>—See the printed warranty that came with the printer.</li> </ul> <p><i>Product Information Guide</i>—See the documentation that came with the printer or go to <a href="http://support.lexmark.com">http://support.lexmark.com</a>.</p>

## Selecting a location for the printer

When selecting a location for the printer, leave enough room to open trays, covers, and doors and to install hardware options.

- Set up the printer near an electrical outlet.

 **CAUTION—POTENTIAL INJURY:** To avoid the risk of fire or electrical shock, connect the power cord to an appropriately rated and properly grounded electrical outlet that is near the product and easily accessible.

 **CAUTION—SHOCK HAZARD:** To avoid the risk of electrical shock, do not place or use this product near water or wet locations.

- Make sure that airflow in the room meets the latest revision of the ASHRAE 62 standard or the CEN Technical Committee 156 standard.
- Provide a flat, sturdy, and stable surface.

- Keep the printer:
  - Clean, dry, and free of dust.
  - Away from stray staples and paper clips.
  - Away from the direct airflow of air conditioners, heaters, or ventilators.
  - Free from direct sunlight and humidity extremes.
- Observe the recommended temperatures and avoid fluctuations:

Ambient temperature	10 to 32.2°C (50 to 90°F)
Storage temperature	-40 to 43.3°C (-40 to 110°F)

- Allow the following recommended amount of space around the printer for proper ventilation:

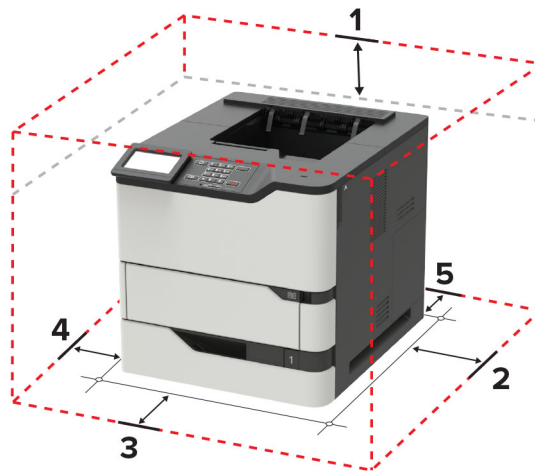

1	Top	152 mm (6 in.)
2	Right side	152 mm (6 in.)
3	Front	406 mm (16 in.) <b>Note:</b> The minimum space needed in front of the printer is 76 mm (3 in.).
4	Left side	152 mm (6 in.)
5	Rear	152 mm (6 in.)

## Printer configurations

**CAUTION—TIPPING HAZARD:** Installing one or more options on your printer or MFP may require a caster base, furniture, or other feature to prevent instability causing possible injury. For more information on supported configurations, see [www.lexmark.com/multifunctionprinters](http://www.lexmark.com/multifunctionprinters).

**CAUTION—TIPPING HAZARD:** To reduce the risk of equipment instability, load each tray separately. Keep all other trays closed until needed.

You can configure your printer by adding optional 250-, 550-, or 2100-sheet trays. For more information, see [“Installing the 250- or 550-sheet tray” on page 196](#) or [“Installing the 2100-sheet tray” on page 197](#).

### Basic model



1	Standard 550-sheet tray
2	Multipurpose feeder
3	Control panel <b>Note:</b> The appearance may vary depending on your printer model.
4	Standard bin

### Fully-configured model





	Hardware option	Alternative hardware option
1	4-bin mailbox	<ul style="list-style-type: none"> <li>• Output expander</li> <li>• High-capacity output</li> <li>• Staple finisher</li> <li>• Staple, hole punch finisher</li> </ul>
2	Optional 2100-sheet tray	None
3	Caster base	None
4	Optional 550-sheet tray	Optional 250-sheet tray
5	Staple, hole punch finisher	<ul style="list-style-type: none"> <li>• Output expander</li> <li>• High-capacity output</li> <li>• 4-bin mailbox</li> <li>• Staple finisher</li> </ul>

The staple, hole punch finisher must not be combined with any other output options.

In a configuration with two or more optional finishers:

- The staple finisher must always be on top.
- The high-capacity output expander must always be at the bottom.
- The output expander is the only option that can be placed on top of the high-capacity output expander.
- The output expander and mailbox may be installed in any order.

When using optional trays:

- Always use a caster base when the printer is configured with a 2100-sheet tray.
- The 2100-sheet tray must always be at the bottom of a configuration.
- A maximum of four optional trays may be configured with the printer.
- The optional 250- and 550-sheet trays may be installed in any order.

## Attaching cables

 **CAUTION—SHOCK HAZARD:** To avoid the risk of electrical shock, do not set up this product or make any electrical or cabling connections, such as the power cord, fax feature, or telephone, during a lightning storm.

 **CAUTION—POTENTIAL INJURY:** To avoid the risk of fire or electrical shock, connect the power cord to an appropriately rated and properly grounded electrical outlet that is near the product and easily accessible.

 **CAUTION—POTENTIAL INJURY:** To avoid the risk of fire or electrical shock, use only the power cord provided with this product or the manufacturer's authorized replacement.

**Warning—Potential Damage:** To avoid loss of data or printer malfunction, do not touch the USB cable, any wireless network adapter, or the printer in the areas shown while actively printing.

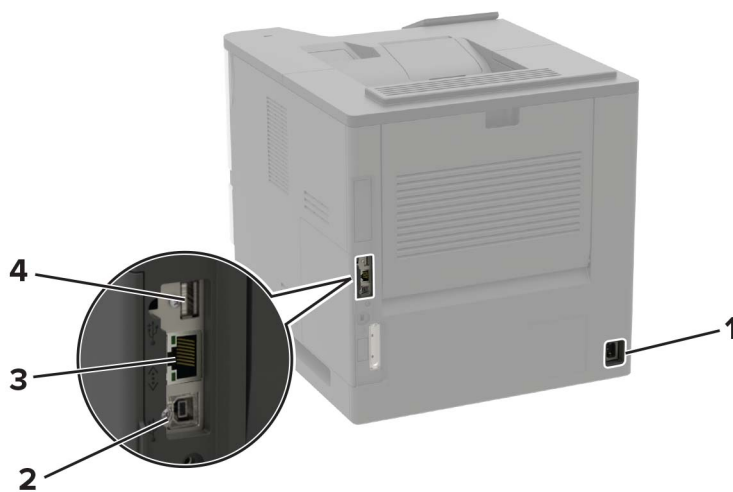

	Use the	To
1	Power cord socket	Connect the printer to an electrical outlet.
2	USB printer port	Connect the printer to a computer.
3	Ethernet port	Connect the printer to a network.
4	USB port	Attach a keyboard or any compatible option.

## Using the control panel

### Lexmark B2865, Lexmark MS725, Lexmark MS821, Lexmark MS823, and Lexmark MS825

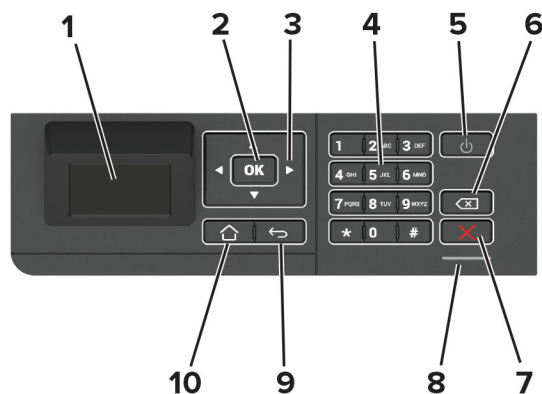

	Use the	To
1	Display	<ul style="list-style-type: none"> <li>View printer messages and supply status.</li> <li>Set up and operate the printer.</li> </ul>
2	Select button	<ul style="list-style-type: none"> <li>Select a menu option.</li> <li>Save the changes in a setting.</li> </ul>
3	Arrow buttons	<ul style="list-style-type: none"> <li>Scroll through menus or move between screens and menu options.</li> <li>Adjust the numeric value of a setting.</li> </ul>
4	Numeric keypad	Enter numbers or symbols in an input field.
5	Power button	Turn on or turn off the printer. <b>Note:</b> To turn off the printer, press and hold the power button for five seconds.
6	Backspace button	Move the cursor backward and delete a character in an input field.
7	Stop or Cancel button	Stop the current printer task.
8	Indicator light	Check the printer status.
9	Back button	Return to the previous screen.
10	Home button	Go to the home screen.

## Lexmark M5255, Lexmark M5265, Lexmark M5270, Lexmark MS822, Lexmark MS824, and Lexmark MS826

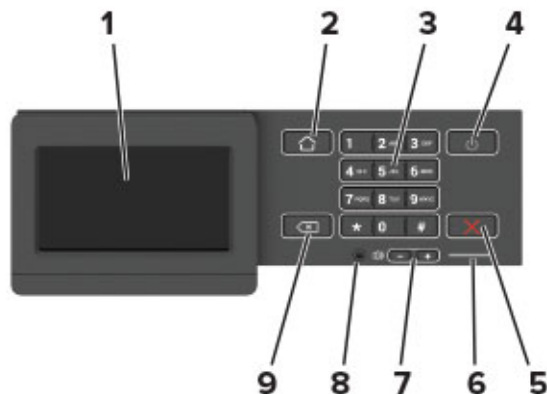

	Use the	To
1	Display	<ul style="list-style-type: none"> <li>View printer messages and supply status.</li> <li>Set up and operate the printer.</li> </ul>
2	Home button	Go to the home screen.
3	Numeric keypad	Enter numbers or symbols in an input field.
4	Power button	Turn on or turn off the printer. <b>Note:</b> To turn off the printer, press and hold the power button for five seconds.
5	Stop or Cancel button	Stop the current printer task.
6	Indicator light	Check the printer status.
7	Volume buttons	Adjust the speaker volume.
8	Headset or speaker port	Attach a headset or speaker. <b>Note:</b> This feature is available only in some printer units.
9	Back button	Return to the previous screen.

## Understanding the status of the power button and indicator light

Indicator light	Printer status
Off	The printer is off or in Hibernate mode.
Blue	The printer is ready or processing data.
Red	The printer requires user intervention.

Power button light	Printer status
Off	The printer is off, ready, or processing data.
Solid amber	The printer is in Sleep mode.

---

Power button light	Printer status
Blinking amber	The printer is in Hibernate mode.

# Setting up and using the home screen applications

**Note:** These applications are supported only in some printer models.

## Using the home screen

**Note:** Your home screen may vary depending on your home screen customization settings, administrative setup, and active embedded solutions.

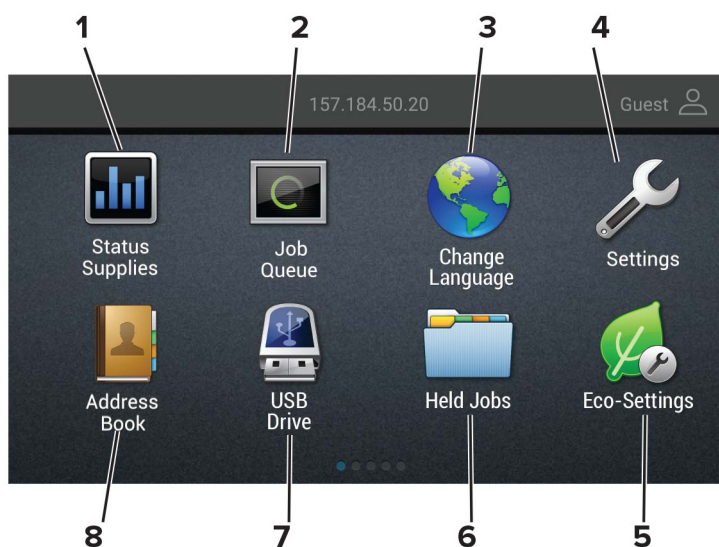

Touch		To
1	Status/Supplies	<ul style="list-style-type: none"> <li>Show a warning or error message whenever the printer requires intervention to continue processing.</li> <li>View more information on the printer warning or message, and on how to clear it.</li> </ul> <p><b>Note:</b> You can also access this setting by touching the top section of the home screen.</p>
2	Job Queue	<p>Show all the current print jobs.</p> <p><b>Note:</b> You can also access this setting by touching the top section of the home screen.</p>
3	Change Language	Change the language on the display.
4	Settings	Access the printer menus.
5	Eco-Settings	Manage energy consumption, noise, toner, and paper usage settings.
6	Held Jobs	Show the print jobs that are held in the printer memory.
7	USB Drive	Print photos and documents from a flash drive.
8	Address Book	Manage a contact list that other applications on the printer can access.

## Customizing the home screen

- 1 Open a web browser, and then type the printer IP address in the address field.

### Notes:

- View the printer IP address on the printer home screen. The IP address appears as four sets of numbers separated by periods, such as 123.123.123.123.
- If you are using a proxy server, then temporarily disable it to load the web page correctly.

- 2 Click **Settings** > **Device** > **Visible Home Screen Icons**.
- 3 Select the icons that you want to appear on the home screen.
- 4 Apply the changes.

## Using Display Customization

Before using the application, make sure to do the following:

- From the Embedded Web Server, click **Apps** > **Display Customization** > **Configure**.
- Enable and configure the screen saver, slideshow, and wallpaper settings.

### Managing screen saver and slide show images

- 1 From the Screen Saver and Slideshow Images section, add, edit, or delete an image.

### Notes:

- You can add up to 10 images.
- When enabled, the status icons appear on the screen saver only when there are errors, warnings, or cloud-based notifications.

- 2 Apply the changes.

### Changing the wallpaper image

- 1 From the home screen, touch **Change Wallpaper**.
- 2 Select an image to use.
- 3 Apply the changes.

### Running a slide show from a flash drive

- 1 Insert a flash drive into the USB port.
- 2 From the home screen, touch **Slideshow**.  
Images appear in alphabetical order.

**Note:** You can remove the flash drive after the slide show starts, but the images are not stored in the printer. If the slide show stops, then insert the flash drive again to view the images.

## Configuring Eco-Settings

- 1 From the home screen, touch **Eco-Settings**.
- 2 Configure Eco-Mode or Schedule Power Modes.
- 3 Apply the changes.

## Creating a Cloud Connector profile

We recommend logging in to the printer before you create a profile. To enable a login method, see the *Embedded Web Server - Security Admin Guide*.

- 1 From the home screen, touch **Cloud Connector**.
- 2 Select a cloud service provider.
- 3 Touch **Create a Profile** or .
- 4 Type a unique profile name.
- 5 If necessary, enter a PIN.  
**Note:** When using the printer as guest, protect the profile with a PIN.
- 6 Touch **Create**, and then take note of the authorization code.  
**Note:** The authorization code is valid only for 24 hours.
- 7 Open a web browser, and then go to <https://lexmark.cloud-connect.co>.
- 8 Click **Next**, and then accept the Terms of Use.
- 9 Enter the authorization code, and then click **Connect**.
- 10 Log in to your cloud service provider account.
- 11 Grant permissions.

**Note:** To complete the authorization process, open the profile within 72 hours.

## Setting up Device Quotas

You may need administrative rights to access the application.

- 1 Open a Web browser, and then type the printer IP address in the address field.

**Notes:**

- View the printer IP address on the printer home screen. The IP address appears as four sets of numbers separated by periods, such as 123.123.123.123.
- If you are using a proxy server, then temporarily disable it to load the Web page correctly.

- 2 Click **Apps > Device Quotas > Configure**.
- 3 From the User Accounts section, add or edit a user, and then set the user quota.
- 4 Apply the changes.



**Note:** For information on how to configure the application and its security settings, see the *Device Quotas Administrator's Guide*.

## Using QR Code Generator

You may need administrative rights to access the application.

- 1 Open a Web browser, and then type the printer IP address in the address field.

**Notes:**

- View the printer IP address on the printer home screen. The IP address appears as four sets of numbers separated by periods, such as 123.123.123.123.
- If you are using a proxy server, then temporarily disable it to load the Web page correctly.

- 2 Click **Apps > QR Code Generator > Configure**.

- 3 Do either of the following:

- Select a default QR code value.
- Type a QR code value.

- 4 Apply the changes.

## Using Customer Support

- 1 From the home screen, touch **Customer Support**.

- 2 Print or e-mail the information.

**Note:** For information on configuring the application settings, see the *Customer Support Administrator's Guide*.

## Managing bookmarks

### Creating bookmarks

Use bookmarks to print frequently accessed documents that are stored in servers or on the web.

- 1 Open a web browser, and then type the printer IP address in the address field.

**Notes:**

- View the printer IP address on the printer home screen. The IP address appears as four sets of numbers separated by periods, such as 123.123.123.123.
- If you are using a proxy server, then temporarily disable it to load the web page correctly.

- 2 Click **Bookmark Setup > Add Bookmark**, and then type a unique name for the bookmark.

**3** Select an Address protocol type, and then do one of the following:

- For HTTP and HTTPS, type the URL that you want to bookmark.
- For HTTPS, make sure to use the host name instead of the IP address. For example, type **myWebsite.com/sample.pdf** instead of typing **123.123.123.123/sample.pdf**. Make sure that the host name also matches the Common Name (CN) value in the server certificate. For more information on obtaining the CN value in the server certificate, see the help information for your web browser.
- For FTP, type the FTP address. For example, **myServer/myDirectory**. Enter the FTP port. Port 21 is the default port for sending commands.
- For SMB, type the network folder address. For example, **myServer/myShare/myFile.pdf**. Type the network domain name.
- If necessary, select the Authentication type for FTP and SMB.

To limit access to the bookmark, enter a PIN.

**Note:** The application supports the following file types: PDF, JPEG, TIFF, and HTML-based web pages. Other file types such as DOCX and XLXS are supported in some printer models.

**4** Click **Save**.

**Note:** To manage bookmarks, click **Bookmark Setup**.

## Creating folders

**1** Open a web browser, and then type the printer IP address in the address field.

**Notes:**

- View the printer IP address on the printer home screen. The IP address appears as four sets of numbers separated by periods, such as 123.123.123.123.
- If you are using a proxy server, then temporarily disable it to load the web page correctly.

**2** Click **Bookmark Setup > Add Folder**, and then type a unique name for the folder.

**Note:** To limit access to the folder, enter a PIN.

**3** Click **Save**.

**Notes:**

- You can create folders or bookmarks inside a folder. To create a bookmark, see [“Creating bookmarks” on page 21](#).
- To manage folders, click **Bookmark Setup**.

## Managing contacts

### Adding contacts

**1** Open a web browser, and then type the printer IP address in the address field.

**Notes:**

- View the printer IP address on the printer home screen. The IP address appears as four sets of numbers separated by periods, such as 123.123.123.123.

- If you are using a proxy server, then temporarily disable it to load the web page correctly.

**2** Click **Address Book**.

**3** From the Contacts section, add a contact.

**Note:** You can assign the contact to one or more groups.

**4** If necessary, specify a login method to allow application access.

**5** Apply the changes.

## Adding groups

**1** Open a web browser, and then type the printer IP address in the address field.

**Notes:**

- View the printer IP address on the printer home screen. The IP address appears as four sets of numbers separated by periods, such as 123.123.123.123.
- If you are using a proxy server, then temporarily disable it to load the web page correctly.

**2** Click **Address Book**.

**3** From the Contact Groups section, add a group name.

**Note:** You can assign one or more contacts to the group.

**4** Apply the changes.

## Editing contacts or groups

**1** Open a web browser, and then type the printer IP address in the address field.

**Notes:**

- View the printer IP address on the printer home screen. The IP address appears as four sets of numbers separated by periods, such as 123.123.123.123.
- If you are using a proxy server, then temporarily disable it to load the web page correctly.

**2** Click **Address Book**.

**3** Do either of the following:

- From the Contacts section, click a contact name, and then edit the information.
- From the Contact Groups section, click a group name, and then edit the information.

**4** Apply the changes.

## Deleting contacts or groups

**1** Open a web browser, and then type the printer IP address in the address field.

**Notes:**

- View the printer IP address on the printer home screen. The IP address appears as four sets of numbers separated by periods, such as 123.123.123.123.

- If you are using a proxy server, then temporarily disable it to load the web page correctly.

**2** Click **Address Book**.

**3** Do either of the following:

- From the Contacts section, select a contact that you want to delete.
- From the Contact Groups section, select a group name that you want to delete.

# Setting up and using the accessibility features

## Notes:

- These features are supported only in some printer models.
- For more information on the accessibility features of your printer model, see the Accessibility Guide at <http://support.lexmark.com>.

## Activating Voice Guidance

### From the control panel

- 1 Press and hold the **5** key until you hear a voice message.
- 2 Select **OK**.

### From the keyboard

- 1 Press and hold the **5** key until you hear a voice message.
- 2 Press **Tab** to navigate the focus cursor to the OK button, and then press **Enter**.

## Notes:

- Voice Guidance is also activated when you insert headphones into the headphone jack.
- To adjust the volume, use the volume buttons at the bottom part of the control panel.

## Navigating the screen using gestures

## Notes:

- The gestures are applicable only when Voice Guidance is activated.
- Enable Magnification to use the zoom and pan gestures.
- Use a physical keyboard to type characters and adjust certain settings.

Gesture	Function
Double-tap	Select an option or item on the screen.
Triple-tap	Zoom in or zoom out text and images.
Swipe right or swipe down	Move to the next item on the screen.
Swipe left or swipe up	Move to the previous item on the screen.
Pan	Access parts of the zoomed image that are beyond the limits of the screen. <b>Note:</b> This gesture requires the use of two fingers to drag across a zoomed image.
Swipe up then left	Exit an application and return to the home screen.

Gesture	Function
Swipe down then left	<ul style="list-style-type: none"><li>• Cancel a job.</li><li>• Go back to the previous setting.</li><li>• Exit the screen that appears without changing any setting or value.</li></ul>
Swipe up then down	Repeat a spoken prompt.

## Enabling Magnification mode

- 1 From the control panel, press and hold the **5** key until you hear a voice message.
- 2 Select **Magnification mode**.
- 3 Select **OK**.

For more information on navigating a magnified screen, see [“Navigating the screen using gestures” on page 25](#).

## Adjusting the Voice Guidance speech rate

- 1 From the home screen, select **Settings > Device > Accessibility > Speech Rate**.
- 2 Select the speech rate.

## Using the keyboard on the display

Do one or more of the following:

- Drag a finger over the key to announce the character.
- Lift the finger to enter or type the character in the field.
- Select **Backspace** to delete characters.
- To hear the content in the input field, select **Tab**, and then select **Shift + Tab**.

## Enabling spoken passwords or personal identification numbers

- 1 From the home screen, select **Settings > Device > Accessibility > Speak Passwords/PINs**.
- 2 Enable the setting.

# Loading paper and specialty media

## Setting the paper size and type

- 1 From the control panel, navigate to:  
**Settings > Paper > Tray Configuration > Paper Size/Type** > select a paper source  
  
For non-touch-screen printer models, press  to navigate through the settings.
- 2 Set the paper size and type.

## Configuring Universal paper settings

- 1 From the control panel, navigate to:  
**Settings > Paper > Media Configuration > Universal Setup**  
  
For non-touch-screen printer models, press  to navigate through the settings.
- 2 Configure the settings.

## Loading the 250- or 550-sheet tray

 **CAUTION—POTENTIAL INJURY:** To reduce the risk of equipment instability, load each tray separately. Keep all other trays closed until needed.

- 1 Remove the tray.  
**Note:** To avoid paper jams, do not remove trays while the printer is busy.



- 2 Adjust the guides to match the size of the paper that you are loading.  
**Note:** Use the indicators on the bottom of the tray to position the guides.

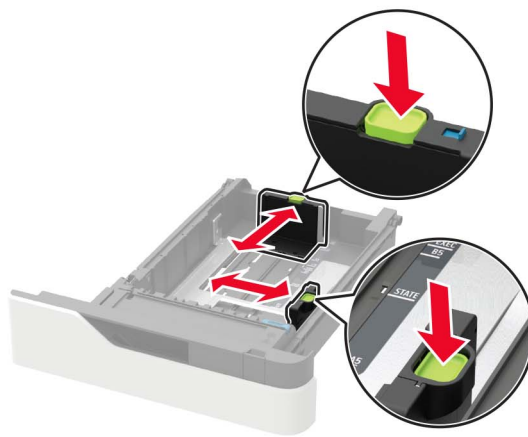
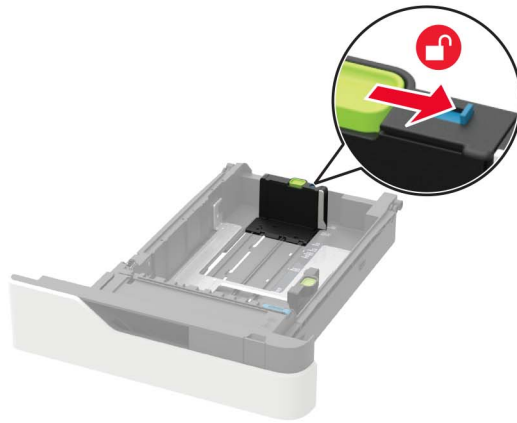

**3** Flex, fan, and align the paper edges before loading.

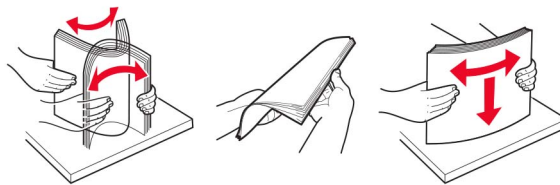

**4** Load the paper stack with the printable side facedown, and then make sure that the side guides fit snugly against the paper.





- Do not slide paper into the tray.
- To avoid paper jams, make sure that the stack height is below the maximum paper fill indicator.



- Load letterhead depending on whether an optional staple finisher is installed or not.

Without an optional staple finisher	With an optional staple finisher
<p>One-sided printing</p>	<p>One-sided printing</p>
<p>Two-sided printing</p>	<p>Two-sided printing</p>

- When loading prepunched paper, make sure that the holes on the long edge of the paper are against the right side of the tray.

One-sided printing	Two-sided printing

- Load envelopes with the flap side up and against the left side of the tray.

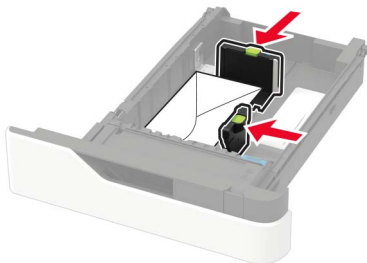

**Warning—Potential Damage:** Do not use envelopes with stamps, clasps, snaps, windows, coated linings, or self-stick adhesives.

- 5 Insert the tray.
- 6 From the control panel, set the paper size and paper type to match the paper loaded.

## Loading the 2100-sheet tray

**CAUTION—TIPPING HAZARD:** To reduce the risk of equipment instability, load each tray separately. Keep all other trays closed until needed.

- 1 Pull out the tray.
- 2 Adjust the guides.

### Loading A5-size paper

- a Pull up and slide the width guide to the position for A5.



- b** Squeeze and slide the length guide to the position for A5 until it *clicks* into place.



- c** Remove the A5 length guide from its holder.

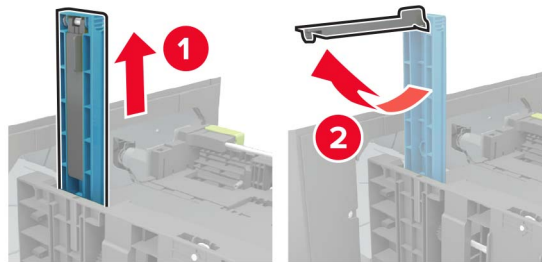

- d** Insert the guide into its designated slot, and then press until it *clicks* into place.

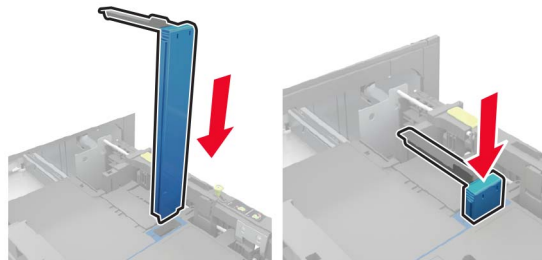

## Loading A4-, letter-, legal-, Oficio-, and folio-size paper

- a Pull up and slide the width guide to the correct position for the size of the paper being loaded.



- b If the A5 length guide is still attached, then remove it. If the guide is not attached, then proceed to [step d on page 33](#).

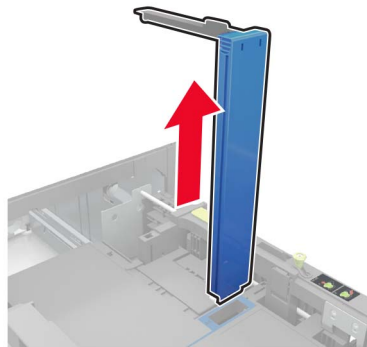

- c Place the A5 length guide in its holder.

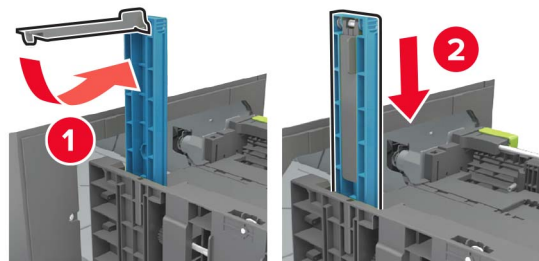

- d Squeeze, and then slide the length guide to the correct position for the size of the paper being loaded.

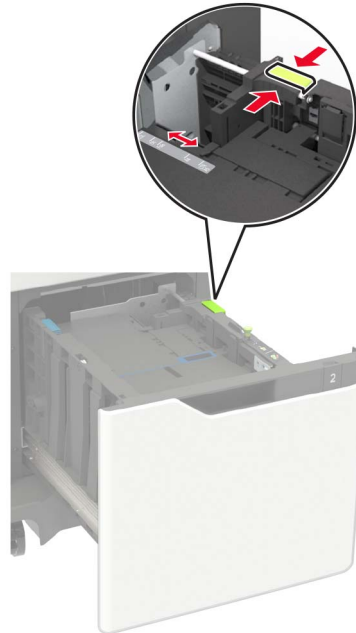

- 3 Flex, fan, and align the paper edges before loading.

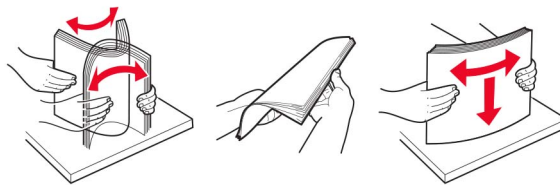

- 4 Load the paper stack with the printable side facedown.

- Load letterhead depending on whether an optional staple finisher is installed or not.

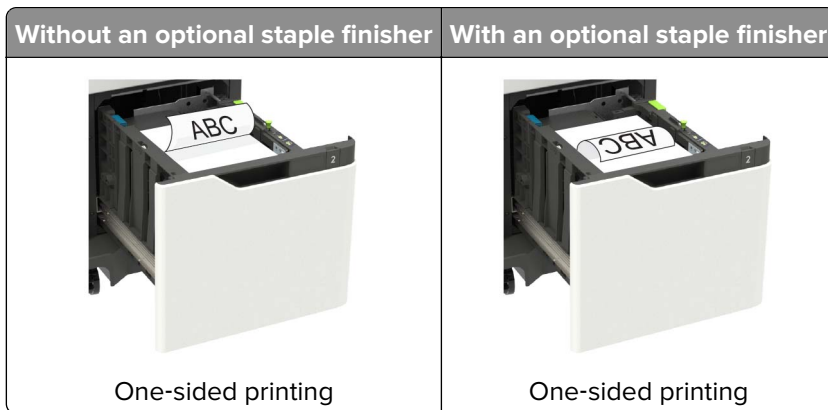

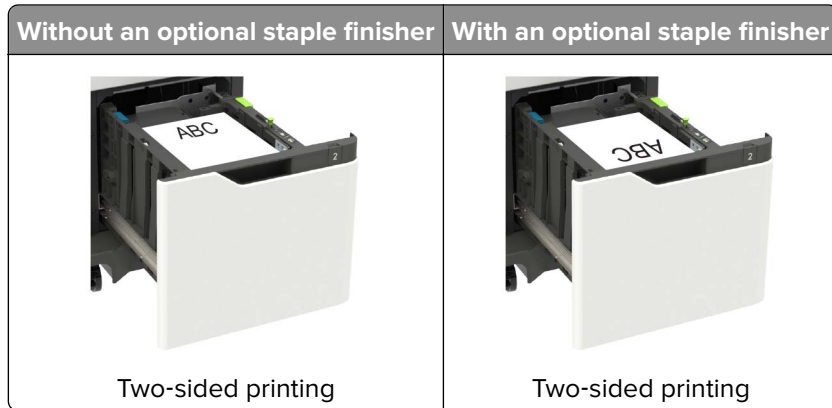

- When loading prepunched paper, make sure that the holes on the long edge of the paper are against the right side of the tray.

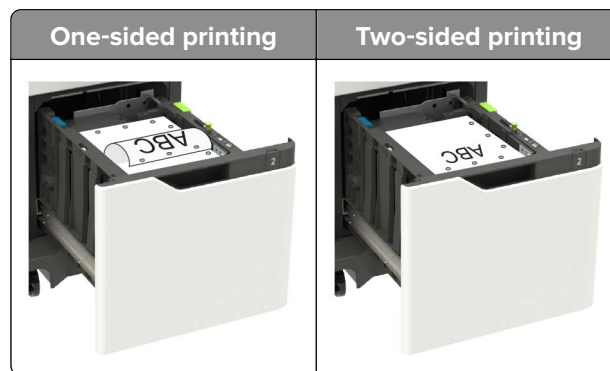

**5** Insert the tray.

**Note:** Press down the paper stack while inserting the tray.

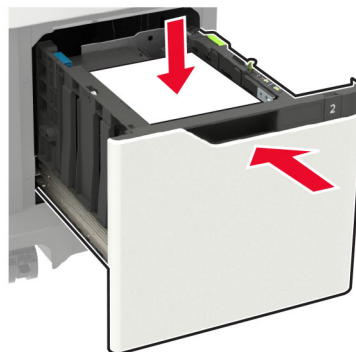

**6** From the control panel, set the paper size and paper type to match the paper loaded.

## Loading the multipurpose feeder

- 1 Open the multipurpose feeder.



- 2 Adjust the guide to match the size of the paper that you are loading.



- 3 Flex, fan, and align the paper edges before loading.

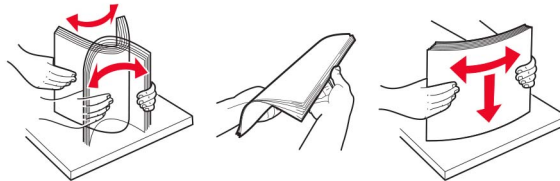

- 4 Load paper with the printable side faceup.

- Load letterhead depending on whether an optional staple finisher is installed or not.

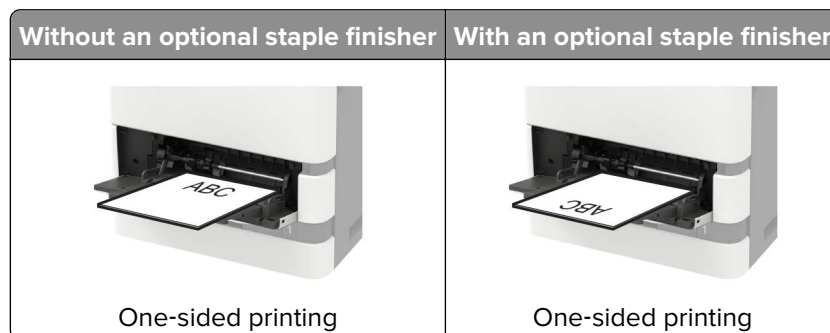

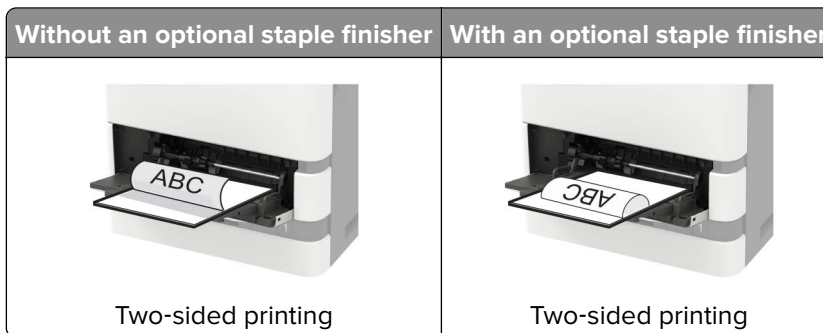

- When loading prepunched paper, make sure that the holes on the long edge of the paper are against the right side of the paper guide.

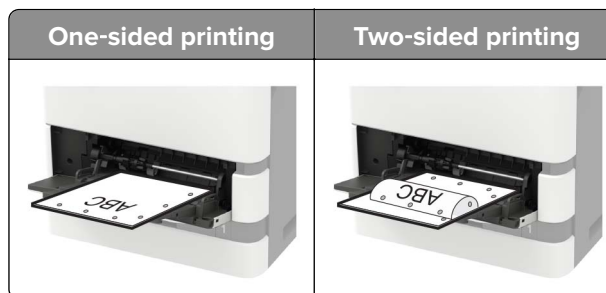

- Load envelopes with the flap side down and against the left side of the paper guide.

**Warning—Potential Damage:** Do not use envelopes with stamps, clasps, snaps, windows, coated linings, or self-stick adhesives.

- 5 From the control panel, set the paper size and paper type to match the paper loaded.

## Linking trays

- 1 Open a web browser, and then type the printer IP address in the address field.

### Notes:

- View the printer IP address on the printer home screen. The IP address appears as four sets of numbers separated by periods, such as 123.123.123.123.
- If you are using a proxy server, then temporarily disable it to load the web page correctly.

- 2 Click **Settings > Paper > Tray Configuration**.
- 3 Set the same paper size and paper type for the trays that you are linking.
- 4 Save the settings.
- 5 Click **Settings > Device > Maintenance > Configuration Menu > Tray Configuration**.
- 6 Set Tray Linking to **Automatic**.
- 7 Save the settings.

To unlink trays, make sure that no trays have the same paper size and paper type settings.

**Warning—Potential Damage:** The temperature of the fuser varies according to the specified paper type. To avoid printing issues, match the paper type setting in the printer with the paper loaded in the tray.



# Paper support

## Supported paper sizes

### Paper sizes supported by the printer

Paper size	Standard 550-sheet tray, optional 250- or 550-sheet tray	Optional 2100-sheet tray	Multipurpose feeder	Two-sided printing
<b>A4</b> 210 x 297 mm (8.3 x 11.7 in.)	✓	✓	✓	✓
<b>A5 LEF<sup>1</sup></b> 210 x 148 mm (8.3 x 5.8 in.)	✓	✓	✓	✓
<b>A5 SEF<sup>1</sup></b> 148 x 210 mm (5.8 x 8.3 in.)	✓	x	✓	x
<b>A6</b> 105 x 148 mm (4.1 x 5.8 in.)	✓	x	✓	✓
<b>JIS B5</b> 182 x 257 mm (7.2 x 10.1 in.)	✓	x	✓	✓
<b>Oficio (Mexico)</b> 216 x 340 mm (8.5 x 13.4 in.)	✓	✓	✓	✓
<b>Statement</b> 140 x 216 mm (5.5 x 8.5 in.)	✓	x	✓	✓
<b>Executive</b> 184 x 267 mm (7.3 x 10.5 in.)	✓	x	✓	✓
<b>Letter</b> 216 x 279 mm (8.5 x 11 in.)	✓	✓	✓	✓
<b>Legal</b> 216 x 356 mm (8.5 x 14 in.)	✓	✓	✓	✓
<b>Folio</b> 216 x 330 mm (8.5 x 13 in.)	✓	✓	✓	✓
<b>Universal</b> 105 x 148 mm (4.1 x 5.8 in.) to 216 x 356 mm (8.5 x 14 in.)	✓	x	✓	✓
<b>7 3/4 Envelope (Monarch)<sup>3</sup></b> 98 x 191 mm (3.9 x 7.5 in.)	✓	x	✓	x

<sup>1</sup> A5 long edge feed (LEF) is recommended over A5 short edge feed (SEF).

<sup>2</sup> Envelopes wider than 101.6 mm (4.5 in.) may crease. This paper type must be tested for acceptability.

<sup>3</sup> Envelopes are not supported on Lexmark MS725.

Paper size	Standard 550-sheet tray, optional 250- or 550-sheet tray	Optional 2100-sheet tray	Multipurpose feeder	Two-sided printing
<b>9 Envelope</b> <sup>3</sup> 98 x 225 mm (3.9 x 8.9 in.)	✓	X	✓	X
<b>10 Envelope</b> <sup>2,3</sup> 105 x 241 mm (4.1 x 9.5 in.)	✓	X	✓	X
<b>DL Envelope</b> <sup>2,3</sup> 110 x 220 mm (4.3 x 8.7 in.)	✓	X	✓	X
<b>C5 Envelope</b> <sup>2,3</sup> 162 x 229 mm (6.4 x 9 in.)	✓	X	✓	X
<b>B5 Envelope</b> <sup>2,3</sup> 176 x 250 mm (6.9 x 9.8 in.)	✓	X	✓	X
<b>Other Envelope</b> <sup>2,3</sup> 98.4 x 162 mm (3.9 x 6.4 in.) to 176 x 250 mm (6.9 x 9.8 in.)	✓	X	✓	X

<sup>1</sup> A5 long edge feed (LEF) is recommended over A5 short edge feed (SEF).

<sup>2</sup> Envelopes wider than 101.6 mm (4.5 in.) may crease. This paper type must be tested for acceptability.

<sup>3</sup> Envelopes are not supported on Lexmark MS725.

## Paper sizes supported by the output options or finishers

Paper size	Output expander or high-capacity output expander	4-bin mailbox	Staple finisher		Staple, hole punch finisher		
			Stack	Staple	Stack	Staple	Hole punch
<b>A4</b> 210 x 297 mm (8.3 x 11.7 in.)	✓	✓	✓	✓	✓	✓	✓
<b>A5 LEF</b> 210 x 148 mm (8.3 x 5.8 in.)	✓	✓	✓	✓	✓	✓	X
<b>A5 SEF</b> 148 x 210 mm (5.8 x 8.3 in.)	✓	✓	✓	X	✓	X	X
<b>A6</b> 105 x 148 mm (4.1 x 5.8 in.)	✓	✓	X	X	X	X	X
<b>JIS B5</b> 182 x 257 mm (7.2 x 10.1 in.)	✓	✓	✓	X	✓	X	X

Paper size	Output expander or high-capacity output expander	4-bin mailbox	Staple finisher		Staple, hole punch finisher		
			Stack	Staple	Stack	Staple	Hole punch
<b>Oficio (Mexico)</b> 216 x 340 mm (8.5 x 13.4 in.)	✓	✓	✓	✓	✓	✓	✓
<b>Statement</b> 140 x 216 mm (5.5 x 8.5 in.)	✓	✓	✓	X	✓	X	X
<b>Executive</b> 184 x 267 mm (7.3 x 10.5 in.)	✓	✓	✓	X	✓	X	X
<b>Letter</b> 216 x 279 mm (8.5 x 11 in.)	✓	✓	✓	✓	✓	✓	✓
<b>Legal</b> 216 x 356 mm (8.5 x 14 in.)	✓	✓	✓	✓	✓	✓	X
<b>Folio</b> 216 x 330 mm (8.5 x 13 in.)	✓	✓	✓	✓	✓	✓	✓
<b>Universal</b> 105 x 148 mm (4.1 x 5.8 in.) to 216 x 356 mm (8.5 x 14 in.)	✓	✓	X	X	X	X	X
<b>7 3/4 Envelope (Monarch)</b> 98 x 191 mm (3.9 x 7.5 in.)	✓	X	X	X	X	X	X
<b>9 Envelope</b> 98 x 225 mm (3.9 x 8.9 in.)	✓	X	X	X	X	X	X
<b>10 Envelope</b> 105 x 241 mm (4.1 x 9.5 in.)	✓	X	X	X	X	X	X
<b>DL Envelope</b> 110 x 220 mm (4.3 x 8.7 in.)	✓	X	X	X	X	X	X
<b>C5 Envelope</b> 162 x 229 mm (6.4 x 9 in.)	✓	X	X	X	X	X	X

Paper size	Output expander or high-capacity output expander	4-bin mailbox	Staple finisher		Staple, hole punch finisher		
			Stack	Staple	Stack	Staple	Hole punch
<b>B5 Envelope</b> 176 x 250 mm (6.9 x 9.8 in.)	✓	X	X	X	X	X	X
<b>Other Envelopes</b> 98.4 x 162 mm (3.9 x 6.4 in.) to 176 x 250 mm (6.9 x 9.8 in.)	✓	X	X	X	X	X	X

## Supported paper types

### Paper types supported by the printer

Paper type	Standard 550-sheet tray, optional 250- or 550-sheet tray	Optional 2100-sheet tray	Multipurpose feeder	Two-sided printing
Plain paper	✓	✓	✓	✓
Card stock	✓	X	✓	✓
Transparency <sup>1</sup>	✓	X	✓	X
Labels	✓	X	✓	X
Vinyl Labels	✓	X	✓	X
Bond	✓	✓	✓	✓
Envelope	✓	X	✓	X
Rough Envelope	✓	X	✓	X
Letterhead	✓	✓	✓	✓
Preprinted	✓	✓	✓	✓
Colored Paper	✓	X	✓	✓

<sup>1</sup> To prevent transparencies from sticking together, print up to 20 pages only. Print the succeeding pages after three minutes.

Paper type	Standard 550-sheet tray, optional 250- or 550-sheet tray	Optional 2100-sheet tray	Multipurpose feeder	Two-sided printing
Light	✓	X	✓	✓
Heavy	✓	X	✓	✓
Rough/Cotton	✓	X	✓	✓
Custom Type [x]	✓	X	✓	✓

<sup>1</sup> To prevent transparencies from sticking together, print up to 20 pages only. Print the succeeding pages after three minutes.

## Paper types supported by the output options or finishers

Paper type	Output expander or high-capacity output expander	4-bin mailbox	Staple finisher		Staple, hole punch finisher		
			Stack	Staple	Stack	Staple	Hole punch
Plain paper	✓	✓	✓	✓	✓	✓	✓
Card stock	✓	X	X	X	X	X	X
Transparencies	✓	X	✓	X	✓	X	X
Labels	✓	X	X	X	X	X	X
Vinyl Labels	✓	X	X	X	X	X	X
Bond	✓	✓	✓	✓	✓	✓	✓
Envelope	✓	X	X	X	X	X	X
Rough Envelope	✓	X	X	X	X	X	X
Letterhead	✓	✓	✓	✓	✓	✓	✓
Preprinted	✓	✓	✓	✓	✓	✓	✓
Colored Paper	✓	X	X	X	X	X	X
Light	✓	X	X	X	X	X	X
Heavy	✓	X	X	X	X	X	X

Paper type	Output expander or high-capacity output expander	4-bin mailbox	Staple finisher		Staple, hole punch finisher		
			Stack	Staple	Stack	Staple	Hole punch
Rough/Cotton	✓	X	X	X	X	X	X
Custom Type [x]	✓	X	X	X	X	X	X

## Supported paper weights

### Paper weights supported by the printer

Paper type and weight	Standard 550-sheet tray, optional 250- or 550-sheet tray	Optional 2100-sheet tray	Multipurpose feeder	Two-sided printing
<b>Plain paper or Bond<sup>1</sup></b> 60–176 g/m <sup>2</sup> grain long (16–47-lb bond)	✓	✓	✓	✓
<b>Card stock</b> 203 g/m <sup>2</sup> grain long (125-lb bond)	✓	X	✓	✓
<b>Card stock</b> 199 g/m <sup>2</sup> grain long (110-lb bond)	✓	X	✓	✓
<b>Card stock</b> 176 g/m <sup>2</sup> grain long (65-lb bond)	✓	X	✓	✓
<b>Transparency</b> 138–146 g/m <sup>2</sup> grain long (37–39-lb bond)	✓	X	✓	X
<b>Paper labels</b> 180 g/m <sup>2</sup> (48-lb bond)	✓	X	✓	✓
<b>Integrated forms<sup>2</sup></b> 140–175 g/m <sup>2</sup> (37–47-lb bond)	✓	X	✓	✓

<sup>1</sup> Grain short is preferred for paper over 176 g/m<sup>2</sup> (47 lb).

<sup>2</sup> Pressure-sensitive area must enter the printer first.

<sup>3</sup> 28-lb bond envelopes are limited to 25% cotton content.

Paper type and weight	Standard 550-sheet tray, optional 250- or 550-sheet tray	Optional 2100-sheet tray	Multipurpose feeder	Two-sided printing
<b>Integrated forms</b> 75–135 g/m <sup>2</sup> (20–36-lb bond)	✓	X	✓	✓
<b>Envelopes<sup>3</sup></b> 60–105 g/m <sup>2</sup> (16–28-lb bond)	✓	X	✓	✓

<sup>1</sup> Grain short is preferred for paper over 176 g/m<sup>2</sup> (47 lb).  
<sup>2</sup> Pressure-sensitive area must enter the printer first.  
<sup>3</sup> 28-lb bond envelopes are limited to 25% cotton content.

## Paper weights supported by the output options or finishers

Paper type and weight	Output expander or high-capacity output expander	4-bin mailbox	Staple finisher		Staple, hole punch finisher		
			Stack	Staple	Stack	Staple	Hole punch
<b>Plain paper or Bond</b> 60–176 g/m <sup>2</sup> grain long (16–47-lb bond)	✓	X	✓	X	✓	X	X
<b>Plain paper or Bond</b> 60–90 g/m <sup>2</sup> grain long (16–24-lb bond)	✓	✓	✓	✓	✓	✓	✓
<b>Card stock</b> 203 g/m <sup>2</sup> grain long (125-lb bond)	✓	X	✓	X	✓	X	X
<b>Card stock</b> 199 g/m <sup>2</sup> grain long (110-lb bond)	✓	X	✓	X	✓	X	X
<b>Card stock</b> 176 g/m <sup>2</sup> grain long (65-lb bond)	✓	X	X	X	X	X	X

Paper type and weight	Output expander or high-capacity output expander	4-bin mailbox	Staple finisher		Staple, hole punch finisher		
			Stack	Staple	Stack	Staple	Hole punch
<b>Card stock</b> 163 g/m <sup>2</sup> grain long (90-lb bond)	✓	X	✓	X	✓	X	X
<b>Transparency</b> 138–146 g/m <sup>2</sup> grain long (37–39-lb bond)	✓	X	✓	X	✓	X	X
<b>Paper labels</b> 180 g/m <sup>2</sup> (48-lb bond)	✓	X	X	X	X	X	X
<b>Integrated forms</b> 140–175 g/m <sup>2</sup> (37–47-lb bond)	✓	X	X	X	X	X	X
<b>Integrated forms</b> 75–135 g/m <sup>2</sup> (20–36-lb bond)	✓	X	X	X	X	X	X
<b>Envelopes</b> 60–105 g/m <sup>2</sup> (16–28-lb bond)	✓	X	X	X	X	X	X



# Printing

## Printing from a computer

**Note:** For labels, card stock, and envelopes, set the paper size and type in the printer before printing the document.

- 1 From the document that you are trying to print, open the Print dialog.
- 2 If necessary, adjust the settings.
- 3 Print the document.

## Printing from a mobile device

### Printing from a mobile device using Lexmark Mobile Print

Lexmark™ Mobile Print allows you to send documents and images directly to a supported Lexmark printer.

- 1 Open the document, and then send or share the document to Lexmark Mobile Print.

**Note:** Some third-party applications may not support the send or share feature. For more information, see the documentation that came with the application.

- 2 Select a printer.
- 3 Print the document.

### Printing from a mobile device using Google Cloud Print

Google Cloud Print™ is a mobile printing service that allows enabled applications on mobile devices to print to any Google Cloud Print-ready printer.

- 1 From the home screen of your mobile device, launch an enabled application.
- 2 Tap **Print**, and then select a printer.
- 3 Print the document.

### Printing from a mobile device using Mopria Print Service

Mopria® Print Service is a mobile printing solution for mobile devices running on Android version 4.4 or later. It allows you to print directly to any Mopria-certified printer.

**Note:** Before printing, make sure that the Mopria Print Service is enabled.

- 1 From the home screen of your mobile device, launch a compatible application.
- 2 Tap **Print**, and then select a printer.
- 3 Print the document.

## Printing from a mobile device using AirPrint

AirPrint is a mobile printing solution that allows you to print directly from Apple devices to an AirPrint-certified printer.

### Notes:

- This application is supported only in some Apple devices.
- This application is supported only in some printer models.

- 1 From the home screen of your mobile device, launch a compatible application.
- 2 Select an item to print, and then tap the share icon.
- 3 Tap **Print**, and then select a printer.
- 4 Print the document.

## Printing from a flash drive

- 1 Insert the flash drive.



### Notes:

- If you insert the flash drive when an error message appears, then the printer ignores the flash drive.
  - If you insert the flash drive while the printer is processing other print jobs, then **Busy** appears on the display.
- 2 From the display, touch the document that you want to print.  
If necessary, configure other print settings.
  - 3 Send the print job.  
To print another document, touch **USB Drive**.

**Warning—Potential Damage:** To avoid loss of data or printer malfunction, do not touch the flash drive or the printer in the area shown while actively printing, reading, or writing from the memory device.



## Supported flash drives and file types

### Flash drives

- Lexar JumpDrive S70 (16GB and 32GB)
- SanDisk Cruzer (16GB and 32GB)
- PNY Attache (16GB and 32GB)

### Notes:

- The printer supports high-speed USB flash drives with full-speed standard.
- USB flash drives must support the File Allocation Table (FAT) system.

### File types

#### Documents

- PDF (version 1.7 or earlier)
- HTML
- XPS
- Microsoft file formats (.doc, .docx, .xls, .xlsx, .ppt, .pptx)

#### Images

- .dcx
- .gif
- .JPEG or .jpg
- .bmp
- .pcx
- .TIFF or .tif
- .png

## Configuring confidential jobs

- From the control panel, navigate to:  
**Settings > Security > Confidential Print Setup**

For non-touch-screen printer models, press  to navigate through the settings.

- Configure the settings.

Use	To
Max Invalid PIN	Set the number of times an invalid PIN can be entered. <b>Note:</b> When the limit is reached, the print jobs for that user name are deleted.
Confidential Job Expiration	Set the expiration time for confidential print jobs. <b>Note:</b> Confidential held jobs are stored in the printer until they are released or deleted manually.
Repeat Job Expiration	Set the expiration time for a repeat print job. <b>Note:</b> Repeat held jobs are stored in the printer memory for reprinting.
Verify Job Expiration	Set the expiration time that the printer prints a copy before printing the remaining copies. <b>Note:</b> Verify jobs print one copy to check if it is satisfactory before printing the remaining copies.
Reserve Job Expiration	Set the expiration time that the printer stores print jobs. <b>Note:</b> Reserve held jobs are automatically deleted after printing.
Require All Jobs to be Held	Set the printer to hold all print jobs.

## Printing confidential and other held jobs

### For Windows users

- With a document open, click **File > Print**.
- Click **Properties, Preferences, Options, or Setup**.
- Click **Print and Hold**.
- Select **Use Print and Hold**, and then assign a user name.
- Select the print job type (Confidential, Repeat, Reserve, or Verify).  
If the print job is confidential, then enter a four-digit PIN.
- Click **OK** or **Print**.

7 From the printer home screen, release the print job.

- For confidential print jobs, navigate to:  
**Held jobs** > select your user name > **Confidential** > enter the PIN > select the print job > configure the settings > **Print**
- For other print jobs, navigate to:  
**Held jobs** > select your user name > select the print job > configure the settings > **Print**

## For Macintosh users

1 With a document open, choose **File** > **Print**.

If necessary, click the disclosure triangle to see more options.

2 From the print options or Copies & Pages menu, choose **Job Routing**.

3 Select the print job type (Confidential, Repeat, Reserve, or Verify).

If the print job is confidential, then assign a user name and a four-digit PIN.

4 Click **OK** or **Print**.

5 From the printer home screen, release the print job.

- For confidential print jobs, navigate to:  
**Held jobs** > select your user name > **Confidential** > enter the PIN > select the print job > configure the settings > **Print**
- For other print jobs, navigate to:  
**Held jobs** > select your user name > select the print job > configure the settings > **Print**

## Printing from a Cloud Connector profile

1 From the home screen, touch **Cloud Connector**.

2 Select a cloud service provider, and then select a profile.

**Note:** For more information on creating a Cloud Connector profile, see [“Creating a Cloud Connector profile” on page 20](#).

3 Select a file.

**Note:** You cannot select an unsupported file.

4 If necessary, change the settings.

5 Touch **Print**.

## Printing a font sample list

1 From the control panel, navigate to:

**Settings** > **Reports** > **Print** > **Print Fonts**

For non-touch-screen printer models, press  to navigate through the settings.

2 Select a font sample.

## Printing a directory list

From the control panel, navigate to:

**Settings > Reports > Print > Print Directory**

For non-touch-screen printer models, press  to navigate through the settings.

# Understanding the printer menus

## Menu map

<b>Device</b>	<ul style="list-style-type: none"> <li>• <a href="#">Preferences</a></li> <li>• <a href="#">Remote Operator Panel</a></li> <li>• <a href="#">Notifications</a></li> <li>• <a href="#">Power Management</a></li> <li>• <a href="#">Information Sent to Lexmark</a></li> </ul>	<ul style="list-style-type: none"> <li>• <a href="#">Accessibility</a></li> <li>• <a href="#">Restore Factory Defaults</a></li> <li>• <a href="#">Maintenance</a></li> <li>• <a href="#">Visible Home Screen Icons</a></li> <li>• <a href="#">About this Printer</a></li> </ul>
<b>Print</b>	<ul style="list-style-type: none"> <li>• <a href="#">Layout</a></li> <li>• <a href="#">Setup</a></li> <li>• <a href="#">Quality</a></li> <li>• <a href="#">Job Accounting</a></li> <li>• <a href="#">XPS</a></li> </ul>	<ul style="list-style-type: none"> <li>• <a href="#">PDF</a></li> <li>• <a href="#">PostScript</a></li> <li>• <a href="#">PCL</a></li> <li>• <a href="#">HTML</a></li> <li>• <a href="#">Image</a></li> </ul>
<b>Paper</b>	<ul style="list-style-type: none"> <li>• <a href="#">Tray Configuration</a></li> </ul>	<ul style="list-style-type: none"> <li>• <a href="#">Media Configuration</a></li> </ul>
<b>Network/Ports</b>	<ul style="list-style-type: none"> <li>• <a href="#">Network Overview</a></li> <li>• <a href="#">Wireless</a></li> <li>• <a href="#">Ethernet</a></li> <li>• <a href="#">TCP/IP</a></li> <li>• <a href="#">SNMP</a></li> <li>• <a href="#">IPSec</a></li> </ul>	<ul style="list-style-type: none"> <li>• <a href="#">802.1x</a></li> <li>• <a href="#">LPD Configuration</a></li> <li>• <a href="#">HTTP/FTP Settings</a></li> <li>• <a href="#">ThinPrint</a></li> <li>• <a href="#">USB</a></li> <li>• <a href="#">Google Cloud Print</a></li> </ul>
<b>USB Drive</b>	<ul style="list-style-type: none"> <li>• <a href="#">Flash Drive Print</a></li> </ul>	
<b>Security</b>	<ul style="list-style-type: none"> <li>• <a href="#">Login methods</a></li> <li>• <a href="#">Schedule USB Devices</a></li> <li>• <a href="#">Security Audit Log</a></li> <li>• <a href="#">Login Restrictions</a></li> <li>• <a href="#">Confidential Print Setup</a></li> </ul>	<ul style="list-style-type: none"> <li>• <a href="#">Solutions LDAP Settings</a></li> <li>• <a href="#">Disk Encryption</a></li> <li>• <a href="#">Erase Temporary Data Files</a></li> <li>• <a href="#">Mobile Services Management</a></li> <li>• <a href="#">Miscellaneous</a></li> </ul>
<b>Reports</b>	<ul style="list-style-type: none"> <li>• <a href="#">Menu Settings Page</a></li> <li>• <a href="#">Device</a></li> </ul>	<ul style="list-style-type: none"> <li>• <a href="#">Print</a></li> <li>• <a href="#">Network</a></li> </ul>
<b><a href="#">Help</a></b>	<ul style="list-style-type: none"> <li>• Print All Guides</li> <li>• Connection Guide</li> <li>• Information Guide</li> <li>• Media Guide</li> </ul>	<ul style="list-style-type: none"> <li>• Mono Quality Guide</li> <li>• Moving Guide</li> <li>• Print Quality Guide</li> <li>• Supplies Guide</li> </ul>
<b><a href="#">Troubleshooting</a></b>	<ul style="list-style-type: none"> <li>• Print Quality Test Pages</li> </ul>	

# Device

## Preferences

Menu item	Description
<b>Display Language</b> [List of languages]	Set the language of the text that appears on the display.
<b>Country/Region</b> [List of countries or regions]	Identify the country or region where the printer is configured to operate.
<b>Run initial setup</b> Off* On	Run the setup wizard.
<b>Keyboard</b> Keyboard Type [List of languages]	Select a language as a keyboard type. <b>Notes:</b> <ul style="list-style-type: none"> <li>All the Keyboard Type values may not appear or may require special hardware to appear.</li> <li>This menu item appears only in some printer models.</li> </ul>
<b>Displayed information</b> Display Text 1 [IP Address*] Display Text 2 [Date/Time*] Custom Text 1 Custom Text 2	Specify the information to appear on the home screen. <b>Note:</b> Custom Text 1 and Custom Text 2 appear only in some printer models.
<b>Date and Time</b> Configure Current Date and Time Manually Set Date and Time Date Format [MM-DD-YYYY*] Time Format [12 hour A.M./P.M.*] Time Zone [GMT*]	Configure the printer date and time.
<b>Date and Time</b> Network Time Protocol Enable NTP [On*] NTP Server Enable Authentication	Configure the settings for Network Time Protocol (NTP). <b>Notes:</b> <ul style="list-style-type: none"> <li>Enable Authentication appears only in some printer models.</li> <li>When Enable Authentication is set to MD5 key, Key ID and Password appear.</li> </ul>
<b>Paper Sizes</b> U.S.* Metric	Specify the unit of measurement for paper sizes. <b>Note:</b> The country or region selected in the initial setup wizard determines the initial paper size setting.
<b>Screen Brightness</b> 20–100% (100*)	Adjust the brightness of the display. <b>Note:</b> This menu item appears only in some printer models.
<b>Note:</b> An asterisk (*) next to a value indicates the factory default setting.	



Menu item	Description
<b>Flash Drive Access</b> Enabled* Disabled	Enable access to the flash drive. <b>Note:</b> This menu item appears only in some printer models.
<b>Screen Timeout</b> 5–300 (60*)	Set the idle time in seconds before the display shows the home screen, or before the printer logs off a user account automatically.
<b>Note:</b> An asterisk (*) next to a value indicates the factory default setting.	

## Remote Operator Panel

Menu item	Description
<b>External VNC Connection</b> Don't Allow* Allow	Connect an external Virtual Network Computing (VNC) client to the remote control panel.
<b>Authentication Type</b> None* Standard Authentication	Set the authentication type when accessing the VNC client server. <b>Note:</b> When set to Standard Authentication, VNC Password appears.
<b>Note:</b> An asterisk (*) next to a value indicates the factory default setting.	

## Notifications

Menu item	Description
<b>Error Lighting</b> Off On*	Set the indicator light to come on when a printer error occurs. <b>Note:</b> This menu item appears only in some printer models.
<b>Alarm Control</b> Off Single* Continuous	Set the number of times that the alarm sounds when the printer requires user intervention. <b>Note:</b> This menu item appears only in some printer models.
<b>Supplies</b> Show Supply Estimates Show estimates* Do not show estimates	Show the estimated status of the supplies.
<b>Supplies</b> Cartridge Alarm Off Single* Continuous	Set the number of times that the alarm sounds when the toner cartridge is low. <b>Note:</b> This menu item appears only in some printer models.
<b>Note:</b> An asterisk (*) next to a value indicates the factory default setting.	

Menu item	Description
<b>E-mail Alerts Setup</b> E-mail Setup Primary SMTP Gateway	Type the IP address or host name of the primary SMTP server for sending e-mail. <b>Note:</b> This menu item appears only in some printer models.
<b>E-mail Alerts Setup</b> E-mail Setup Primary SMTP Gateway Port 1–65535 (25*)	Enter the port number of the primary SMTP server. <b>Note:</b> This menu item appears only in some printer models.
<b>E-mail Alerts Setup</b> E-mail Setup Secondary SMTP Gateway	Type the server IP address or host name of your secondary or backup SMTP server. <b>Note:</b> This menu item appears only in some printer models.
<b>E-mail Alerts Setup</b> E-mail Setup Secondary SMTP Gateway Port 1–65535 (25*)	Enter the server port number of your secondary or backup SMTP server. <b>Note:</b> This menu item appears only in some printer models.
<b>E-mail Alerts Setup</b> E-mail Setup SMTP Timeout 5-30 seconds (30*)	Specify how long before the printer times out if the SMTP server does not respond. <b>Note:</b> This menu item appears only in some printer models.
<b>E-mail Alerts Setup</b> E-mail Setup Reply Address	Specify a reply address in the e-mail. <b>Note:</b> This menu item appears only in some printer models.
<b>E-mail Alerts Setup</b> E-mail Setup Always use SMTP default Reply Address Off* On	Use the SMTP default Reply Address. <b>Note:</b> This menu item appears only in some printer models.
<b>E-mail Alerts Setup</b> E-mail Setup Use SSL/TLS Disabled* Negotiate Required	Send an e-mail using an encrypted link. <b>Note:</b> This menu item appears only in some printer models.
<b>E-mail Alerts Setup</b> E-mail Setup Require Trusted Certificate On* Off	Require a trusted certificate when accessing the SMTP server. <b>Note:</b> This menu item appears only in some printer models.
<b>Note:</b> An asterisk (*) next to a value indicates the factory default setting.	

Menu item	Description
<b>E-mail Alerts Setup</b> E-mail Setup SMTP Server Authentication No authentication required* Login / Plain NTLM CRAM-MD5 Digest-MD5 Kerberos 5	Set the authentication type for the SMTP server. <b>Note:</b> This menu item appears only in some printer models.
<b>E-mail Alerts Setup</b> E-mail Setup Device-Initiated E-mail None* Use Device SMTP Credentials	Set whether credentials are required for device-initiated e-mails. <b>Note:</b> This menu item appears only in some printer models.
<b>E-mail Alerts Setup</b> E-mail Setup User-Initiated E-mail None Use Device SMTP Credentials Use Session User ID and Password Use Session E-mail address and Password* Prompt user	Set whether credentials are required for user-initiated e-mails. <b>Note:</b> This menu item appears only in some printer models.
<b>E-mail Alerts Setup</b> E-mail Setup Use Active Directory Device Credentials Off On*	Enable user credentials and group designations to connect to the SMTP server. <b>Note:</b> This menu item appears only in some printer models.
<b>E-mail Alerts Setup</b> E-mail Setup Device Userid	Specify the user ID to connect to the SMTP server. <b>Note:</b> This menu item appears only in some printer models.
<b>E-mail Alerts Setup</b> E-mail Setup Device Password	Specify the password to connect to the SMTP server. <b>Note:</b> This menu item appears only in some printer models.
<b>E-mail Alerts Setup</b> E-mail Setup Kerberos 5 REALM	Specify the realm for the Kerberos 5 authentication protocol. <b>Note:</b> This menu item appears only in some printer models.
<b>E-mail Alerts Setup</b> E-mail Setup NTLM Domain	Specify the domain name for the NTLM security protocol. <b>Note:</b> This menu item appears only in some printer models.

**Note:** An asterisk (\*) next to a value indicates the factory default setting.

Menu item	Description
<p><b>E-mail Alerts Setup</b>                      E-mail Setup                      Disable “SMTP server not set up” error                      Off*                      No</p>	<p>Disable an SMTP setup error message to appear on the display.  <b>Note:</b> This menu item appears only in some printer models.</p>
<p><b>Error Prevention</b>                      Jam Assist                      Off                      On*</p>	<p>Set the printer to flush blank pages or pages with partial prints automatically after a jammed page has been cleared.</p>
<p><b>Error Prevention</b>                      Auto Continue                      Off                      On* (5 seconds)</p>	<p>Let the printer continue processing or printing a job automatically after clearing certain printer conditions that require user intervention.</p>
<p><b>Error Prevention</b>                      Auto Reboot                      Auto Reboot                      Reboot when idle                      Reboot always*                      Reboot never</p>	<p>Set the printer to restart when an error occurs.</p>
<p><b>Error Prevention</b>                      Auto Reboot                      Max Auto Reboots                      1–20 (2*)</p>	<p>Set the number of automatic reboots that the printer can perform.</p>
<p><b>Error Prevention</b>                      Auto Reboot                      Auto Reboot Window                      1–525600 (720*)</p>	<p>Set the number of seconds before the printer performs an automatic reboot.</p>
<p><b>Error Prevention</b>                      Auto Reboot                      Auto Reboot Counter</p>	<p>Show a read-only information of the reboot counter.</p>
<p><b>Error Prevention</b>                      Auto Reboot                      Reset Auto Reboot Counter                      Cancel                      Continue</p>	<p>Reset Auto Reboot Counter.  <b>Note:</b> This menu item appears only in some printer models.</p>
<p><b>Error Prevention</b>                      Display Short Paper Error                      On                      Auto-clear*</p>	<p>Set the printer to show a message when a short paper error occurs.  <b>Note:</b> Short paper refers to the size of the paper loaded.</p>
<p><b>Note:</b> An asterisk (*) next to a value indicates the factory default setting.</p>	

Menu item	Description
<b>Error Prevention</b> Page Protect Off* On	Set the printer to process the entire page into the memory before printing it.
<b>Jam Content Recovery</b> Jam Recovery Off On Auto*	Set the printer to reprint jammed pages.
<b>Note:</b> An asterisk (*) next to a value indicates the factory default setting.	

## Power Management

Menu item	Description
<b>Sleep Mode Profile</b> Print With Display Off Display on when printing Allow printing with display off*	Allow printing with the display turned off.
<b>Timeouts</b> Sleep Mode 1–120 minutes (15*)	Set the idle time before the printer begins operating in Sleep mode.
<b>Timeouts</b> Hibernate Timeout Disabled 1 hour 2 hours 3 hours 6 hours 1 day 2 days 3 days* 1 week 2 weeks 1 month	Set the time before the printer enters Hibernate mode.
<b>Timeouts</b> Hibernate Timeout on Connection Hibernate Do Not Hibernate*	Set the printer to Hibernate mode even when an active Ethernet connection exists.
<b>Note:</b> An asterisk (*) next to a value indicates the factory default setting.	

Menu item	Description
<b>Eco-Mode</b> Off* Energy Energy/Paper Paper	Minimize the use of energy, paper, or specialty media. <b>Note:</b> Setting Eco-Mode to Energy or Paper may affect printer performance, but not print quality.
<b>Schedule Power Modes</b> Schedules	Schedule the printer when to enter Sleep or Hibernate mode. <b>Note:</b> This menu item appears only in some printer models.
<b>Note:</b> An asterisk (*) next to a value indicates the factory default setting.	

### Information Sent to Lexmark

Menu item	Description
<b>Information Sent to Lexmark</b> Supplies and Page Usage (Anonymous) Device Performance (Anonymous) Device Interaction (Anonymous) None of the Above	Send printer usage and performance information to Lexmark. <b>Note:</b> Information Send Time and User Information - Level appear only when you select any of the settings in Information Sent to Lexmark, except None of the Above.
<b>Information Send Time</b> Start Time Stop Time	
<b>User Information - Level</b> Anonymous Session Information Only* Session Information with Generic User Information Session Information with Actual User IDs	

### Accessibility

**Note:** This menu appears only in some printer models.

Menu item	Description
<b>Duplicate Key Strike Interval</b> 0–5 (0*)	Set the interval in seconds during which the printer ignores duplicate key presses on an attached keyboard.
<b>Key Repeat Initial Delay</b> 0.25–5 (1*)	Set the initial length of delay in seconds before a repeating key starts repeating. <b>Note:</b> This menu item appears only when a keyboard is attached to the printer.
<b>Note:</b> An asterisk (*) next to a value indicates the factory default setting.	

Menu item	Description
<b>Key Repeat Rate</b> 0.5–30 (30*)	Set the number of presses per second for a repeating key. <b>Note:</b> This menu item appears only when a keyboard is attached to the printer.
<b>Prolong Screen Timeout</b> Off* On	Let the user remain in the same location and reset the Screen Timeout timer when it expires instead of returning to the home screen.
<b>Headphone Volume</b> 1–10 (5*)	Adjust the headphone volume. <b>Note:</b> This menu item appears only when a headphone is attached to the printer.
<b>Enable Voice Guidance When Headphone Is Attached</b> Off* On	Enable Voice Guidance when a headphone is attached to the printer.
<b>Speak Passwords/PINs</b> Off* On	Set the printer to read out loud passwords or personal identification numbers. <b>Note:</b> This menu item appears only when a headphone or a speaker is attached to the printer.
<b>Speech Rate</b> Very Slow Slow Normal* Fast Faster Very Fast Rapid Very Rapid Fastest	Set the Voice Guidance speech rate. <b>Note:</b> This menu item appears only when a headphone or a speaker is attached to the printer.
<b>Note:</b> An asterisk (*) next to a value indicates the factory default setting.	

## Restore Factory Defaults

Menu item	Description
<b>Restore Settings</b> Restore all settings Restore printer settings Restore network settings Restore app settings	Restore the printer factory default settings. <b>Note:</b> Restore app settings appears only in some printer models.

## Maintenance

### Config Menu

Menu item	Description
<b>USB Configuration</b> USB PnP 1* 2	Change the USB driver mode of the printer to improve its compatibility with a personal computer.
<b>USB Configuration</b> USB Speed Full Auto*	Set the USB port to run at full speed and disable its high-speed capabilities.
<b>Tray Configuration</b> Tray Linking Automatic* Off	Set the printer to link the trays that have the same paper type and paper size settings.
<b>Tray Configuration</b> Show Tray Insert Message Off Only for unknown sizes* Always	Set the printer to show the <b>Tray Insert</b> message.
<b>Tray Configuration</b> A5 Loading Short Edge* Long Edge	Specify the page orientation when loading for A5 paper size.
<b>Tray Configuration</b> Paper Prompts Auto* Multipurpose Feeder Manual Paper Envelope Prompts Auto* Multipurpose Feeder Manual Envelope	Set the paper source that the user will fill when a prompt to load paper or envelope appears.  <b>Note:</b> For Multipurpose Feeder to appear, set Configure MP to Cassette from the Paper menu.
<b>Tray Configuration</b> Action for Prompts Prompt user* Continue Use current	Set the printer to resolve paper- or envelope-related change prompts.
<b>Note:</b> An asterisk (*) next to a value indicates the factory default setting.	



Menu item	Description
<b>Reports</b> Menu Settings Page Event Log Event Log Summary HealthCheck Statistics	Print reports about printer menu settings, printer events, and event logs.
<b>Supply Usage And Counters</b> Clear Supply Usage History Reset Black Cartridge Counter Reset Black Imaging Unit Counter Reset Black Developer Unit Counter Reset Maintenance Counter	Reset the supply page counter or view the total printed pages.
<b>Printer Emulations</b> PPDS Emulation Off* On	Set the printer to recognize and use the PPDS data stream.
<b>Print Configuration</b> Font Sharpening 0–150 (24*)	Set a text point-size value below which the high-frequency screens are used when printing font data. For example, if the value is 24, then all fonts sized 24 points or less use the high-frequency screens.
<b>Print Configuration</b> Print Density 1–5 (3*)	Adjust the toner density when printing or copying documents.
<b>Device Operations</b> Quiet Mode Off* On	Set the amount of noise that the printer produces. <b>Note:</b> Enabling this setting slows the printer performance.
<b>Device Operations</b> Safe Mode Off* On	Set the printer to operate in a special mode, in which it attempts to continue offering as much functionality as possible, despite known issues. For example, when set to On, and the duplex motor is nonfunctional, the printer performs one-sided printing of the documents even if the job is two-sided printing.
<b>Device Operations</b> Clear Custom Status Off On*	Erase user-defined strings for the Default or Alternate custom messages.
<b>Device Operations</b> Clear all remotely-installed messages	Erase messages that were remotely installed.
<b>Device Operations</b> Automatically Display Error Screens On* Off	Show existing error messages on the display after the printer remains inactive on the home screen for a length of time equal to the Screen Timeout setting.
<b>Note:</b> An asterisk (*) next to a value indicates the factory default setting.	

Menu item	Description
<b>Device Operations</b> Custom Supply Levels Off* On	Let <i>printservice</i> read and edit values from the Embedded Web Server.
<b>Note:</b> An asterisk (*) next to a value indicates the factory default setting.	

### Out of Service Erase

Menu item	Description
<b>Out of Service Erase</b> Memory Last Sanitized Hard Disk Last Sanitized	Show information on when the printer memory or hard disk was last sanitized.  <b>Note:</b> Hard Disk Last Sanitized appears only in printers with a hard disk installed.
<b>Out of Service Erase</b> Sanitize all information on nonvolatile memory Sanitize all information on hard disk Erase all printer and network settings	Clear all settings and applications that are stored in the printer memory or hard disk.  <b>Note:</b> Sanitize all information on hard disk appears only in printers with a hard disk installed.

### Visible Home Screen Icons

**Note:** This menu appears only in some printer models.

Menu	Description
Status/Supplies Job Queue Change Language Address Book Bookmarks Held Jobs USB App Profiles Display Customization Eco-Settings	Specify which icons to show on the home screen.

### About this Printer

Menu item	Description
<b>Asset Tag</b>	Show the serial number of the printer.
<b>Printer's Location</b>	Identify the printer location. Maximum length is 63 characters.
<b>Contact</b>	Personalize the printer name. Maximum length is 63 characters.
<b>Export Configuration File to USB</b>	Export configuration files to a flash drive.

Menu item	Description
<b>Export Compressed Logs to USB</b>	Export compressed log files to a flash drive.

# Print

## Layout

Menu item	Description
<b>Sides</b> 1-sided* 2-sided	Specify whether to print on one side or two sides of the paper.
<b>Flip Style</b> Long Edge* Short Edge	Determine which side of the paper (long edge or short edge) is bound when performing two-sided printing.  <b>Note:</b> Depending on the option selected, the printer automatically offsets each printed information of the page to bind the job correctly.
<b>Blank Pages</b> Print Do Not Print*	Print blank pages that are included in a print job.
<b>Collate</b> Off [1,1,1,2,2,2]* On [1,2,1,2,1,2]	Keep the pages of a print job stacked in sequence, particularly when printing multiple copies of the job.
<b>Separator Sheets</b> None* Between Copies Between Jobs Between Pages	Insert blank separator sheets when printing.
<b>Separator Sheet Source</b> Tray [x] (1*) Multipurpose Feeder	Specify the paper source for the separator sheet.  <b>Note:</b> The multipurpose feeder is available only in some printer models.
<b>Pages per Side</b> Off* 2 pages per side 3 pages per side 4 pages per side 6 pages per side 9 pages per side 12 pages per side 16 pages per side	Print multiple page images on one side of a sheet of paper.

**Note:** An asterisk (\*) next to a value indicates the factory default setting.

Menu item	Description
<b>Pages per Side Ordering</b> Horizontal* Reverse Horizontal Vertical Reverse Vertical	Specify the positioning of multiple page images when using Pages per Side. <b>Note:</b> The positioning depends on the number of page images and their page orientation.
<b>Pages per Side Orientation</b> Auto* Landscape Portrait	Specify the orientation of a multiple-page document when using Pages per Side.
<b>Pages per Side Border</b> None* Solid	Print a border around each page image when using Pages per Side.
<b>Copies</b> 1–9999 (1*)	Specify the number of copies for each print job.
<b>Print Area</b> Normal* Fit to page Whole Page	Set the printable area on a sheet of paper.
<b>Note:</b> An asterisk (*) next to a value indicates the factory default setting.	

## Setup

Menu item	Description
<b>Printer Language</b> PCL Emulation PS Emulation*	Set the printer language. <b>Note:</b> Setting a printer language default does not prevent a software program from sending print jobs that use another printer language.
<b>Job Waiting</b> Off* On	Preserve print jobs requiring supplies so that jobs not requiring the missing supplies can print. <b>Note:</b> This menu item appears only when a printer hard disk is installed.
<b>Job Hold Timeout</b> 0–255 (30*)	Set the time in seconds that the printer waits for user intervention before it holds jobs that require unavailable resources and continues to print other jobs in the print queue. <b>Note:</b> This menu item appears only when a printer hard disk is installed.
<b>Download Target</b> RAM* Disk	Specify where to save all permanent resources, such as fonts and macros, that have been downloaded to the printer. <b>Note:</b> This menu item appears only when a printer hard disk is installed.
<b>Note:</b> An asterisk (*) next to a value indicates the factory default setting.	

Menu item	Description
<b>Resource Save</b> Off* On	Determine what the printer does with downloaded resources, such as fonts and macros, when it receives a job that requires more than the available memory.  <b>Notes:</b> <ul style="list-style-type: none"> <li>• When set to Off, the printer retains downloaded resources only until memory is needed. Resources associated with the inactive printer language are deleted.</li> <li>• When set to On, the printer preserves all the permanent downloaded resources across all language switches. When necessary, the printer shows memory full messages instead of deleting permanent resources.</li> </ul>
<b>Print All Order</b> Alphabetical* Newest First Oldest First	Specify the order in which held and confidential jobs are printed when Print All is selected.  <b>Note:</b> This menu item appears only when a printer hard disk is installed.
<b>Note:</b> An asterisk (*) next to a value indicates the factory default setting.	

## Quality

Menu item	Description
<b>Print Resolution</b> 300 dpi 600 dpi* 1200 dpi 1200 Image Q 2400 Image Q	Set the resolution for the text and images on the printed output.  <b>Note:</b> Resolution is determined in dots per inch or image quality.
<b>Pixel Boost</b> Off* Fonts Horizontally Vertically Both directions Isolated	Enable more pixels to print in clusters for clarity, in order to enhance text and images.
<b>Toner Darkness</b> 1–10 (8*)	Determine the lightness or darkness of text images.
<b>Halftone</b> Normal* Detail	Enhance the printed output to have smoother lines with sharper edges.
<b>Brightness</b> -6 to 6 (0*)	Adjust the brightness of the printed output.
<b>Note:</b> An asterisk (*) next to a value indicates the factory default setting.	

Menu item	Description
<b>Contrast</b> 0 to 5 (0*)	Adjust the contrast of the printed output.
<b>Gray Correction</b> Auto* Off	Adjust the contrast enhancement applied to images.
<b>Note:</b> An asterisk (*) next to a value indicates the factory default setting.	

## Job Accounting

**Note:** This menu appears only when a printer hard disk is installed.

Menu item	Description
<b>Job Accounting</b> Off* On	Set the printer to create a log of the print jobs that it receives.
<b>Accounting Log Frequency</b> Daily Weekly Monthly*	Specify how often the printer creates a log file.
<b>Log Action at End of Frequency</b> None* E-mail Current Log E-mail & Delete Current Log Post Current Log Post & Delete Current Log	Specify how the printer responds when the frequency threshold expires. <b>Note:</b> The value defined in Accounting Log Frequency determines when this action is triggered.
<b>Log Near Full Level</b> Off* On	Specify the maximum size of the log file before the printer executes the Log Action at Near Full.
<b>Log Action at Near Full</b> None* E-mail Current Log E-mail & Delete Current Log E-mail & Delete Oldest Log Post Current Log Post & Delete Current Log Post & Delete Oldest Log Delete Current Log Delete Oldest Log Delete All But Current Delete All Logs	Specify how the printer responds when the hard disk is nearly full. <b>Note:</b> The value defined in Log Near Full Level determines when this action is triggered.
<b>Note:</b> An asterisk (*) next to a value indicates the factory default setting.	

Menu item	Description
<b>Log Action at Full</b> None* E-mail & Delete Current Log E-mail & Delete Oldest Log Post & Delete Current Log Post & Delete Oldest Log Delete Current Log Delete Oldest Log Delete All But Current Delete All Logs	Specify how the printer responds when disk usage reaches the maximum limit (100MB).
<b>URL to Post Log</b>	Specify where the printer posts job accounting logs.
<b>E-mail Address to Send Logs</b>	Specify the e-mail address to which the printer sends job accounting logs.
<b>Log File Prefix</b>	Specify the prefix for the log file name.  <b>Note:</b> The current host name defined in the TCP/IP menu is used as the default log file prefix.
<b>Note:</b> An asterisk (*) next to a value indicates the factory default setting.	

## XPS

Menu item	Description
<b>Print Error Pages</b> Off* On	Print a test page that contains information on errors, including XML markup errors.
<b>Minimum Line Width</b> 1–30 (2*)	Set the minimum stroke width.  <b>Notes:</b> <ul style="list-style-type: none"> <li>Jobs printed in 1200 dpi use the value directly.</li> <li>Jobs printed in 4800 CQ use half the value.</li> </ul>
<b>Note:</b> An asterisk (*) next to a value indicates the factory default setting.	

## PDF

Menu item	Description
<b>Scale to Fit</b> Off* On	Scale the page content to fit the selected paper size.
<b>Annotations</b> Print Do Not Print*	Specify whether to print annotations in the PDF.
<b>Note:</b> An asterisk (*) next to a value indicates the factory default setting.	

## PostScript

Menu item	Description
<b>Print PS Error</b> Off* On	Print a page that contains the PostScript error. <b>Note:</b> When an error occurs, processing of the job stops, the printer prints an error message, and the rest of the print job is flushed.
<b>Lock PS Startup Mode</b> Off* On	Disable the PostScript SysStart file.
<b>Image Smoothing</b> Off* On	Enhance the contrast and sharpness of low-resolution images. <b>Note:</b> This setting has no effect on images with a resolution of 300 dpi or higher.
<b>Wait Timeout</b> Disabled 15-65535 (40*)	Set the printer to wait for more data before canceling a print job.
<b>Note:</b> An asterisk (*) next to a value indicates the factory default setting.	

## PCL

Menu item	Description
<b>Font Source</b> Resident* Disk Flash All	Choose the source which contains the default font selection. <b>Notes:</b> <ul style="list-style-type: none"> <li>• Flash and Disk appear only in some printer models.</li> <li>• For Flash and Disk to appear, make sure that they are not read- or write-protected.</li> </ul>
<b>Font Name</b> [List of available fonts] (Courier*)	Select a font from the specified font source.
<b>Symbol Set</b> [List of available symbol set] (10U PC-8*)	Specify the symbol set for each font name. <b>Note:</b> A symbol set is a set of alphabetic and numeric characters, punctuation, and special symbols. Symbol sets support the different languages or specific programs such as math symbols for scientific text.
<b>Pitch</b> 0.08–100 (10*)	Specify the pitch for fixed or monospaced fonts. <b>Note:</b> Pitch refers to the number of fixed-space characters in a horizontal inch of type.
<b>Orientation</b> Portrait* Landscape	Specify the orientation of text and graphics on the page.
<b>Note:</b> An asterisk (*) next to a value indicates the factory default setting.	



Menu item	Description
<b>Lines per Page</b> 1–255	Specify the number of lines of text for each page printed through the PCL® datastream.  <b>Notes:</b> <ul style="list-style-type: none"> <li>This menu item activates vertical escapement that causes the selected number of requested lines to print between the default margins of the page.</li> <li>60 is the U.S. factory default setting. 64 is the international factory default setting.</li> </ul>
<b>PCL5 Minimum Line Width</b> 1–30 (2*)	Set the initial minimum stroke width.  <b>Notes:</b> <ul style="list-style-type: none"> <li>Jobs printed in 1200 dpi use the value directly.</li> <li>Jobs printed in 4800CQ use half the value.</li> </ul>
<b>PCLXL Minimum Line Width</b> 1–30 (2*)	
<b>A4 Width</b> 198 mm* 203 mm	Set the width of the logical page on A4-size paper.  <b>Note:</b> Logical page is the space on the physical page where data is printed.
<b>Auto CR after LF</b> Off* On	Set the printer to perform a carriage return after a line feed control command.  <b>Note:</b> Carriage return is a mechanism that commands the printer to move the position of the cursor to the first position on the same line.
<b>Auto LF after CR</b> Off* On	Set the printer to perform a line feed after a carriage return control command.
<b>Tray Renumber</b> Assign MP Feeder Assign Tray [x] Assign Manual Paper Assign Manual Envelope	Configure the printer to work with a different print driver or custom application that uses a different set of source assignments to request a given paper source.  Choose from the following options: Off*—The printer uses the factory default paper source assignments. None—The paper source ignores the Select Paper Feed command. 0–199—Select a numeric value to assign a custom value to a paper source.  <b>Note:</b> The multipurpose feeder is available only in some printer models.
<b>Tray Renumber</b> View Factory Defaults	Show the factory default value assigned for each paper source.
<b>Tray Renumber</b> Restore Defaults	Restore the tray renumber values to their factory defaults.
<b>Print Timeout</b> Off On* [90]	Set the printer to end a print job after it has been idle for the specified amount of time in seconds.
<b>Note:</b> An asterisk (*) next to a value indicates the factory default setting.	

## HTML

Menu item	Description
<b>Font Name</b> [List of fonts] (Times*)	Set the font to use for HTML documents.
<b>Font Size</b> 1–255 (12*)	Set the font size to use for HTML documents.
<b>Scale</b> 1–400% (100*)	Scale HTML documents.
<b>Orientation</b> Portrait* Landscape	Set the page orientation for HTML documents.
<b>Margin Size</b> 8–255 mm (19*)	Set the page margin for HTML documents.
<b>Backgrounds</b> Do Not Print Print*	Print background information or graphics for HTML documents.
<b>Note:</b> An asterisk (*) next to a value indicates the factory default setting.	

## Image

Menu item	Description
<b>Auto Fit</b> Off On*	Select the best available paper size and orientation setting for an image. <b>Note:</b> When set to On, this menu item overrides the scaling and orientation settings for the image.
<b>Invert</b> Off* On	Invert bitonal monochrome images. <b>Note:</b> This menu item does not apply to GIF or JPEG image formats.
<b>Scaling</b> Best Fit* Anchor Top Left Anchor Center Fit Height/Width Fit Height Fit Width	Adjust the image to fit the printable area. <b>Note:</b> When Auto Fit is set to On, Scaling is automatically set to Best Fit.
<b>Orientation</b> Portrait* Landscape Reverse Portrait Reverse Landscape	Specify the orientation of text and graphics on the page.
<b>Note:</b> An asterisk (*) next to a value indicates the factory default setting.	

# Paper

## Tray Configuration

Menu item	Description
<b>Default Source</b> Tray [x] (1*) Multipurpose Feeder Manual Paper Manual Envelope	Set the paper source for all print jobs.  <b>Note:</b> Multipurpose Feeder only appears when Configure MP is set to Cassette.
<b>Paper Size/Type</b> Tray [x] Multipurpose Feeder Manual Paper Manual Envelope	Specify the paper size or paper type loaded in each paper source.
<b>Substitute Size</b> Off Letter/A4 All Listed*	Set the printer to substitute a specified paper size if the requested size is not loaded in any paper source.  <b>Notes:</b> <ul style="list-style-type: none"> <li>• Off prompts the user to load the required paper size.</li> <li>• Letter/A4 prints A4-size document on letter when loading letter and letter-size jobs on A4 paper size when loading letter.</li> <li>• All Listed substitutes Letter/A4.</li> </ul>
<b>Configure MP</b> Cassette* Manual First	Set the printer when to pick paper loaded in the multipurpose feeder.  <b>Notes:</b> <ul style="list-style-type: none"> <li>• When set to Cassette, the printer treats the multipurpose feeder like a tray.</li> <li>• When set to Manual, the printer treats the multipurpose feeder like a manual feeder.</li> <li>• When set to First, the printer picks paper from the multipurpose feeder until it is empty, regardless of the required paper source or paper size.</li> </ul>
<b>Note:</b> An asterisk (*) next to a value indicates the factory default setting.	

## Media Configuration

### Universal Setup

Menu item	Description
<b>Units of Measure</b> Inches Millimeters	Specify the unit of measurement for the universal paper.  <b>Note:</b> Inches is the U.S. factory default setting. Millimeters is the international factory default setting.
<b>Note:</b> An asterisk (*) next to a value indicates the factory default setting.	

Menu item	Description
<b>Portrait Width</b> 3–14.17 inches (8.50*) 76–359.91 mm (216*)	Set the portrait width of the universal paper.
<b>Portrait Height</b> 3–14.17 inches (14*) 76–359.91 mm (356*)	Set the portrait height of the universal paper.
<b>Feed Direction</b> Short Edge* Long Edge	Set the printer to pick paper from the short edge or long edge direction.  <b>Note:</b> Long Edge appears only when the longest edge is shorter than the maximum width supported.
<b>Note:</b> An asterisk (*) next to a value indicates the factory default setting.	

### Media Types

Menu item	Description
Plain Card Stock Transparency Recycled Labels Vinyl Labels Bond Envelope Rough Envelope Letterhead Preprinted Colored Paper Light Heavy Rough/Cotton Custom Type [x]	Specify the texture, weight, and orientation of the paper loaded.

## USB Drive

### Flash Drive Print

Menu item	Description
<b>Number of Copies</b> 1–9999 (1*)	Set the number of copies.
<b>Note:</b> An asterisk (*) next to a value indicates the factory default setting.	

Menu item	Description
<b>Paper Source</b> Tray [x] (1*) Multipurpose Feeder Manual Paper Manual Envelope	Set the paper source for the print job.
<b>Collate</b> (1,1)(2,2,2) (1,2,3)(1,2,3)*	Print multiple copies in sequence.
<b>Sides</b> 1-Sided* 2-Sided	Specify whether to print on one side or two sides of the paper.
<b>Flip Style</b> Long Edge* Short Edge	Determine which side of the paper (long edge or short edge) is bound when performing two-sided printing.  <b>Note:</b> Depending on the option selected, the printer automatically offsets each printed information of the page to bind the job correctly.
<b>Pages per Side</b> Off* [n] pages per side	Print multiple page images on one side of a sheet of paper.
<b>Pages per Side Ordering</b> Horizontal* Reverse Horizontal Reverse Vertical Vertical	Specify the positioning of multiple page images when using Pages per Side.  <b>Note:</b> The positioning depends on the number of page images and their page orientation.
<b>Pages per Side Orientation</b> Auto* Landscape Portrait	Specify the orientation of a multiple-page document when using Pages per Side.
<b>Pages per Side Border</b> None* Solid	Print a border around each page image when using Pages per Side.
<b>Separator Sheets</b> Off* Between Copies Between Jobs Between Pages	Specify whether to insert blank separator sheets when printing.
<b>Separator Sheet Source</b> Tray [x] (1*) Multipurpose Feeder	Specify the paper source for the separator sheet.  <b>Note:</b> For Multipurpose Feeder to appear, set Configure MP to Cassette from the Paper menu.
<b>Blank Pages</b> Do Not Print* Print	Specify whether to print blank pages in a print job.
<b>Note:</b> An asterisk (*) next to a value indicates the factory default setting.	

## Network/Ports

### Network Overview

Menu item	Description
<b>Active Adapter</b> Auto* Standard Network	Specify how a network is connected.
<b>Network Status</b>	Show the connection status of the printer network.
<b>Display Network Status on Printer</b> On* Off	Show the network status on the display.
<b>Speed, Duplex</b>	Show the speed of the currently active network card.
<b>IPv4</b>	Show the IPv4 address.
<b>All IPv6 Addresses</b>	Show all IPv6 addresses.
<b>Reset Print Server</b>	Reset all active network connections to the printer. <b>Note:</b> This setting removes all network configuration settings.
<b>Network Job Timeout</b> Off On* (90 seconds)	Set the time before the printer cancels a network print job.
<b>Banner Page</b> Off* On	Print a banner page.
<b>Note:</b> An asterisk (*) next to a value indicates the factory default setting.	

### Wireless

**Note:** This menu is available only in printers connected to a Wi-Fi network or printers that have a wireless network adapter.

Menu item	Description
<b>Setup Using Mobile App</b>	Configure the Wi-Fi connection using Lexmark Mobile Assistant.

Menu item	Description
<b>Setup On Printer Panel</b> Choose Network Add Wi-Fi Network Network Name Network Mode Infrastructure Wireless Security Mode Disabled* WEP WPA2/WPA - Personal WPA2 - Personal 802.1x - RADIUS	Configure the Wi-Fi connection using the control panel. <b>Note:</b> 802.1x - RADIUS can be configured only from the Embedded Web Server.
<b>Wi-Fi Protected Setup</b> WPS Auto Detect Off On* Start Push Button Method Start PIN Method	Establish a Wi-Fi network and enable network security. <b>Notes:</b> <ul style="list-style-type: none"> <li>• WPS Auto Detect appears only when the Wireless Security Mode is set to WEP.</li> <li>• Start Push-Button Method connects the printer to a Wi-Fi network when buttons on both the printer and the access point (wireless router) are pressed within a given time.</li> <li>• Start PIN Method connects the printer to a Wi-Fi network when a PIN on the printer is entered into the wireless settings of the access point.</li> </ul>
<b>Network Mode</b> BSS Type Infrastructure*	Specify the network mode.
<b>Enable Wi-Fi Direct</b> On Off*	Enable Wi-Fi Direct-capable devices to connect directly to the printer.
<b>Compatibility</b> 802.11b/g/n (2.4GHz)* 802.11a/b/g/n/ac (2.4GHz/5GHz) 802.11a/n/ac (5GHz)	Specify the standard for the Wi-Fi network. <b>Note:</b> 802.11a/b/g/n/ac (2.4GHz/5GHz) and 802.11a/n/ac (5GHz) only appear when a Wi-Fi option is installed.
<b>Wireless Security Mode</b> Disabled* WEP WPA2/WPA-Personal WPA2-Personal 802.1x - RADIUS	Set the security mode for connecting the printer to Wi-Fi devices. <b>Note:</b> 802.1x - RADIUS can be configured only from the Embedded Web Server.
<b>WEP Authentication Mode</b> Auto* Open Shared	Set the type of Wireless Encryption Protocol (WEP) for the printer. <b>Note:</b> This menu item appears only when the Wireless Security Mode is set to WEP.
<b>Set WEP Key</b>	Specify a WEP password for secure Wi-Fi connection.

Menu item	Description
<b>WPA2/WPA Personal</b> AES	Enable Wi-Fi security through Wi-Fi Protected Access (WPA). <b>Note:</b> This menu item appears only when the Wireless Security Mode is set to WPA2/WPA-Personal.
<b>Set Pre-Shared Key</b>	Set the password for secure Wi-Fi connection.
<b>WPA2-Personal</b> AES	Enable Wi-Fi security through WPA2. <b>Note:</b> This menu item appears only when the Wireless Security Mode is set to WPA2-Personal.
<b>802.1x Encryption Mode</b> WPA+ WPA2*	Enable Wi-Fi security through 802.1x standard. <b>Notes:</b> <ul style="list-style-type: none"> <li>• This menu item appears only when the Wireless Security Mode is set to 802.1x - RADIUS.</li> <li>• 802.1x - RADIUS can be configured only from the Embedded Web Server.</li> </ul>
<b>IPv4</b> Enable DHCP On* Off Set Static IP Address IP Address Netmask Gateway	Enable and configure IPv4 settings in the printer.
<b>IPv6</b> Enable IPv6 On* Off Enable DHCPv6 On Off* Stateless Address Autoconfiguration On* Off DNS Server Address Manually Assigned IPv6 Address Manually Assigned IPv6 Router Address Prefix All IPv6 Addresses All IPv6 Router Addresses	Enable and configure IPv6 settings in the printer.
<b>Network Address</b> UAA LAA	View the network addresses.



Menu item	Description
<b>PCL SmartSwitch</b> Off On*	Set the printer to switch automatically to PCL emulation when a print job requires it, regardless of the default printer language.  <b>Note:</b> If PCL SmartSwitch is off, then the printer does not examine incoming data and uses the default printer language specified in the Setup menu.
<b>PS SmartSwitch</b> Off On*	Set the printer to switch automatically to PS emulation when a print job requires it, regardless of the default printer language.  <b>Note:</b> If PS SmartSwitch is off, then the printer does not examine incoming data and uses the default printer language specified in the Setup menu.
<b>Job Buffering</b> On Off*	Temporarily store print jobs in the printer hard disk before printing.  <b>Note:</b> This menu item appears only when a hard disk is installed.
<b>Mac Binary PS</b> Auto* On Off	Set the printer to process Macintosh binary PostScript print jobs.  <b>Notes:</b> <ul style="list-style-type: none"> <li>• On processes raw binary PostScript print jobs.</li> <li>• Off filters print jobs using the standard protocol.</li> </ul>

## Ethernet

Menu item	Description
<b>Network Speed</b>	Show the speed of an active network adapter.
<b>IPv4</b> Enable DHCP On* Off	Enable Dynamic Host Configuration Protocol (DHCP).  <b>Note:</b> DHCP is a standard protocol that allows a server to dynamically distribute IP addressing and configuration information to clients.
<b>IPv4</b> Set Static IP Address IP Address Netmask Gateway	Set the static IP address of your printer.
<b>IPv6</b> Enable IPv6 Off On*	Enable IPv6 in the printer.
<b>IPv6</b> Enable DHCPv6 Off* On	Enable DHCPv6 in the printer.
<b>Note:</b> An asterisk (*) next to a value indicates the factory default setting.	

Menu item	Description
<b>IPv6</b> Stateless Address Autoconfiguration Off On*	Set the network adapter to accept the automatic IPv6 address configuration entries provided by a router.
<b>IPv6</b> DNS Server Address	Specify the DNS server address.
<b>IPv6</b> Manually Assigned IPv6 Address	Assign the IPv6 address.
<b>IPv6</b> Manually Assigned IPv6 Router	Assign the IPv6 address.
<b>IPv6</b> Address Prefix 0–128 (64*)	Specify the address prefix.
<b>IPv6</b> All IPv6 Addresses	Show all IPv6 addresses.
<b>IPv6</b> All IPv6 Router Addresses	Show all IPv6 router addresses.
<b>Network Address</b> UAA LAA	Show the printer Media Access Control (MAC) addresses: Locally Administered Address (LAA) and Universally Administered Address (UAA). <b>Note:</b> You can change the printer LAA manually.
<b>PCL SmartSwitch</b> Off On*	Set the printer to switch automatically to PCL emulation when a print job requires it, regardless of the default printer language. <b>Note:</b> If PCL SmartSwitch is off, then the printer does not examine incoming data and uses the default printer language specified in the Setup menu.
<b>PS SmartSwitch</b> Off On*	Set the printer to switch automatically to PS emulation when a print job requires it, regardless of the default printer language. <b>Note:</b> If PS SmartSwitch is off, then the printer does not examine incoming data and uses the default printer language specified in the Setup menu.
<b>Job Buffering</b> Off On*	Temporarily store jobs on the printer hard disk before printing. <b>Notes:</b> <ul style="list-style-type: none"> <li>• This menu item appears only when a hard disk is installed.</li> <li>• This menu item appears only in some printer models.</li> </ul>
<b>Mac Binary PS</b> Auto* On Off	Set the printer to process Macintosh binary PostScript print jobs. <b>Notes:</b> <ul style="list-style-type: none"> <li>• On processes raw binary PostScript print jobs.</li> <li>• Off filters print jobs using the standard protocol.</li> </ul>
<b>Note:</b> An asterisk (*) next to a value indicates the factory default setting.	

Menu item	Description
<b>Energy Efficient Ethernet</b> Off On*	Reduce power consumption when the printer does not receive data from the Ethernet network.
<b>Note:</b> An asterisk (*) next to a value indicates the factory default setting.	

## TCP/IP

**Note:** This menu appears only in network printers or printers attached to print servers.

Menu item	Description
<b>Set Hostname</b>	Set the current TCP/IP host name.
<b>Domain Name</b>	Set the domain name. <b>Note:</b> This menu item appears only in some printer models.
<b>Allow DHCP/BOOTP to update NTP server</b> Off On*	Allow the DHCP and BOOTP clients to update the NTP settings of the printer.
<b>Zero Configuration Name</b>	Specify a service name for the zero configuration network. <b>Note:</b> This menu item appears only in some printer models.
<b>Enable Auto IP</b> Off On*	Assign an IP address automatically.
<b>DNS Server Address</b>	Specify the current Domain Name System (DNS) server address.
<b>Backup DNS Server Address</b>	Specify the backup DNS server addresses.
<b>Backup DNS Server Address 2</b>	
<b>Backup DNS Server Address 3</b>	
<b>Domain Search Order</b>	Specify a list of domain names to locate the printer and its resources that reside in different domains on the network. <b>Note:</b> This menu item appears only in some printer models.
<b>Enable DDNS</b> Off On*	Update the Dynamic DNS settings.
<b>DDNS TTL</b>	Specify the current DDNS settings.
<b>Default TTL</b>	
<b>DDNS Refresh Time</b>	
<b>Enable mDNS</b> Off On*	Update multicast DNS settings.
<b>Note:</b> An asterisk (*) next to a value indicates the factory default setting.	

Menu item	Description
<b>WINS Server Address</b>	Specify a server address for Windows Internet Name Service (WINS).
<b>Enable BOOTP</b> Off* On	Allow the BOOTP to assign a printer IP address.
<b>Restricted Server List</b>	Specify an IP address for the TCP connections.  <b>Notes:</b> <ul style="list-style-type: none"> <li>• Use a comma to separate each IP address.</li> <li>• You can add up to 50 IP addresses.</li> </ul>
<b>Restricted Server List Options</b> Block All Ports* Block Printing Only Block Printing and HTTP Only	Specify how the IP addresses in the list can access the printer functionality.
<b>MTU</b>	Specify a maximum transmission unit (MTU) parameter for the TCP connections.
<b>Raw Print Port</b> 1–65535 (9100*)	Specify a raw port number for printers connected on a network.
<b>Outbound Traffic Maximum Speed</b> Off* On	Enable the printer maximum transfer rate.
<b>Enhanced TLS Security</b> Off* On	Enhance printer privacy and data integrity.
<b>Note:</b> An asterisk (*) next to a value indicates the factory default setting.	

## SNMP

**Note:** This menu appears only in network printers or printers that are attached to print servers.

Menu item	Description
<b>SNMP Versions 1 and 2c</b> Enabled Off On* Allow SNMP Set Off On* Enable PPM MIB Off On* SNMP Community	Configure Simple Network Management Protocol (SNMP) versions 1 and 2c to install print drivers and applications.
<b>Note:</b> An asterisk (*) next to a value indicates the factory default setting.	

Menu item	Description
<p><b>SNMP Version 3</b></p> <ul style="list-style-type: none"> <li>Enabled</li> <li>Off</li> <li>On*</li> <li>Set Read/Write Credentials                             <ul style="list-style-type: none"> <li>User Name</li> <li>Password</li> </ul> </li> <li>Set Read-only Credentials                             <ul style="list-style-type: none"> <li>User Name</li> <li>Password</li> </ul> </li> <li>Authentication Hash                             <ul style="list-style-type: none"> <li>MD5</li> <li>SHA1*</li> </ul> </li> <li>Minimum Authentication Level                             <ul style="list-style-type: none"> <li>No Authentication, No Privacy</li> <li>Authentication, No Privacy</li> <li>Authentication, Privacy*</li> </ul> </li> <li>Privacy Algorithm                             <ul style="list-style-type: none"> <li>DES</li> <li>AES-128*</li> </ul> </li> </ul>	<p>Configure SNMP version 3 to install and update the printer security.</p>
<p><b>Note:</b> An asterisk (*) next to a value indicates the factory default setting.</p>	

## IPSec

**Note:** This menu appears only in network printers or printers that are attached to print servers.

Menu item	Description
<p><b>Enable IPSec</b></p> <ul style="list-style-type: none"> <li>Off*</li> <li>On</li> </ul>	<p>Enable Internet Protocol Security (IPSec).</p>
<p><b>Base Configuration</b></p> <ul style="list-style-type: none"> <li>Default*</li> <li>Compatibility</li> <li>Secure</li> </ul>	<p>Set the IPSec base configuration.</p> <p><b>Note:</b> This menu item appears only when Enable IPSec is set to On.</p>
<p><b>IPSec Device Certificate</b></p>	<p>Specify an IPSec certificate.</p> <p><b>Note:</b> This menu item appears only when Base Configuration is set to Compatibility.</p>
<p><b>Note:</b> An asterisk (*) next to a value indicates the factory default setting.</p>	

Menu item	Description
<b>Pre-Shared Key Authenticated Connections</b> Host [x] Address Key	Configure the authenticated connections of the printer. <b>Note:</b> These menu items appear only when Enable IPsec is set to On.
<b>Certificate Authenticated Connections</b> Host [x] Address[/subnet] Address[/subnet]	
<b>Note:</b> An asterisk (*) next to a value indicates the factory default setting.	

## 802.1x

**Note:** This menu appears only in network printers or printers that are attached to print servers.

Menu item	Description
<b>Active</b> Off* On	Let the printer join networks that require authentication before allowing access. <b>Note:</b> To configure the settings of this menu item, access the Embedded Web Server.
<b>Note:</b> An asterisk (*) next to a value indicates the factory default setting.	

## LPD Configuration

**Note:** This menu appears only in network printers or printers that are attached to print servers.

Menu item	Description
<b>LPD Timeout</b> 0–65535 seconds (90*)	Set the time-out value to stop the Line Printer Daemon (LPD) server from waiting indefinitely for hung or invalid print jobs.
<b>LPD Banner Page</b> Off* On	Print a banner page for all LPD print jobs. <b>Note:</b> A banner page is the first page of a print job used as a separator of print jobs and to identify the originator of the print job request.
<b>LPD Trailer Page</b> Off* On	Print a trailer page for all LPD print jobs. <b>Note:</b> A trailer page is the last page of a print job.
<b>LPD Carriage Return Conversion</b> Off* On	Enable carriage return conversion. <b>Note:</b> Carriage return is a mechanism that commands the printer to move the position of the cursor to the first position on the same line.
<b>Note:</b> An asterisk (*) next to a value indicates the factory default setting.	

## HTTP/FTP Settings

**Note:** This menu appears only in network printers or printers attached to print servers.

Menu item	Description
<b>Enable HTTP Server</b> Off On*	Access the Embedded Web Server to monitor and manage the printer.
<b>Enable HTTPS</b> Off On*	Configure the Hypertext Transfer Protocol Secure (HTTPS) settings.
<b>Enable FTP/TFTP</b> Off On*	Send files using FTP.
<b>Local Domains</b>	Specify domain names for HTTP and FTP servers. <b>Note:</b> This menu item appears only in some printer models.
<b>HTTP Proxy IP Address</b>	Configure the HTTP and FTP server settings. <b>Note:</b> These menu items appear only in some printer models.
<b>FTP Proxy IP Address</b>	
<b>HTTP Default IP Port</b> 1–65535 (80*)	
<b>HTTPS Device Certificate</b>	
<b>FTP Default IP Port</b> 1–65535 (21*)	
<b>Timeout for HTTP/FTP Requests</b> 1–299 (30*)	Specify the amount of time before the server connection stops.
<b>Retries for HTTP/FTP Requests</b> 1–299 (3*)	Set the number of retries to connect to the HTTP/FTP server.
<b>Note:</b> An asterisk (*) next to a value indicates the factory default setting.	

## ThinPrint

Menu item	Description
<b>Enable ThinPrint</b> Off On*	Print using ThinPrint.
<b>Port Number</b> 4000–4999 (4000*)	Set the port number for the ThinPrint server.
<b>Bandwidth (bits/sec)</b> 100–1000000 (0*)	Set the speed to transmit data in a ThinPrint environment.
<b>Note:</b> An asterisk (*) next to a value indicates the factory default setting.	

Menu item	Description
<b>Packet Size (kbytes)</b> 0–64000 (0*)	Set the packet size for data transmission.
<b>Note:</b> An asterisk (*) next to a value indicates the factory default setting.	

## USB

**Note:** This menu appears only in some printer models.

Menu item	Description
<b>PCL SmartSwitch</b> Off On*	Set the printer to switch to PCL emulation when a print job received through a USB port requires it, regardless of the default printer language. <b>Note:</b> If PCL SmartSwitch is off, then the printer does not examine incoming data and uses the default printer language specified in the Setup menu.
<b>PS SmartSwitch</b> Off On*	Set the printer to switch to PS emulation when a print job received through a USB port requires it, regardless of the default printer language. <b>Note:</b> If PS SmartSwitch is off, then the printer does not examine incoming data and uses the default printer language specified in the Setup menu.
<b>Job Buffering</b> Off* On	Temporarily store jobs on the printer hard disk before printing. <b>Note:</b> This menu item appears only when a hard disk installed.
<b>Mac Binary PS</b> On Auto* Off	Set the printer to process Macintosh binary PostScript print jobs. <b>Notes:</b> <ul style="list-style-type: none"> <li>• When set to On, the printer processes raw binary PostScript print jobs from computers using the Macintosh operating system.</li> <li>• When set to Auto, the printer processes print jobs from computers using either Windows or Macintosh operating systems</li> <li>• When set to Off, the printer filters PostScript print jobs using the standard protocol.</li> </ul>
<b>Enable USB Port</b> Off On*	Enable the standard USB port.
<b>Note:</b> An asterisk (*) next to a value indicates the factory default setting.	

## Google Cloud Print

Menu item	Description
<b>Registration</b> Register	Register the printer to the Google Cloud Print server.
<b>Note:</b> An asterisk (*) next to a value indicates the factory default setting.	



Menu item	Description
<b>Options</b> Enable Google Cloud Print Off On*	Print directly from your Google account.
<b>Options</b> Enable Local Discovery Off On*	Allow the registered user and other users on the same subnet to send jobs to the printer locally.
<b>Options</b> Enable SSL Peer Verification Off On*	Verify authenticity of the peer certificate to connect to your Google account.
<b>Options</b> Always Print As Image Off* On	Set the printer to process PDF files as an image for faster printing.
<b>Note:</b> An asterisk (*) next to a value indicates the factory default setting.	

## Wi-Fi Direct

**Note:** This menu appears only when a direct Wi-Fi network is the active network.

Menu item	Description
<b>SSID</b>	Specify the service set identifier (SSID) of the Wi-Fi network.
<b>Set Preshared Key</b>	Set the preshared key (PSK) to authenticate and validate users on a Wi-Fi connection.
<b>Show PSK on Setup Page</b> Off On*	Show the PSK on the Network Setup Page.
<b>Group Owner IP Address</b>	Specify the IP address of the group owner.
<b>Auto-Accept Push Button Requests</b> Off* On	Accept requests to connect to the network automatically. <b>Note:</b> Accepting clients automatically is not secured.
<b>Note:</b> An asterisk (*) next to a value indicates the factory default setting.	

# Security

## Login Methods

### Manage Permissions

Menu item	Description
<p><b>Function Access</b></p> <ul style="list-style-type: none"> <li>Modify Address Book</li> <li>Create Profiles</li> <li>Manage Bookmarks</li> <li>Flash Drive Print</li> <li>Held Jobs Access</li> <li>User Profiles</li> <li>Cancel Jobs at the Device</li> <li>Change Language</li> <li>Internet Printing Protocol (IPP)</li> <li>B/W Print</li> </ul>	<p>Control access to the printer functions.</p>
<p><b>Administrative Menus</b></p> <ul style="list-style-type: none"> <li>Security Menu</li> <li>Network/Ports Menu</li> <li>Paper Menu</li> <li>Reports Menu</li> <li>Function Configuration Menus</li> <li>Supplies Menu</li> <li>Option Card Menu</li> <li>SE Menu</li> <li>Device Menu</li> </ul>	<p>Control access to the printer menus.</p>
<p><b>Device Management</b></p> <ul style="list-style-type: none"> <li>Remote Management</li> <li>Firmware Updates</li> <li>Apps Configuration</li> <li>Operator Panel Lock</li> <li>Import / Export All Settings</li> <li>Out of Service Erase</li> </ul>	<p>Control access to the printer management options.</p>
<p><b>Apps</b></p> <ul style="list-style-type: none"> <li>New Apps</li> <li>Slideshow</li> <li>Change Wallpaper</li> <li>Screen Saver</li> <li>Eco-Settings</li> </ul>	<p>Control access to the printer applications.</p> <p><b>Note:</b> The list may vary depending on the applications that are enabled from the Embedded Web Server.</p>

### Local Accounts

Menu item	Description
<b>Manage Groups/Permissions</b> Add Group Import Access Controls Function Access Administrative Menus Device Management Apps All Users Import Access Controls Function Access Administrative Menus Device Management Apps Admin	Control group or user access to the printer functions, applications, and security settings.
<b>Add User</b> User Name/Password User Name Password PIN	Create local accounts to manage access to the printer functions.
<b>User Name/Password Accounts</b> Add User	
<b>User Name Accounts</b> Add User	
<b>Password Accounts</b> Add User	
<b>PIN Accounts</b> Add User	

### Schedule USB Devices

Menu item	Description
<b>Schedules</b> Add New Schedule	Schedule access to the USB ports.

## Security Audit Log

Menu item	Description
<b>Enable Audit</b> Off* On	Record the events in the secure audit log and remote syslog.
<b>Enable Remote Syslog</b> Off* On	Send audit logs to a remote server.
<b>Remote Syslog Server</b>	Specify the remote syslog server.
<b>Remote Syslog Port</b> 1–65535 (514*)	Specify the remote syslog port.
<b>Remote Syslog Method</b> Normal UDP* Stunnel	Specify a syslog method to transmit logged events to a remote server.
<b>Remote Syslog Facility</b> 0 - Kernel Messages 1 - User-Level Messages 2 - Mail System 3 - System Daemons 4 - Security/Authorization Messages* 5 - Messages Generated Internally by Syslogs 6 - Line Printer Subsystem 7 - Network News Subsystem 8 - UUCP Subsystem 9 - Clock Daemon 10 - Security/Authorization Messages 11 - FTP Daemon 12 - NTP Subsystem 13 - Log Audit 14 - Log Alert 15 - Clock Daemon 16 - Local Use 0 (local0) 17 - Local Use 1 (local1) 18 - Local Use 2 (local2) 19 - Local Use 3 (local3) 20 - Local Use 4 (local4) 21 - Local Use 5 (local5) 22 - Local Use 6 (local6) 23 - Local Use 7 (local7)	Specify a facility code that the printer uses when sending log events to a remote server.
<b>Note:</b> An asterisk (*) next to a value indicates the factory default setting.	

Menu item	Description
<b>Severity of Events to Log</b> 0 - Emergency 1 - Alert 2 - Critical 3 - Error 4 - Warning* 5 - Notice 6 - Informational 7 - Debug	Specify the priority level cutoff for logging messages and events.
<b>Remote Syslog Non-Logged Events</b> Off* On	Send all events, regardless of severity level, to the remote server.
<b>Admin's E-mail Address</b>	Send e-mail notification of logged events to the administrator.
<b>E-mail Log Cleared Alert</b> Off* On	Send e-mail notification to the administrator when a log entry is deleted.
<b>E-mail Log Wrapped Alert</b> Off* On	Send e-mail notification to the administrator when the log becomes full and begins to overwrite the oldest entries.
<b>Log Full Behavior</b> Wrap Over Older Entries* E-mail Log Then Delete All Entries	Resolve log storage issues when the log fills its allotted memory.
<b>E-mail % Full Alert</b> Off* On	Send e-mail notification to the administrator when the log fills its allotted memory.
<b>% Full Alert Level</b> 1–99 (90*)	
<b>E-mail Log Exported Alert</b> Off* On	Send e-mail notification to the administrator when a log is exported.
<b>E-mail Log Settings Changed Alert</b> Off* On	Send e-mail notification to the administrator when Enable Audit is set.
<b>Log Line Endings</b> LF (\n)* CR (\r) CRLF (\r\n)	Specify how the log file terminates the end of each line.
<b>Note:</b> An asterisk (*) next to a value indicates the factory default setting.	

Menu item	Description
<b>Digitally Sign Exports</b> Off* On	Add a digital signature to each exported log file.
<b>Clear Log</b>	Delete all audit logs.
<b>Export Log</b> Syslog (RFC 5424) Syslog (RFC 3164) CSV	Export a security log to a flash drive.
<b>Note:</b> An asterisk (*) next to a value indicates the factory default setting.	

## Login Restrictions

Menu item	Description
<b>Login failures</b> 1–10 (3*)	Specify the number of failed login attempts before the user gets locked out.
<b>Failure time frame</b> 1–60 minutes (5*)	Specify the time frame between failed login attempts before the user gets locked out.
<b>Lockout time</b> 1–60 minutes (5*)	Specify the lockout duration.
<b>Web Login Timeout</b> 1–120 minutes (10*)	Specify the delay for a remote login before the user is logged off automatically.
<b>Note:</b> An asterisk (*) next to a value indicates the factory default setting.	

## Confidential Print Setup

Menu item	Description
<b>Max Invalid PIN</b> 2–10	Set the number of times an invalid PIN can be entered. <b>Notes:</b> <ul style="list-style-type: none"> <li>• A value of zero turns off this setting.</li> <li>• When the limit is reached, the print jobs for that user name and PIN are deleted.</li> <li>• This menu item appears only when a hard disk is installed.</li> </ul>
<b>Confidential Job Expiration</b> Off* 1 Hour 4 Hours 24 Hours 1 Week	Set the expiration time for confidential print jobs. <b>Notes:</b> <ul style="list-style-type: none"> <li>• If this menu item is changed while confidential print jobs reside in the printer memory or hard disk, then the expiration time for those print jobs does not change to the new default value.</li> <li>• If the printer is turned off, then all confidential jobs held in the printer memory are deleted.</li> </ul>
<b>Note:</b> An asterisk (*) next to a value indicates the factory default setting.	

Menu item	Description
<b>Repeat Job Expiration</b> Off* 1 Hour 4 Hours 24 Hours 1 Week	Set the expiration time for a print job that you want to repeat.
<b>Verify Job Expiration</b> Off* 1 Hour 4 Hours 24 Hours 1 Week	Set the expiration time that the printer prints a copy for the user to examine its quality, before printing the remaining copies.
<b>Reserve Job Expiration</b> Off* 1 Hour 4 Hours 24 Hours 1 Week	Set the expiration time that the printer stores print jobs for printing at a later time.
<b>Require All Jobs to be Held</b> Off* On	Set the printer to hold all print jobs.
<b>Note:</b> An asterisk (*) next to a value indicates the factory default setting.	

### Solutions LDAP Settings

Use	To
<b>Follow LDAP Referrals</b> Off* On	Search the different servers in the domain for the logged-in user account.
<b>LDAP Certificate Verification</b> No* Yes	Enable verification of LDAP certificates.

### Disk Encryption

**Note:** This menu appears only when a printer hard disk is installed.

Menu item	Description
<b>Status</b> Enabled Disabled	Determine whether Disk Encryption is enabled.

Menu item	Description
<b>Start encryption</b>	Prevent the loss of sensitive data in case the printer or its hard disk is stolen. <b>Note:</b> Enabling disk encryption erases all contents in the hard disk. If necessary, back up important data from the printer before starting the encryption.

### Erase Temporary Data Files

Menu item	Description
<b>Stored in onboard memory</b> Off* On	Delete all files stored on the printer memory.
<b>Stored on hard disk</b> 1 Pass Erase* 3 Pass Erase 7 Pass Erase	Delete all files stored on the printer hard disk.
<b>Note:</b> An asterisk (*) next to a value indicates the factory default setting.	

### Mobile Services Management

Use	To
<b>AirPrint</b> Print Off On*	Enable AirPrint printing.

### Miscellaneous

Menu item	Description
<b>Protected Features</b> Show* Hide	Show all the features that Function Access Control (FAC) protects regardless of the security permission that the user has. <b>Note:</b> FAC manages access to specific menus and functions or disables them entirely.
<b>Print Permission</b> Off* On	Let the user log in before printing.
<b>Default Print Permission Login</b>	Set the default login for Print Permission.
<b>Note:</b> An asterisk (*) next to a value indicates the factory default setting.	



Menu item	Description
<b>Security Reset Jumper</b> Enable “Guest” access* No Effect	Specify the effect of using the security reset jumper. <b>Notes:</b> <ul style="list-style-type: none"> <li>• The jumper is located beside a lock icon on the controller board.</li> <li>• Enable “Guest” access provides full access control to users who are not logged in.</li> <li>• No Effect means that the reset has no effect on the printer security configuration.</li> </ul>
<b>Minimum Password Length</b> 0–32 (0*)	Specify the minimum characters that are allowed for a password.
<b>Note:</b> An asterisk (*) next to a value indicates the factory default setting.	

## Reports

### Menu Settings Page

Menu item	Description
<b>Menu Settings Page</b>	Print a report that contains the printer preferences, settings, and configurations.

### Device

Menu item	Description
<b>Device Information</b>	Print a report that contains information about the printer.
<b>Device Statistics</b>	Print a report about printer usage and supply status.
<b>Profile List</b>	Print a list of profiles that are stored in the printer.
<b>Asset Report</b>	Print a report that contains the printer serial number and model name.

### Print

Menu item	Description
<b>Print Fonts</b> PCL Fonts PS Fonts	Print samples and information about the fonts that are available in each printer language.
<b>Print Directory</b>	Print the resources that are stored in the flash drive or printer hard disk. <b>Note:</b> This menu item appears only when a flash drive or printer hard disk is installed.

## Network

Menu item	Description
<b>Network Setup Page</b>	Print a page that shows the configured network and wireless settings on the printer. <b>Note:</b> This menu item appears only in network printers or printers connected to print servers.

## Help

Menu item	Description
Print All Guides	Prints all the guides
Media Guide	Provides information about loading paper and specialty media
Print Quality Guide	Provides information about solving print quality issues
Mono Quality Guide	Provides information about mono print quality settings
Information Guide	Provides more information sources about the printer
Connection Guide	Provides information about connecting the printer locally (USB) or to a network
Moving Guide	Provides information about moving, locating, or shipping the printer
Supplies Guide	Provides information about ordering supplies

## Troubleshooting

### Troubleshooting

Menu item	Description
<b>Print Quality Test Pages</b>	Print sample pages to identify and correct print quality defects.

## Printing the Menu Settings Page

From the control panel, navigate to:

**Settings > Reports > Menu Settings Page**

For non-touch-screen printer models, press  to navigate through the settings.

## Securing the printer

**Note:** The hard disk is supported only in some printer models.

### Locating the security slot

The printer is equipped with a security lock feature. Attach a security lock compatible with most laptop computers in the location shown to secure the printer in place.

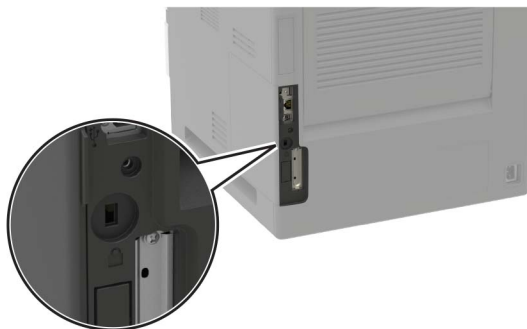

### Erasing printer memory

To erase volatile memory or buffered data in your printer, turn off the printer.

To erase non-volatile memory or individual settings, device and network settings, security settings, and embedded solutions, do the following:

- 1 From the control panel, navigate to:  
**Settings > Device > Maintenance > Out of Service Erase > Sanitize all information on nonvolatile memory**

For non-touch-screen printer models, press  to navigate through the settings.

- 2 Depending on your printer model, select **ERASE** or **Continue**.
- 3 Follow the instructions on the display.

### Erasing printer hard disk memory

- 1 From the control panel, navigate to:  
**Settings > Device > Maintenance > Out of Service Erase > Sanitize all information on hard disk**

For non-touch-screen printer models, press  to navigate through the settings.

- 2 Depending on your printer model, select **ERASE** or **Continue**.
- 3 Follow the instructions on the display.

**Note:** This process can take from several minutes to more than an hour, making the printer unavailable for other tasks.

## Encrypting the printer hard disk

This process erases all contents in the hard disk. If necessary, back up important data from the printer before starting the encryption.

1 From the control panel, navigate to:

**Settings > Security > Disk Encryption > Start encryption**

For non-touch-screen printer models, press  to navigate through the settings.

2 Follow the instructions on the display.

### Notes:

- To avoid loss of data, do not turn off the printer during the encryption process.
- This process can take from several minutes to more than an hour, making the printer unavailable for other tasks.
- After encryption, the printer automatically restarts.

## Restoring factory default settings

1 From the control panel, navigate to:

**Settings > Device > Restore Factory Defaults**

For non-touch-screen printer models, press  to navigate through the settings.

2 In the Restore Settings menu, select the settings that you want to restore.

3 Select **RESTORE**.

4 Follow the instructions on the display.

## Statement of Volatility

Type of memory	Description
Volatile memory	The printer uses standard random access memory (RAM) to buffer temporarily user data during simple print and copy jobs.
Non-volatile memory	The printer may use two forms of non-volatile memory: EEPROM and NAND (flash memory). Both types are used to store the operating system, printer settings, network information, scanner and bookmark settings, and embedded solutions.

Type of memory	Description
Hard disk memory	Some printers may have a hard disk drive installed. The printer hard disk is designed for printer-specific functionality. The hard disk lets the printer retain buffered user data from complex print jobs, form data, and font data.

Erase the content of any installed printer memory in the following circumstances:

- The printer is decommissioned.
- The printer hard disk is replaced.
- The printer is moved to a different department or location.
- The printer is serviced by someone from outside your organization.
- The printer is removed from your premises for service.
- The printer is sold to another organization.

### Disposing of a printer hard disk

- **Degaussing**—Flushes the hard disk with a magnetic field that erases stored data
- **Crushing**—Physically compresses the hard disk to break component parts and render them unreadable
- **Milling**—Physically shreds the hard disk into small metal bits

**Note:** To guarantee that all data are completely erased, destroy physically each hard disk where data is stored.

# Maintaining the printer

**Warning—Potential Damage:** Failure to maintain optimum printer performance, or to replace parts and supplies, may cause damage to your printer.

## Adjusting the speaker volume

### Adjusting the default internal speaker volume

The speaker volume will reset to default value after the session is logged out, when the printer wakes from Sleep or Hibernate mode, or after a power-on reset.

- 1 From the control panel, navigate to:  
**Settings > Device > Preferences > Audio Feedback**
- 2 Select the volume.

**Note:** If Quiet Mode is enabled, then audible alerts are turned off.

### Adjusting the default headphones volume

Headphones volume will reset to default value after the session is logged out, when the printer wakes from Sleep or Hibernate mode, or after a power-on reset.

- 1 From the control panel, select **Settings > Device > Accessibility > Headphone Volume**.
- 2 Select the volume.

## Networking

**Note:** For information on installing the wireless network adapter, see the setup sheet that came with the adapter.

### Connecting the printer to a Wi-Fi network

- 1 From the printer control panel, navigate to:  
**Settings > Network/Ports > Wireless**

For non-touch-screen printer models, press  to navigate through the settings.

- 2 Select **Setup On Printer Panel** and then follow the instructions on the display.

**Note:** For Wi-Fi-network-ready printer models, a prompt for Wi-Fi network setup appears during initial setup.

## Connecting the printer to a wireless network using Wi-Fi Protected Setup (WPS)

Before you begin, make sure that:

- The access point (wireless router) is WPS-certified or WPS-compatible. For more information, see the documentation that came with your access point.
- A wireless network adapter is installed in your printer. For more information, see the instructions that came with the adapter.

### Using the Push Button method

- 1 From the control panel, navigate to:  
**Settings > Network/Ports > Wireless > Wi-Fi Protected Setup > Start Push Button Method**
- 2 Follow the instructions on the display.

### Using the personal identification number (PIN) method

- 1 From the control panel, navigate to:  
**Settings > Network/Ports > Wireless > Wi-Fi Protected Setup > Start PIN Method**
- 2 Copy the eight-digit WPS PIN.
- 3 Open a Web browser, and then type the IP address of your access point in the address field.

#### Notes:

- View the printer IP address on the printer home screen. The IP address appears as four sets of numbers separated by periods, such as 123.123.123.123.
  - If you are using a proxy server, then temporarily disable it to load the Web page correctly.
- 4 Access the WPS settings. For more information, see the documentation that came with your access point.
  - 5 Enter the eight-digit PIN, and then save the changes.

## Deactivating the Wi-Fi network

- 1 From the printer control panel, navigate to:  
**Settings > Network/Ports > Network Overview > Active Adapter > Standard Networking**

For non-touch-screen printer models, press  to navigate through the settings.

- 2 Follow the instructions on the display.

## Changing the printer port settings after installing an internal solutions port

### Notes:

- If the printer has a static IP address, then do not change the configuration.
- If the computers are configured to use the network name instead of an IP address, then do not change the configuration.
- If you are adding a wireless internal solutions port (ISP) to a printer previously configured for an Ethernet connection, then disconnect the printer from the Ethernet network.

### For Windows users

- 1 Open the printers folder.
- 2 From the shortcut menu of the printer with the new ISP, open the printer properties.
- 3 Configure the port from the list.
- 4 Update the IP address.
- 5 Apply the changes.

### For Macintosh users

- 1 From System Preferences in the Apple menu, navigate to the list of printers, and then select + > **IP**.
- 2 Type the IP address in the address field.
- 3 Apply the changes.

## Cleaning the printer



**CAUTION—SHOCK HAZARD:** To avoid the risk of electrical shock when cleaning the exterior of the printer, unplug the power cord from the electrical outlet and disconnect all cables from the printer before proceeding.

### Notes:

- Perform this task after every few months.
  - Damage to the printer caused by improper handling is not covered by the printer warranty.
- 1 Turn off the printer, and then unplug the power cord from the electrical outlet.
  - 2 Remove paper from the standard bin and multipurpose feeder.
  - 3 Remove any dust, lint, and pieces of paper around the printer using a soft brush or vacuum.
  - 4 Wipe the outside of the printer with a damp, soft, lint-free cloth.

### Notes:

- Do not use household cleaners or detergents, as they may damage the finish of the printer.



- Make sure that all areas of the printer are dry after cleaning.

5 Connect the power cord to the electrical outlet, and then turn on the printer.

 **CAUTION—POTENTIAL INJURY:** To avoid the risk of fire or electrical shock, connect the power cord to an appropriately rated and properly grounded electrical outlet that is near the product and easily accessible.

## Ordering parts and supplies

To order parts and supplies in the U.S., contact Lexmark at 1-800-539-6275 for information about Lexmark authorized supplies dealers in your area. In other countries or regions, go to [www.lexmark.com](http://www.lexmark.com) or contact the place where you purchased the printer.

**Note:** All life estimates for printer supplies assume printing on letter- or A4-size plain paper.

## Checking the status of parts and supplies

1 From the control panel, navigate to:

**Settings > Reports > Device > Device Statistics**

For non-touch-screen printer models, press  to navigate through the settings.

2 From the Supply Information section of the pages printed, check the status of parts and supplies.

## Using genuine Lexmark parts and supplies

Your Lexmark printer is designed to function best with genuine Lexmark parts and supplies. Use of third-party supplies or parts may affect the performance, reliability, or life of the printer and its imaging components. It can also affect warranty coverage. Damage caused by the use of third-party parts and supplies is not covered by the warranty. All life indicators are designed to function with Lexmark parts and supplies, and may deliver unpredictable results if third-party parts and supplies are used. Imaging component usage beyond the intended life may damage your Lexmark printer or its associated components.

## Ordering a toner cartridge

### Notes:

- The estimated cartridge yield is based on the ISO/IEC 19752 standard.
- Extremely low print coverage for extended periods of time may negatively affect actual yield.

**MS821, MS822, MS823, MS824, MS725, MS825, and MS826 Return Program toner cartridges**

Item	United States and Canada	European Economic Area	Asia Pacific	Latin America	Rest of Europe, Middle East, and Africa	Australia and New Zealand	Worldwide
Return Program toner cartridge	58D1000	58D2000	58D3000	58D4000	58D5000	58D6000	58D000G
High yield Return Program toner cartridge	58D1H00	58D2H00	58D3H00	58D4H00	58D5H00	58D6H00	58D0H0G
High yield Corporate Return Program toner cartridge <sup>1</sup>	58D1H0E	58D2H0E	58D3H0E	58D4H0E	58D5H0E	58D6H0E	N/A
Extra high yield Return Program toner cartridge <sup>2</sup>	58D1X00	58D2X00	58D3X00	58D4X00	58D5X00	58D6X00	58D0X0G
Extra high yield Corporate Return Program toner cartridge <sup>1,2</sup>	58D1X0E	58D2X0E	58D3X0E	58D4X0E	58D5X0E	58D6X0E	N/A
Ultra high yield Return Program toner cartridge <sup>2</sup>	58D1U00	58D2U00	58D3U00	58D4U00	58D5U00	58D6U00	58D0U0G
Ultra high yield Corporate Return Program toner cartridge <sup>1,2</sup>	58D1U0E	58D2U0E	58D3U0E	58D4U0E	58D5U0E	58D6U0E	N/A

<sup>1</sup> This toner cartridge is available only for contract-managed printers. For more information, contact your Lexmark representative or system administrator.

<sup>2</sup> This toner cartridge is supported only in MS823, MS824, MS725, MS825, and MS826 printer models.

**M5255, M5265, and M5270 Return Program toner cartridges**

Item	United States, Canada, Australia, and New Zealand	Europe, Middle East, and Africa	Asia Pacific	Latin America
Return Program toner cartridge	25B3074	25B3079	25B3120	25B3124

**B2865 Return Program toner cartridges**

Item	United States and Canada	European Economic Area	Asia Pacific	Latin America	Rest of Europe, Middle East, and Africa	Australia and New Zealand
Return Program toner cartridge	B281000	B282000	B283000	B284000	B285000	B286000
High yield Return Program toner cartridge	B281H00	B282H00	B283H00	B284H00	B285H00	B286H00
Extra high yield Return Program toner cartridge	B281X00	B282X00	B283X00	B284X00	B285X00	B286X00

**Regular toner cartridges**

Item	Worldwide
High yield toner cartridge <sup>1</sup>	58D0HA0
Extra high yield toner cartridge <sup>2</sup>	B280XA0
Ultra high yield toner cartridge <sup>3</sup>	58D0UA0

<sup>1</sup> This toner cartridge is supported only in MS821 and MS822 printer models.

<sup>2</sup> This toner cartridge is supported only in the B2865 printer model.

<sup>3</sup> This toner cartridge is supported only in MS823, MS824, MS725, MS825, and MS826 printer models.

**Ordering an imaging unit**

Extremely low print coverage for extended periods of time may cause imaging unit parts to fail before the toner exhaustion.

Item	Lexmark Return Program	Corporate Return Program*	Regular
Imaging unit	58D0Z00	58D0Z0E	58D0ZA0

\* This imaging unit is available only for contract-managed printers. For more information, contact your Lexmark representative or system administrator.

## Ordering a staple cartridge

Part name	Part number
Staple cartridge	35S8500

## Ordering a maintenance kit

To identify the fuser type, open door A, and then remove the toner cartridge and imaging unit. Find the two-digit fuser type in front of the fuser, for example, 00 or 01.

**Warning—Potential Damage:** Do not expose the imaging unit to direct light for more than 10 minutes. Extended exposure to light may cause print quality problems.

### Notes:

- Using certain types of paper may require more frequent replacement of the maintenance kit.
- The separator assembly, fuser, pick roller assembly, and transfer roller are included in the maintenance kit and can be ordered individually and replaced if necessary.
- For more information on replacing the maintenance kit, see the documentation that came with the kit.

### Return Program fuser maintenance kits

Fuser maintenance kit type	Part number
Type 00	41X2233
Type 01	41X2234
Type 02	41X2235
Type 03	41X2236
Type 04	41X2237
Type 11	41X2242
Type 13	41X2243
Type 32	41X2250
Type 33	41X2251
Type 35	41X2252
Type 36	41X2253

### Regular fuser maintenance kits

Fuser maintenance kit type	Part number
Type 05	41X2238
Type 06	41X2239
Type 07	41X2240
Type 08	41X2241

Fuser maintenance kit type	Part number
Type 17	41X2244
Type 19	41X2245

### Roller maintenance kit

Item	Part number
Printer engine roller maintenance kit	41X2352

## Configuring supply notifications

- 1 Open a web browser, and then type the printer IP address in the address field.

#### Notes:

- View the printer IP address on the printer home screen. The IP address appears as four sets of numbers separated by periods, such as 123.123.123.123.
- If you are using a proxy server, then temporarily disable it to load the web page correctly.

- 2 Click **Settings** > **Device** > **Notifications**.
- 3 From the Supplies menu, click **Custom Supply Notifications**.
- 4 Select a notification for each supply item.
- 5 Apply the changes.

## Replacing parts and supplies

### Replacing the toner cartridge

- 1 Open door A.

**Warning—Potential Damage:** To prevent damage from electrostatic discharge, touch any exposed metal frame of the printer before accessing or touching interior areas of the printer.



- 2 Remove the used toner cartridge.

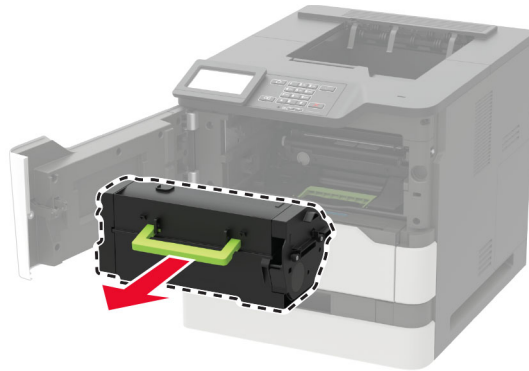

- 3 Unpack the new toner cartridge, and then shake it to redistribute the toner.

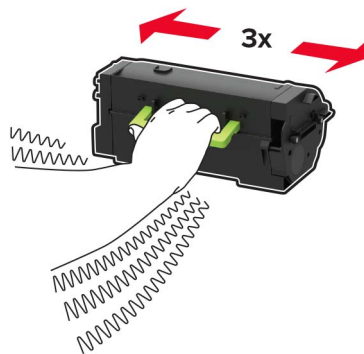

- 4 Insert the new toner cartridge.



- 5 Close the door.

## Replacing the imaging unit

- 1 Open door A.

**Warning—Potential Damage:** To prevent damage from electrostatic discharge, touch any exposed metal frame of the printer before accessing or touching interior areas of the printer.



**2** Remove the toner cartridge.



**3** Remove the used imaging unit.



- 4 Unpack the new imaging unit, and then shake it to redistribute the toner.

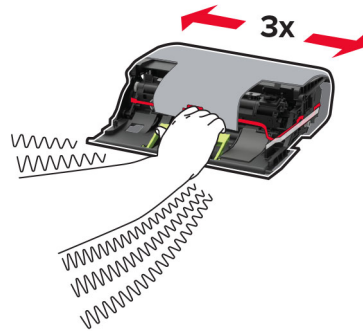

**Warning—Potential Damage:** Do not expose the imaging unit to direct light for more than 10 minutes. Extended exposure to light may cause print quality problems.

**Warning—Potential Damage:** Do not touch the photoconductor drum. Doing so may affect the quality of future print jobs.



- 5 Remove the packing material.
- 6 Insert the new imaging unit.





- 7 Insert the toner cartridge.



- 8 Close the door.

## Replacing the fuser

- 1 Open door C.

 **CAUTION—HOT SURFACE:** The inside of the printer might be hot. To reduce the risk of injury from a hot component, allow the surface to cool before touching it.

**Warning—Potential Damage:** To prevent damage from electrostatic discharge, touch any exposed metal frame of the printer before accessing or touching interior areas of the printer.

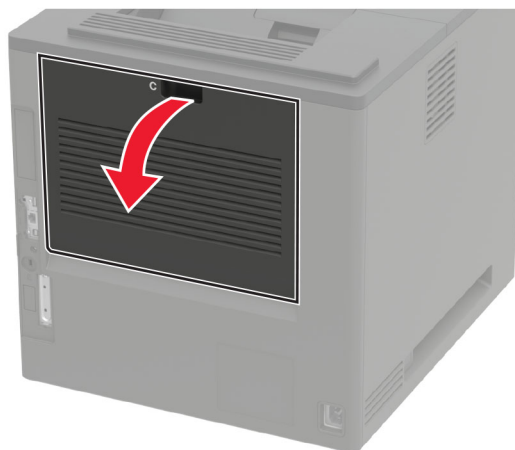

**2** Unlock the fuser.

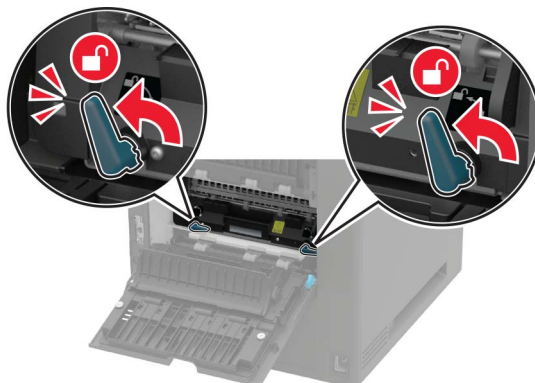

**3** Remove the used fuser.

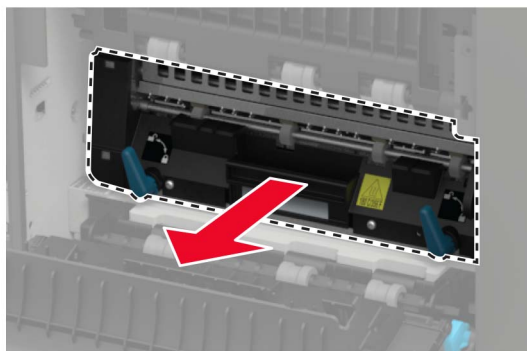

**4** Unpack the new fuser.

**5** Insert the new fuser until it *clicks* into place.

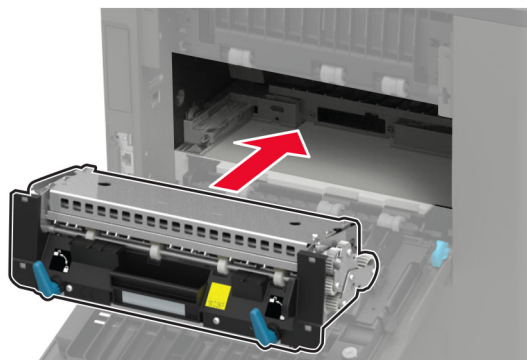

- 6 Lock the fuser.

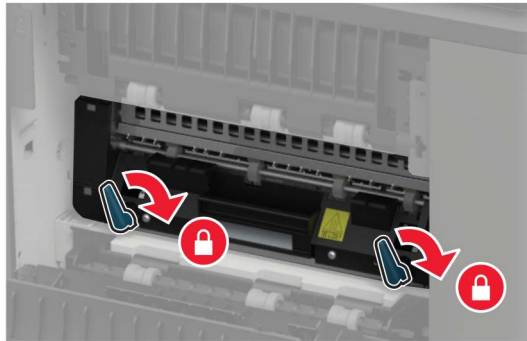

- 7 Close the door.

## Replacing the hot roll fuser

- 1 Remove the standard bin cover.

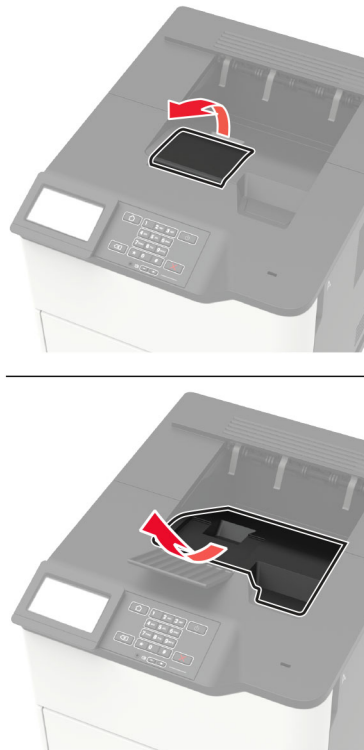

- 2 Open door C.

 **CAUTION—HOT SURFACE:** The inside of the printer might be hot. To reduce the risk of injury from a hot component, allow the surface to cool before touching it.

**Warning—Potential Damage:** To prevent damage from electrostatic discharge, touch any exposed metal frame of the printer before accessing or touching interior areas of the printer.

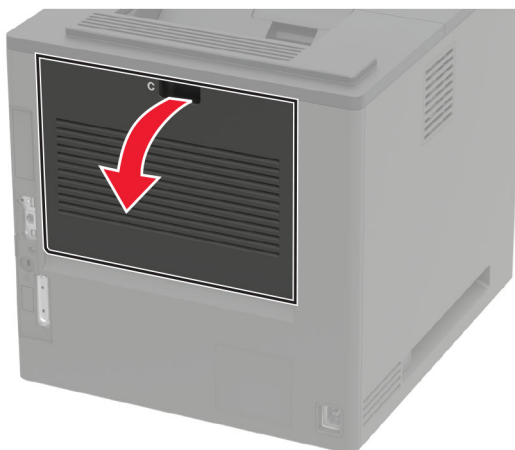

**3** Unlock the hot roll fuser.

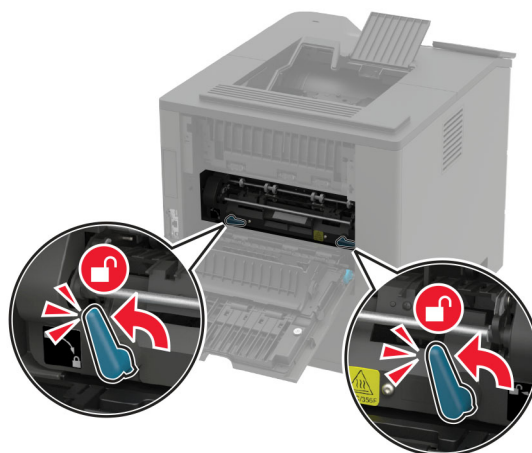

**4** Remove the used hot roll fuser.

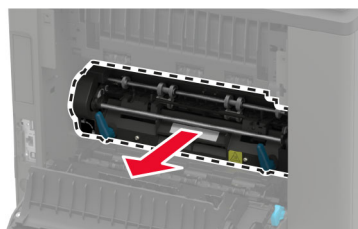

**5** Unpack the new hot roll fuser.

- 6 Insert the new hot roll fuser until it *clicks* into place.

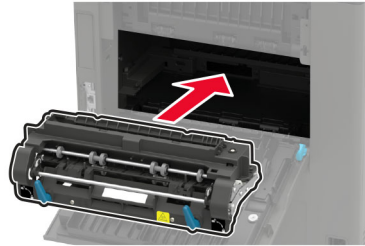

- 7 Lock the hot roll fuser.

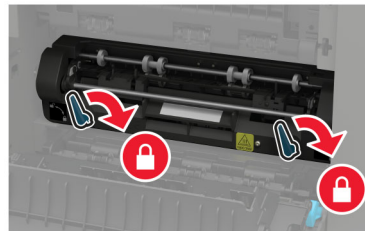

- 8 Close the door.

- 9 Install the standard bin cover.

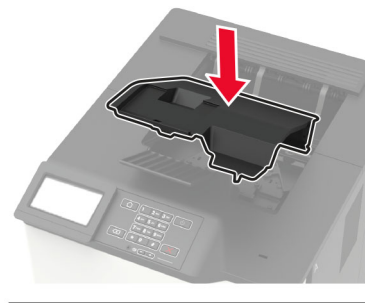

## Replacing the transfer roller

- 1 Open door A.

**Warning—Potential Damage:** To prevent damage from electrostatic discharge, touch any exposed metal frame of the printer before accessing or touching interior areas of the printer.



2 Remove the toner cartridge.

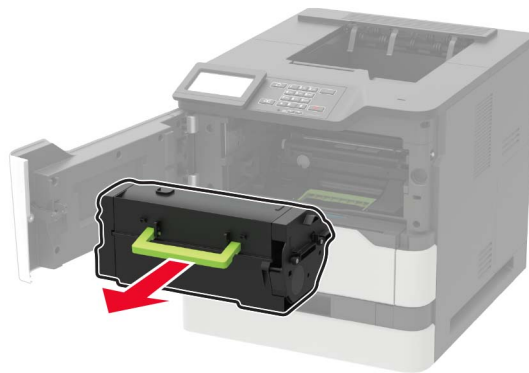

3 Remove the imaging unit.



4 Remove the used transfer roller.



**CAUTION—HOT SURFACE:** The inside of the printer might be hot. To reduce the risk of injury from a hot component, allow the surface to cool before touching it.

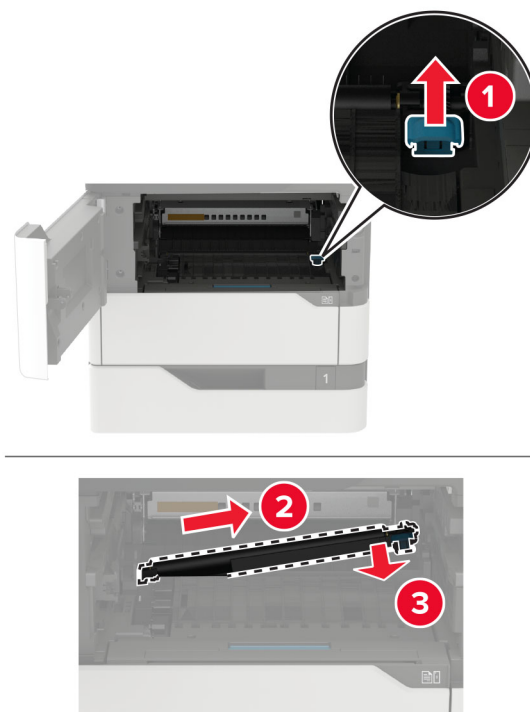

5 Unpack the new transfer roller.

6 Insert the new transfer roller until it *clicks* into place.

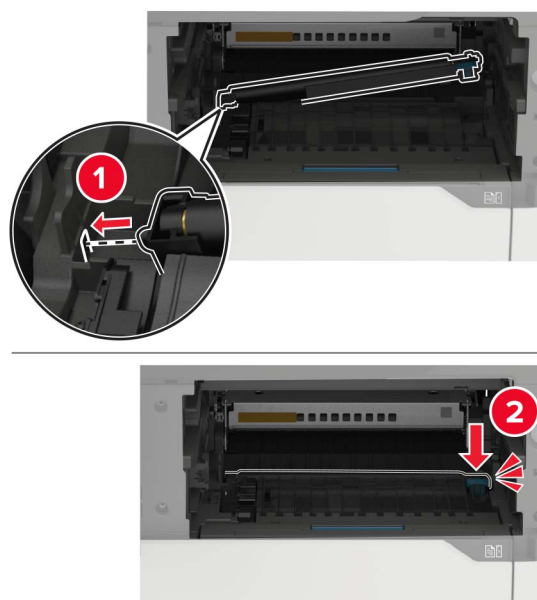

- 7 Insert the imaging unit.

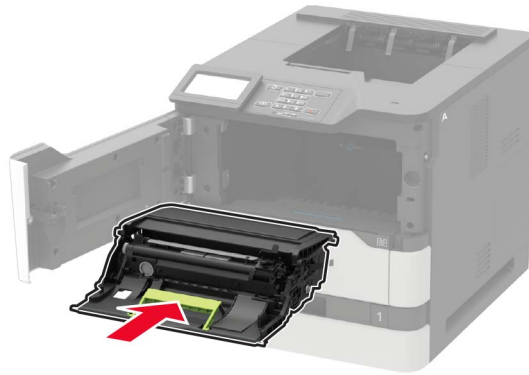

- 8 Insert the toner cartridge.

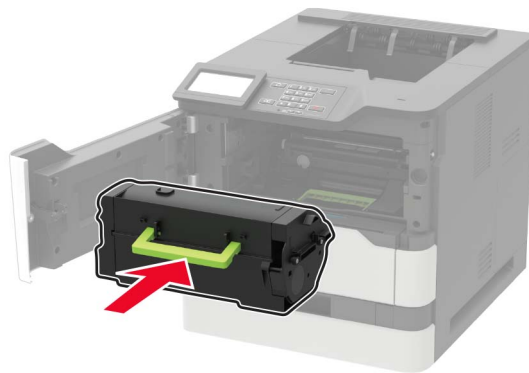

- 9 Close the door.

## Replacing the pick roller

- 1 Remove the tray.

**Warning—Potential Damage:** To prevent damage from electrostatic discharge, touch any exposed metal frame of the printer before accessing or touching interior areas of the printer.





- 2 Remove the used pick roller.

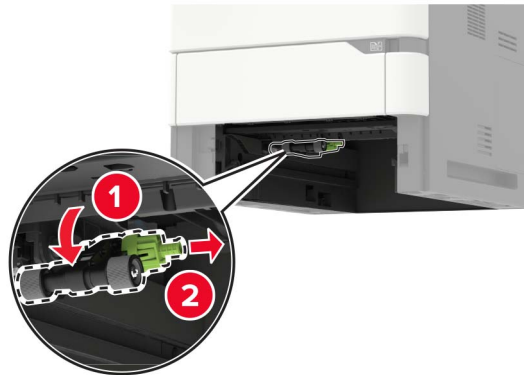

- 3 Unpack the new pick roller.
- 4 Install the new pick roller.

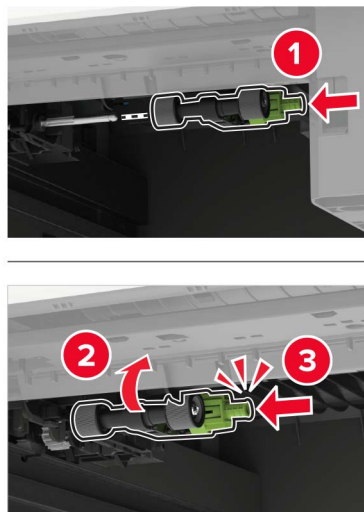

- 5 Insert the tray.

## Replacing the pick roller in the multipurpose feeder

- 1 Open the multipurpose feeder.

**Warning—Potential Damage:** To prevent damage from electrostatic discharge, touch any exposed metal frame of the printer before accessing or touching interior areas of the printer.



**2** Remove the used pick roller.

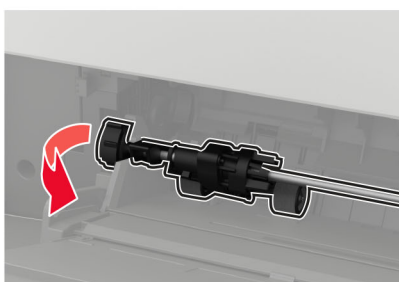

**3** Unpack the new pick roller.

**4** Install the new pick roller.

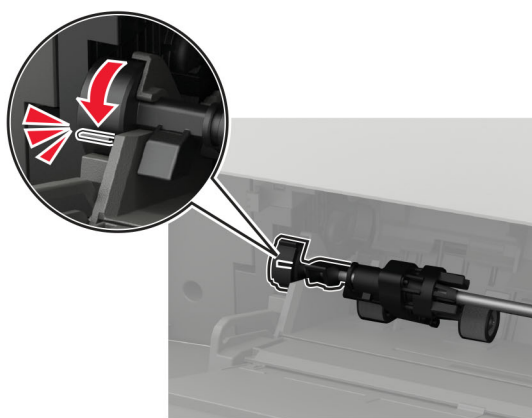
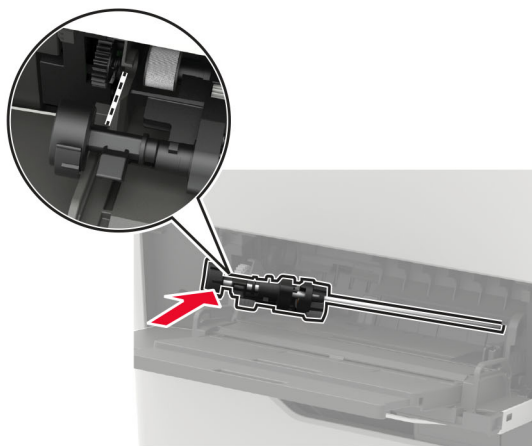
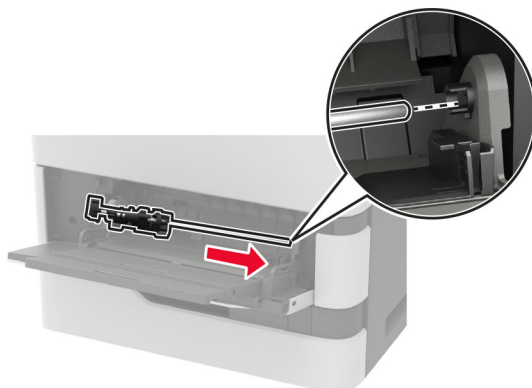

**5** Close the multipurpose feeder.

## Replacing the staple cartridge in the staple finisher

1 Open door F.

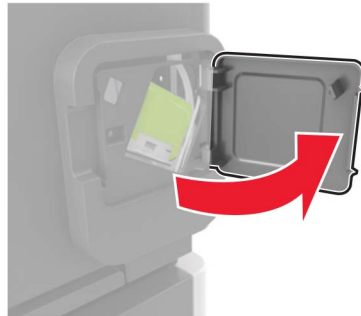

2 Remove the staple cartridge holder.

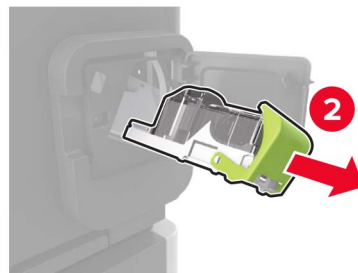
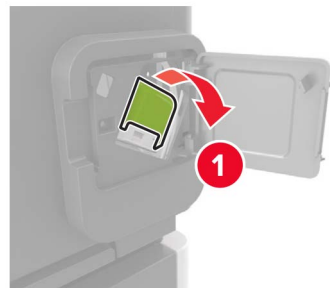

3 Remove the empty staple cartridge.

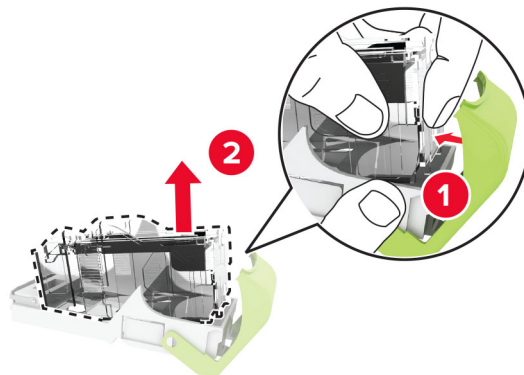

4 Insert the new staple cartridge.

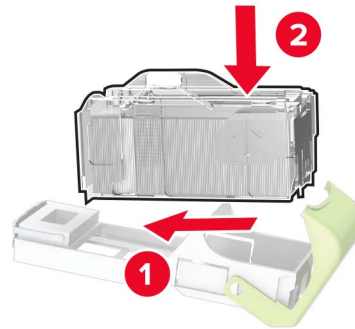

5 Insert the staple cartridge holder.

6 Close the door.

## Replacing the staple cartridge in the staple, hole punch finisher

1 Depending on the staple cartridge to replace, open either door F or door G.

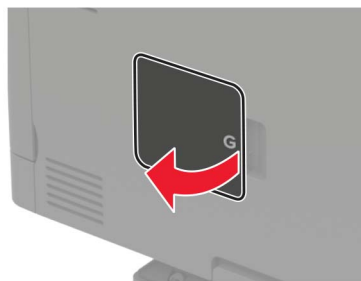
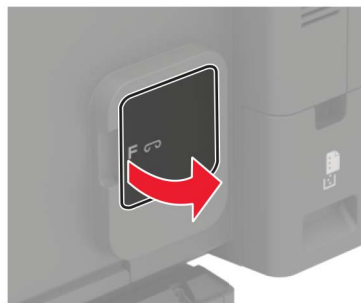

**2** Remove the staple cartridge holder.

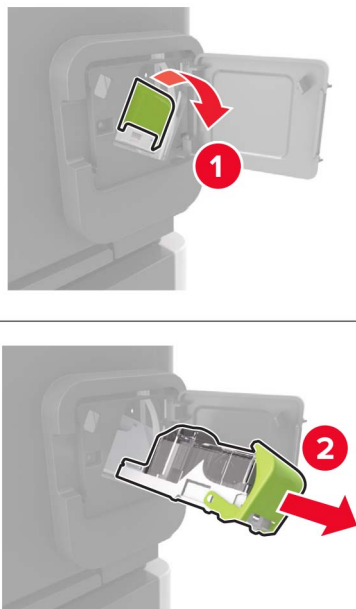

**3** Remove the empty staple cartridge.

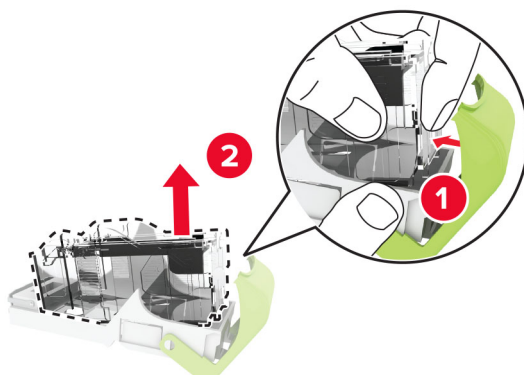

**4** Insert the new staple cartridge.

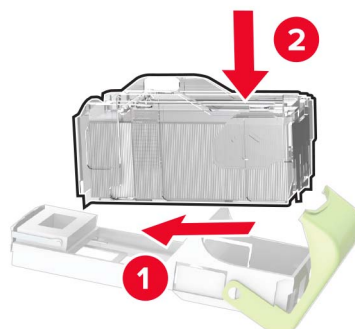



**5** Insert the staple cartridge holder.

**6** Close the door.

## Moving the printer

### Moving the printer to another location

 **CAUTION—POTENTIAL INJURY:** If the printer weight is greater than 18 kg (40 lb), then it requires two or more trained personnel to lift it safely.

 **CAUTION—POTENTIAL INJURY:** To avoid the risk of fire or electrical shock, use only the power cord provided with this product or the manufacturer's authorized replacement.

 **CAUTION—POTENTIAL INJURY:** When moving the printer, follow these guidelines to avoid personal injury or printer damage:

- Make sure that all doors and trays are closed.
- Turn off the printer, and then unplug the power cord from the electrical outlet.
- Disconnect all cords and cables from the printer.
- If the printer has separate floor-standing optional trays or output options attached to it, then disconnect them before moving the printer.
- If the printer has a caster base, then carefully roll it to the new location. Use caution when passing over thresholds and breaks in flooring.
- If the printer does not have a caster base but is configured with optional trays or output options, then remove the output options and lift the printer off the trays. Do not try to lift the printer and any options at the same time.
- Always use the handholds on the printer to lift it.
- Any cart used to move the printer must have a surface able to support the full footprint of the printer.
- Any cart used to move the hardware options must have a surface able to support the dimensions of the options.
- Keep the printer in an upright position.
- Avoid severe jarring movements.
- Make sure that your fingers are not under the printer when you set it down.
- Make sure that there is adequate clearance around the printer.

**Note:** Damage to the printer caused by improper moving is not covered by the printer warranty.

### Shipping the printer

For shipping instructions, go to <http://support.lexmark.com> or contact customer support.

# Saving energy and paper

## Configuring the power save mode settings

For non-touch-screen printer models, press  to navigate through the settings.

### Eco-Mode

- 1 From the control panel, navigate to:  
**Settings > Device > Power Management > Eco-Mode**
- 2 Select a setting.

### Sleep mode

- 1 From the control panel, navigate to:  
**Settings > Device > Power Management > Timeouts > Sleep Mode**
- 2 Specify the amount of time that the printer stays idle before it enters Sleep mode.

### Hibernate mode

- 1 From the control panel, navigate to:  
**Settings > Device > Power Management > Timeouts > Hibernate Timeout**
- 2 Select the amount of time that the printer stays idle before it enters Hibernate mode.

#### Notes:

- For Hibernate Timeout to work, set Hibernate Timeout on Connection to Hibernate.
- The Embedded Web Server is disabled when the printer is in Hibernate mode.

## Adjusting the brightness of the display

**Note:** This setting is available only in some printer models.

- 1 From the control panel, navigate to:  
**Settings > Device > Preferences**

For non-touch-screen printer models, press  to navigate through the settings.

- 2 In the Screen Brightness menu, adjust the setting.

## Conserving supplies

- Print on both sides of the paper.  
**Note:** Two-sided printing is the default setting in the print driver.
- Print multiple pages on a single sheet of paper.
- Use the preview feature to see how the document looks like before printing it.
- Print one copy of the document to check its content and format for accuracy.



## Recycling

### Recycling Lexmark products

To return Lexmark products for recycling:

- 1 Go to [www.lexmark.com/recycle](http://www.lexmark.com/recycle).
- 2 Select the product you want to recycle.

**Note:** Printer supplies and hardware not listed in the Lexmark Collection and Recycling Program may be recycled through your local recycling center.

### Recycling Lexmark packaging

Lexmark continually strives to minimize packaging. Less packaging helps to ensure that Lexmark printers are transported in the most efficient and environmentally sensitive manner and that there is less packaging to dispose of. These efficiencies result in fewer greenhouse emissions, energy savings, and natural resource savings. Lexmark also offers recycling of packaging components in some countries or regions. For more information, go to [www.lexmark.com/recycle](http://www.lexmark.com/recycle), and then choose your country or region. Information on available packaging recycling programs is included with the information on product recycling.

Lexmark cartons are 100% recyclable where corrugated recycling facilities exist. Facilities may not exist in your area.

The foam used in Lexmark packaging is recyclable where foam recycling facilities exist. Facilities may not exist in your area.

When you return a cartridge to Lexmark, you can reuse the box that the cartridge came in. Lexmark recycles the box.

### Returning Lexmark cartridges for reuse or recycling

The Lexmark Cartridge Collection Program allows you to return used cartridges for free to Lexmark for reuse or recycling. One hundred percent of the empty cartridges returned to Lexmark are either reused or demanufactured for recycling. The boxes used to return the cartridges are also recycled.

To return Lexmark cartridges for reuse or recycling, do the following:

- 1 Go to [www.lexmark.com/recycle](http://www.lexmark.com/recycle).
- 2 Select the product that you want to recycle.

# Clearing jams

## Avoiding jams

### Load paper properly

- Make sure paper lies flat in the tray.

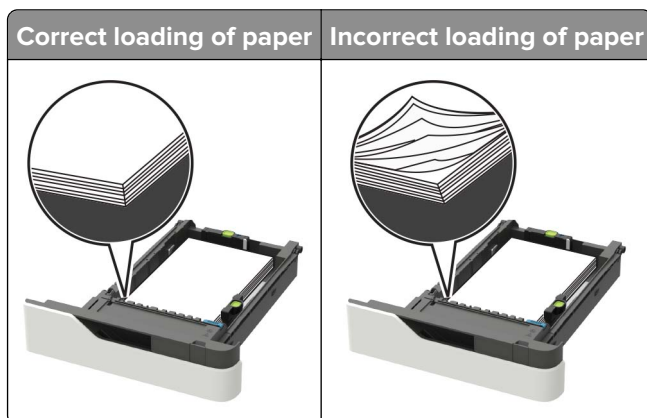

- Do not remove a tray while the printer is printing.
- Do not load a tray while the printer is printing. Load it before printing, or wait for a prompt to load it.
- Do not load too much paper. Make sure the stack height is below the maximum paper fill indicator.
- Do not slide the paper into the tray. Load paper as shown in the illustration.

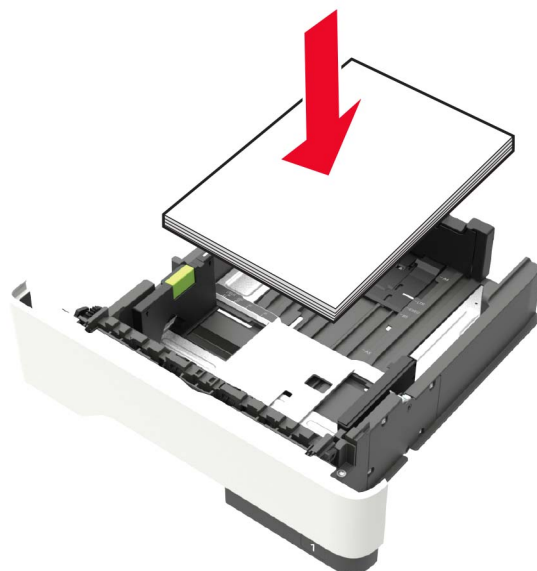

- Make sure the guides in the tray or the multipurpose feeder are properly positioned and are not pressing tightly against the paper or envelopes.
- Push the tray firmly into the printer after loading paper.
- If you are loading prepunched paper for use with the staple finisher, then make sure the holes on the long edge of the paper are on the right side of the tray. For more information, see the “Loading paper and specialty media” section of the *User’s Guide*.

## Allow the paper to enter the optional mailbox bins properly

- Make sure to adjust the bin extender so that the paper size indicators match the size of the paper used.

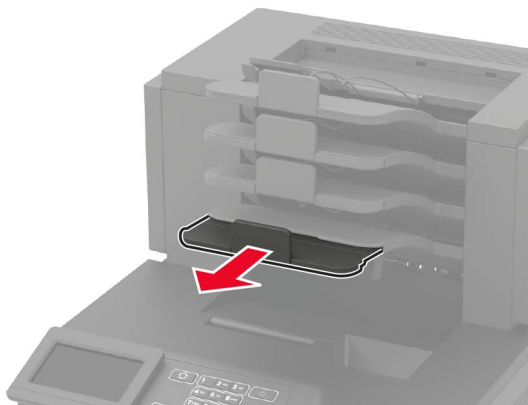

### Notes:

- If the bin extender is shorter than the size of the paper you are printing on, then the paper causes a jam in the mailbox bin. For example, if you are printing on a legal-size paper and the bin extender is set to letter-size, then a jam occurs.
- If the bin extender is longer than the size of the paper you are printing on, then the edges become uneven and the paper is not stacked properly. For example, if you are printing on a letter-size paper and the bin extender is set to legal-size, then the paper does not stack properly.
- If paper needs to be returned to the mailbox bin, then insert the paper under the bin arm, and then push the paper all the way back.

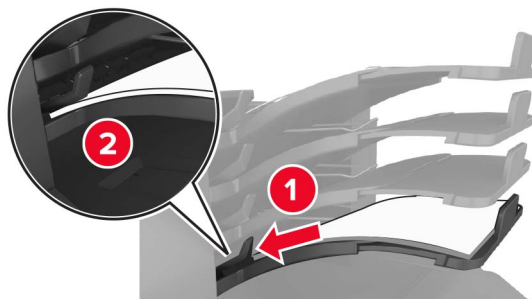

**Note:** If the paper is not under the bin arm, then a jam occurs due to an overfilled bin.

## Use recommended paper

- Use only recommended paper or specialty media.
- Do not load wrinkled, creased, damp, bent, or curled paper.

- Flex, fan, and straighten paper or specialty media before loading it.

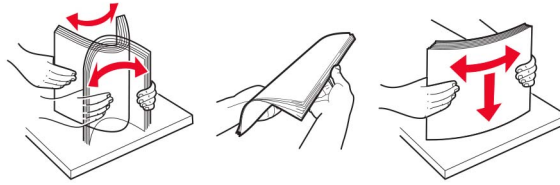

- Do not use paper that has been cut or trimmed by hand.
- Do not mix paper sizes, weights, or types in the same tray.
- Make sure the paper size and type are set correctly on the computer or printer control panel.
- Store paper per manufacturer recommendations.

## Identifying jam locations

### Notes:

- When Jam Assist is set to On, the printer flushes blank pages or pages with partial prints after a jammed page has been cleared. Check your printed output for blank pages.
- When Jam Recovery is set to On or Auto, the printer reprints jammed pages.

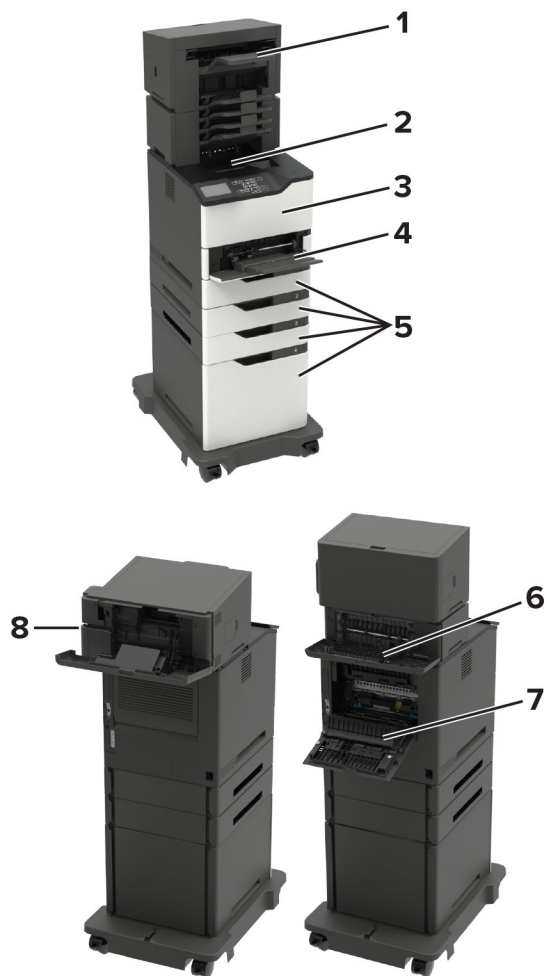

Jam locations	
<b>1</b>	Finisher or output option bin
<b>2</b>	Standard bin
<b>3</b>	Door A
<b>4</b>	Multipurpose feeder
<b>5</b>	Trays
<b>6</b>	Finisher or output option rear door <ul style="list-style-type: none"> <li>• Door H</li> <li>• Door K</li> <li>• Door L</li> <li>• Door N</li> <li>• Door P</li> </ul>
<b>7</b>	Door C
<b>8</b>	Staple cartridge access door <ul style="list-style-type: none"> <li>• Door F</li> <li>• Door G</li> </ul>

## Paper jam in trays

- 1 Remove the tray.

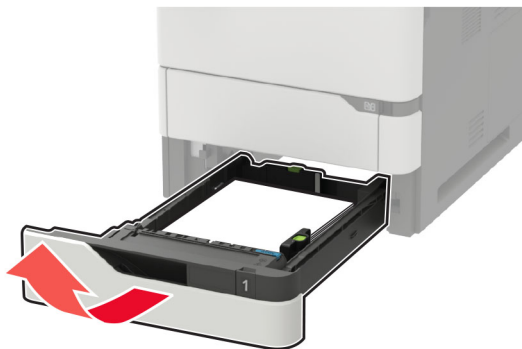

- 2 Remove the jammed paper.

**Note:** Make sure that all paper fragments are removed.



- 3 Insert the tray.

## Paper jam in door A

- 1 Open door A.

**Warning—Potential Damage:** To prevent damage from electrostatic discharge, touch any exposed metal frame of the printer before accessing or touching interior areas of the printer.



- 2 Remove the toner cartridge.



- 3 Remove the imaging unit.



**Warning—Potential Damage:** Do not expose the imaging unit to direct light for more than 10 minutes. Extended exposure to light may cause print quality problems.

**Warning—Potential Damage:** Do not touch the photoconductor drum. Doing so may affect the quality of future print jobs.



- 4 Pull out the duplex unit.

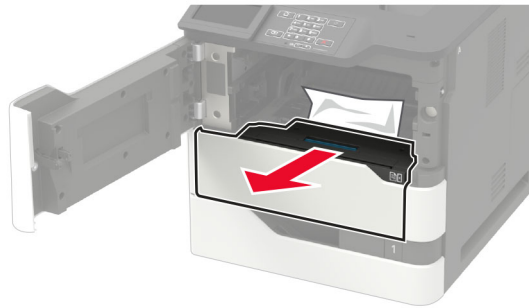

- 5 Remove the jammed paper.

**Note:** Make sure that all paper fragments are removed.

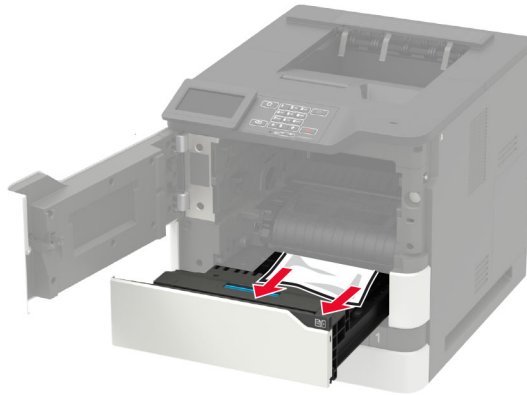

- 6 Insert the duplex unit.

- 7 Insert the imaging unit.





- 8 Insert the toner cartridge.



- 9 Close the door.

## Paper jam in door C

- 1 Open door C.

 **CAUTION—HOT SURFACE:** The inside of the printer might be hot. To reduce the risk of injury from a hot component, allow the surface to cool before touching it.

**Warning—Potential Damage:** To prevent damage from electrostatic discharge, touch any exposed metal frame of the printer before accessing or touching interior areas of the printer.

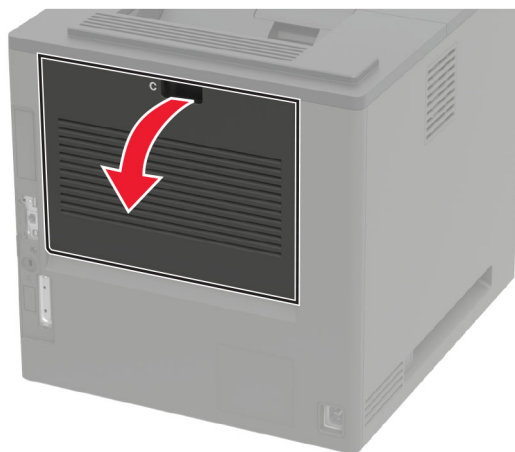

- 2 Remove the jammed paper from any of the following areas:

**Note:** Make sure that all paper fragments are removed.

- Fuser area



- Below the fuser area

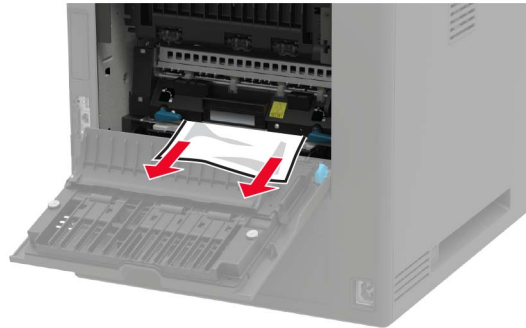

- Duplex area



**3** Close the door.

## Paper jam in the standard bin

Remove the jammed paper.

**Note:** Make sure that all paper fragments are removed.



## Paper jam in the multipurpose feeder

- 1 Remove paper from the multipurpose feeder.



- 2 Remove the jammed paper.

**Note:** Make sure that all paper fragments are removed.

- 3 Flex, fan, and align the paper edges before loading.

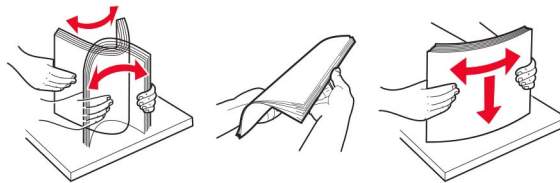

- 4 Reload paper.



## Paper jam in the output expander

- 1 Open door K.

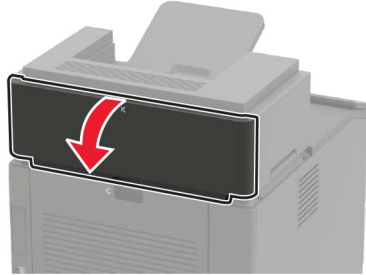

- 2 Remove the jammed paper.

**Note:** Make sure that all paper fragments are removed.

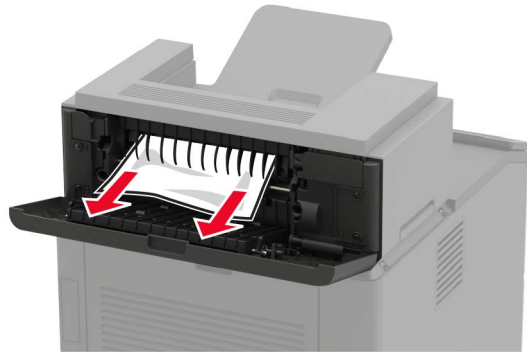

- 3 Close the door.

## Paper jam in the high-capacity output expander

- 1 Open door L.

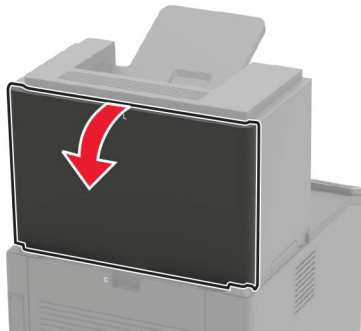

- 2 Remove the jammed paper.

**Note:** Make sure that all paper fragments are removed.



3 Close the door.

## Paper jam in the 4-bin mailbox

### Paper jam in door N

1 Open door N.

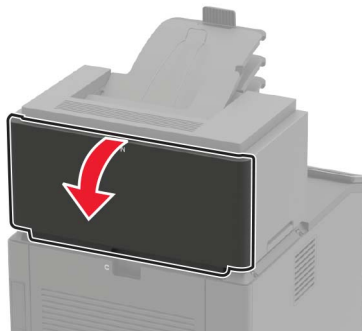

2 Remove the jammed paper.

**Note:** Make sure that all paper fragments are removed.

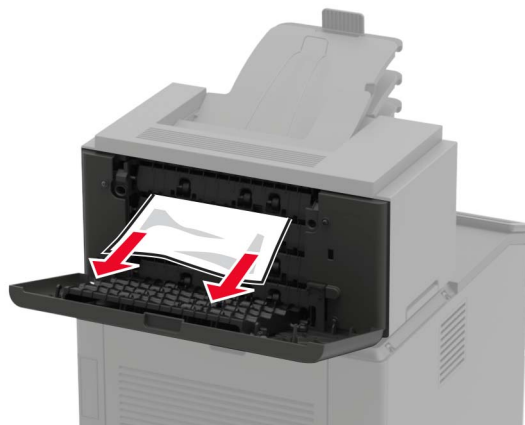

- 3 Close the door.

### Paper jam in the mailbox bin

Remove the jammed paper.

**Note:** Make sure that all paper fragments are removed.

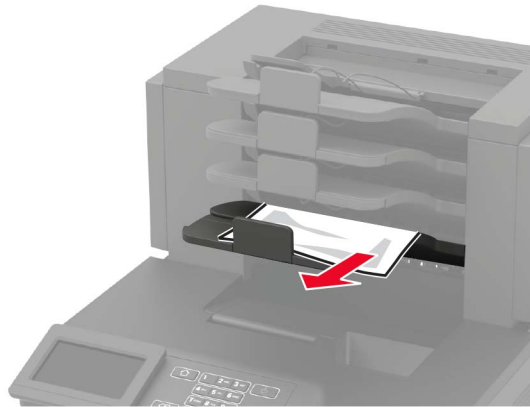

## Paper jam in the staple finisher

### Paper jam in door H

- 1 Open door H.

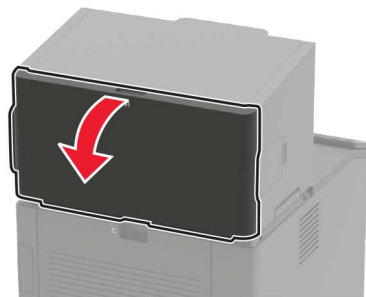

- 2 Remove the jammed paper.

**Note:** Make sure that all paper fragments are removed.



**3** Close the door.

### Paper jam in the staple finisher bin

Remove the jammed paper.

**Note:** Make sure that all paper fragments are removed.



## Paper jam in the staple, hole punch finisher

### Paper jam in door P

**1** Open door P.

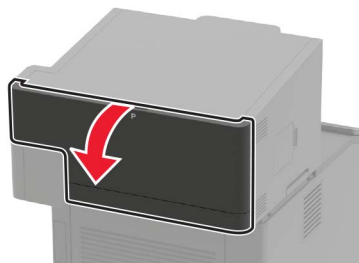

**2** Remove the jammed paper.

**Note:** Make sure that all paper fragments are removed.



**3** Close the door.

### Paper jam in the staple, hole punch finisher bin

Remove the jammed paper.

**Note:** Make sure that all paper fragments are removed.



### Staple jam in the staple finisher

**1** Open door F.

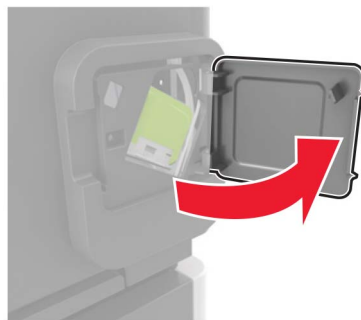



**2** Remove the staple cartridge holder.

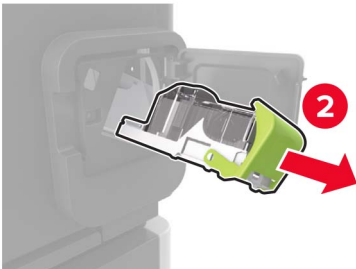
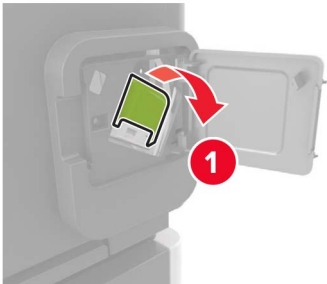

**3** Remove the loose staples.

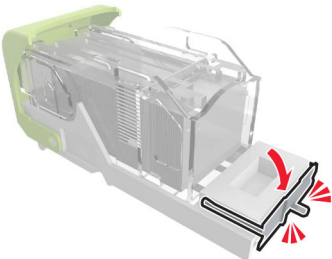
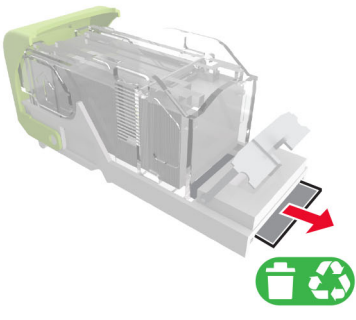
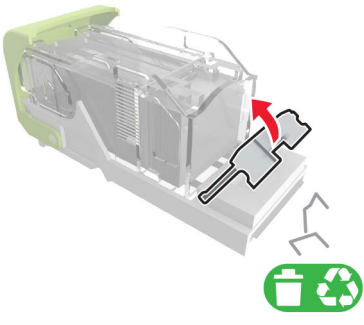

- 4 Press the staples against the metal bracket.



**Note:** If the staples are at the rear of the cartridge, then shake the cartridge downward to bring the staples near the metal bracket.

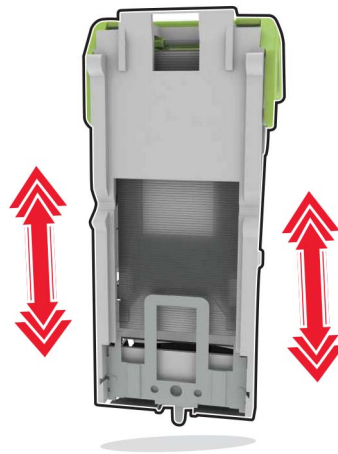

- 5 Insert the staple cartridge holder until it *clicks* into place.

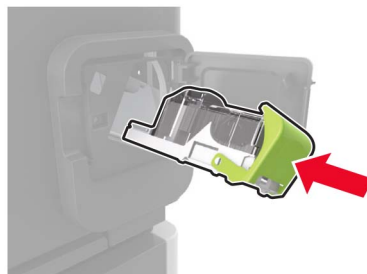

- 6 Close the door.

## Staple jam in the staple, hole punch finisher

- 1 Depending on the staple jam location, open either door F or door G.

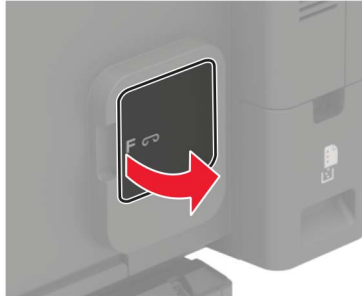

- 2 Remove the staple cartridge holder.

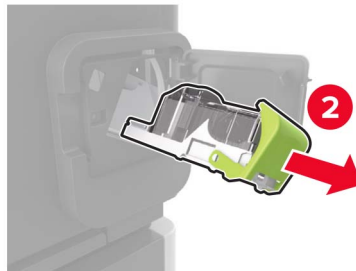
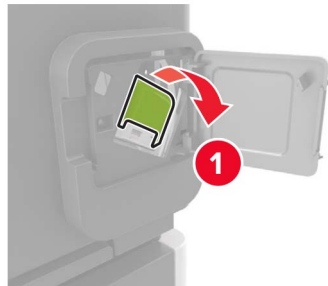

3 Remove the loose staples.

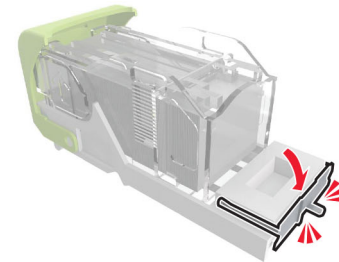
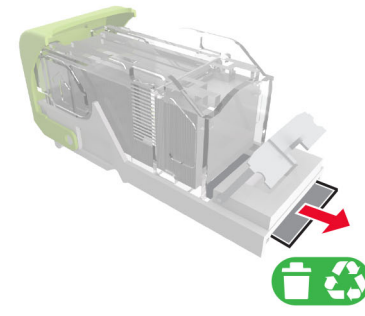
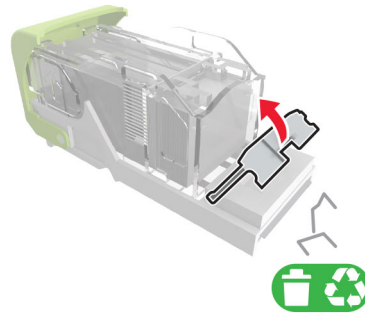

4 Press the staples against the metal bracket.



**Note:** If the staples are at the rear of the cartridge, then shake the cartridge downward to bring the staples near the metal bracket.

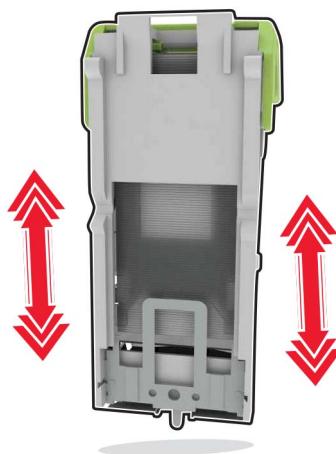

**5** Insert the staple cartridge holder until it *clicks* into place.

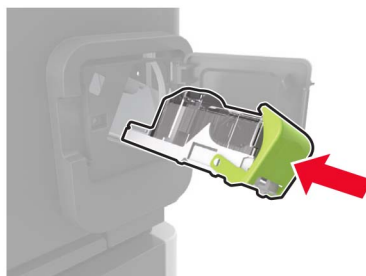

**6** Close the door.

# Troubleshooting

## Network connection problems

### Cannot open Embedded Web Server

Action	Yes	No
<p><b>Step 1</b> Check if the printer is on.</p> <p>Is the printer on?</p>	Go to step 2.	Turn on the printer.
<p><b>Step 2</b> Make sure that the printer IP address is correct.</p> <p>View the printer IP address:</p> <ul style="list-style-type: none"> <li>• From the home screen</li> <li>• From the TCP/IP section in the Network/Ports menu</li> <li>• By printing a network setup page or menu settings page, and then finding the TCP/IP section</li> </ul> <p><b>Note:</b> An IP address appears as four sets of numbers separated by periods, such as 123.123.123.123.</p> <p>Is the printer IP address correct?</p>	Go to step 3.	Type the correct printer IP address in the address field.
<p><b>Step 3</b> Check if you are using a supported browser:</p> <ul style="list-style-type: none"> <li>• Internet Explorer® version 11 or later</li> <li>• Microsoft Edge™</li> <li>• Safari version 6 or later</li> <li>• Google Chrome™ version 32 or later</li> <li>• Mozilla Firefox version 24 or later</li> </ul> <p>Is your browser supported?</p>	Go to step 4.	Install a supported browser.
<p><b>Step 4</b> Check if the network connection is working.</p> <p>Is the network connection working?</p>	Go to step 5.	Contact your administrator.
<p><b>Step 5</b> Make sure that the cable connections to the printer and print server are secure. For more information, see the documentation that came with the printer.</p> <p>Are the cable connections secure?</p>	Go to step 6.	Secure the cable connections.

Action	Yes	No
<p><b>Step 6</b> Check if the web proxy servers are disabled.</p> <p>Are the web proxy servers disabled?</p>	Go to step 7.	Contact your administrator.
<p><b>Step 7</b> Access the Embedded Web Server.</p> <p>Did the Embedded Web Server open?</p>	The problem is solved.	Contact <a href="#">customer support</a> .

## Unable to read flash drive

Action	Yes	No
<p><b>Step 1</b> Check if the printer is not busy processing another print, copy, scan, or fax job.</p> <p>Is the printer ready?</p>	Go to step 2.	Wait for the printer to finish processing the other job.
<p><b>Step 2</b> Check if the flash drive is inserted into the front USB port.</p> <p><b>Note:</b> The flash drive does not work when it is inserted into the rear USB port.</p> <p>Is the flash drive inserted into the correct port?</p>	Go to step 3.	Insert the flash drive into the correct port.
<p><b>Step 3</b> Check if the flash drive is supported. For more information, see <a href="#">“Supported flash drives and file types” on page 47</a>.</p> <p>Is the flash drive supported?</p>	Go to step 4.	Insert a supported flash drive.
<p><b>Step 4</b></p> <p><b>a</b> Check if the USB port is enabled. For more information, see <a href="#">“Enabling the USB port” on page 147</a>.</p> <p><b>b</b> Remove, and then insert the flash drive.</p> <p>Does the printer recognize the flash drive?</p>	The problem is solved.	Contact <a href="#">customer support</a> .

## Enabling the USB port

From the control panel, navigate to:

**Settings > Network/Ports > USB > Enable USB Port**

For non-touch-screen printer models, press  to navigate through the settings.

## Checking the printer connectivity

1 Print the Network Setup Page.

From the control panel, navigate to:

**Settings > Reports > Network > Network Setup Page**

For non-touch-screen printer models, press  to navigate through the settings.

2 Check the first section of the page and confirm that the status is connected.

If the status is not connected, then the LAN drop may be inactive or the network cable may be unplugged or malfunctioning. Contact your administrator for assistance.

## Hardware options problems

### Cannot detect internal option

Action	Yes	No
<p><b>Step 1</b> Turn off the printer, wait for about 10 seconds, and then turn on the printer.</p> <p>Does the internal option operate correctly?</p>	The problem is solved.	Go to step 2.
<p><b>Step 2</b> Print the Menu Settings Page, and then check if the internal option appears in the Installed Features list.</p> <p>Is the internal option listed in the menu settings page?</p>	Go to step 4.	Go to step 3.
<p><b>Step 3</b> Check if the internal option is installed properly into the controller board.</p> <ul style="list-style-type: none"> <li><b>a</b> Turn off the printer, and then unplug the power cord from the electrical outlet.</li> <li><b>b</b> Make sure that the internal option is installed in the appropriate connector in the controller board.</li> <li><b>c</b> Connect the power cord to the electrical outlet, and then turn on the printer.</li> </ul> <p> <b>CAUTION—POTENTIAL INJURY:</b> To avoid the risk of fire or electrical shock, connect the power cord to an appropriately rated and properly grounded electrical outlet that is near the product and easily accessible.</p> <p>Does the internal option operate correctly?</p>	The problem is solved.	Go to step 4.



Action	Yes	No
<p><b>Step 4</b></p> <p><b>a</b> Check if the internal option is available in the print driver.</p> <p><b>Note:</b> If necessary, manually add the internal option in the print driver to make it available for print jobs. For more information, see <a href="#">“Adding available options in the print driver” on page 208.</a></p> <p><b>b</b> Resend the print job.</p> <p>Does the internal option operate correctly?</p>	<p>The problem is solved.</p>	<p>Contact <a href="#">customer support.</a></p>

## Defective flash detected

Try one or more of the following:

- Replace the defective flash memory.
- From the printer control panel, select **Continue** to ignore the message and continue printing.
- Cancel the current print job.

## Not enough free space in flash memory for resources

Try one or more of the following:

- From the printer control panel, select **Continue** to clear the message and continue printing.
- Delete fonts, macros, and other data stored in the flash memory.
- Install flash memory with larger capacity.

**Note:** Downloaded fonts and macros that are not previously stored in the flash memory are deleted.

## Unformatted flash detected

Try one or more of the following:

- From the control panel, select **Continue** to stop the defragmentation and continue printing.
- Format the flash memory.

**Note:** If the error message remains, then the flash memory may be defective and needs to be replaced.

## Issues with supplies

### Replace cartridge, printer region mismatch

To correct this problem, purchase a cartridge with the correct region that matches the printer region, or purchase a worldwide cartridge.

- The first number in the message after 42 indicates the region of the printer.
- The second number in the message after 42 indicates the region of the cartridge.

### Printer and toner cartridge regions

Region	Numeric code
Worldwide or Undefined region	0
North America (United States, Canada)	1
European Economic Area, Western Europe, Nordic countries, Switzerland	2
Asia Pacific	3
Latin America	4
Rest of Europe, Middle East, Africa	5
Australia, New Zealand	6
Invalid region	9

**Note:** To find the region settings of the printer and toner cartridge, print the print quality test pages. From the control panel, navigate to: **Settings > Troubleshooting > Print Quality Test Pages.**

### Non-Lexmark supply

The printer has detected a non-Lexmark supply or part installed in the printer.

Your Lexmark printer is designed to function best with genuine Lexmark supplies and parts. Use of third-party supplies or parts may affect the performance, reliability, or life of the printer and its imaging components.

All life indicators are designed to function with Lexmark supplies and parts and may deliver unpredictable results if third-party supplies or parts are used. Imaging component usage beyond the intended life may damage your Lexmark printer or associated components.

**Warning—Potential Damage:** Use of third-party supplies or parts can affect warranty coverage. Damage caused by the use of third-party supplies or parts may not be covered by the warranty.

To accept any and all of these risks and to proceed with the use of non-genuine supplies or parts in your printer, depending on your printer model, from the control panel, press and hold **X** and **#**, or **X** and **OK**, simultaneously for 15 seconds.

If you do not want to accept these risks, then remove the third-party supply or part from your printer and install a genuine Lexmark supply or part. For more information, see [“Using genuine Lexmark parts and supplies” on page 101.](#)

If the printer does not print after pressing and holding **X** and **#**, or **X** and **OK**, simultaneously for 15 seconds, then reset the supply usage counter.

- From the control panel, navigate to:  
**Settings > Device > Maintenance > Configuration Menu > Supply Usage And Counters**

For non-touch-screen printer models, press **OK** to navigate through the settings.

- Select the part or supply that you want to reset, and then select **Start**.

**3** Read the warning message, and then select **Continue**.

**4** Press and hold **X** and **#**, or **X** and **OK**, simultaneously for 15 seconds to clear the message.

**Note:** If you are unable to reset the supply usage counters, then return the item to the place of purchase.

## Paper feed problems

### Envelope seals when printing

Action	Yes	No
<p><b>Step 1</b></p> <p><b>a</b> Use an envelope that has been stored in a dry environment.  <b>Note:</b> Printing on envelopes with high moisture content can seal the flaps.</p> <p><b>b</b> Send the print job.</p> <p>Does the envelope seal when printing?</p>	Go to step 2.	The problem is solved.
<p><b>Step 2</b></p> <p><b>a</b> Make sure that paper type is set to Envelope.            From the control panel, navigate to:  <b>Settings &gt; Paper &gt; Tray Configuration &gt; Paper Size/Type</b></p> <p>For non-touch-screen printer models, press <b>OK</b> to navigate through the settings.</p> <p><b>b</b> Send the print job.</p> <p>Does the envelope seal when printing?</p>	Contact <a href="#">customer support</a> .	The problem is solved.

### Collated printing does not work

Action	Yes	No
<p><b>Step 1</b></p> <p><b>a</b> From the printer control panel, navigate to:  <b>Settings &gt; Print &gt; Layout &gt; Collate</b></p> <p>For non-touch-screen printer models, press <b>OK</b> to navigate through the settings.</p> <p><b>b</b> Set Collate to <b>On</b>.</p> <p><b>c</b> Print the document.</p> <p>Are the pages collated correctly?</p>	The problem is solved.	Go to step 2.

Action	Yes	No
<p><b>Step 2</b></p> <p><b>a</b> From the document that you are trying to print, open the Print dialog, and then select <b>Collate</b>.</p> <p><b>b</b> Print the document.</p> <p>Are the pages collated correctly?</p>	The problem is solved.	Go to step 3.
<p><b>Step 3</b></p> <p><b>a</b> Reduce the number of pages to print.</p> <p><b>b</b> Print the document.</p> <p>Are the pages collated correctly?</p>	The problem is solved.	Contact <a href="#">customer support</a> .

### Tray linking does not work

Action	Yes	No
<p><b>Step 1</b></p> <p><b>a</b> Check if the trays contain the same paper size and paper type.</p> <p><b>b</b> Check if the paper guides are positioned correctly.</p> <p><b>c</b> Print the document.</p> <p>Do the trays link correctly?</p>	The problem is solved.	Go to step 2.
<p><b>Step 2</b></p> <p><b>a</b> From the control panel, navigate to:  <b>Settings &gt; Paper &gt; Tray Configuration &gt; Paper Size/Type</b></p> <p>For non-touch-screen printer models, press  to navigate through the settings.</p> <p><b>b</b> Set the paper size and paper type to match the paper loaded in the linked trays.</p> <p><b>c</b> Print the document.</p> <p>Do the trays link correctly?</p>	The problem is solved.	Go to step 3.
<p><b>Step 3</b></p> <p><b>a</b> Make sure that Tray Linking is set to Automatic. For more information, see <a href="#">“Linking trays” on page 36</a>.</p> <p><b>b</b> Print the document.</p> <p>Do the trays link correctly?</p>	The problem is solved.	Contact <a href="#">customer support</a> .

## Paper frequently jams

Action	Yes	No
<p><b>Step 1</b></p> <p><b>a</b> Remove the tray.</p> <p><b>b</b> Check if paper is loaded correctly.</p> <p><b>Notes:</b></p> <ul style="list-style-type: none"> <li>• Make sure that the paper guides are positioned correctly.</li> <li>• Make sure that the stack height is below the maximum paper fill indicator.</li> <li>• Make sure to print on recommended paper size and type.</li> </ul> <p><b>c</b> Insert the tray.</p> <p><b>d</b> Print the document.</p> <p>Do paper jams occur frequently?</p>	Go to step 2.	The problem is solved.
<p><b>Step 2</b></p> <p><b>a</b> From the control panel, navigate to:  <b>Settings &gt; Paper &gt; Tray Configuration &gt; Paper Size/Type</b></p> <p>For non-touch-screen printer models, press  to navigate through the settings.</p> <p><b>b</b> Set the correct paper size and type.</p> <p><b>c</b> Print the document.</p> <p>Do paper jams occur frequently?</p>	Go to step 3.	The problem is solved.
<p><b>Step 3</b></p> <p><b>a</b> Load paper from a fresh package.</p> <p><b>Note:</b> Paper absorbs moisture due to high humidity. Store paper in its original wrapper until you are ready to use it.</p> <p><b>b</b> Print the document.</p> <p>Do paper jams occur frequently?</p>	Contact <a href="#">customer support</a> .	The problem is solved.

## Jammed pages are not reprinted

Action	Yes	No
<p><b>a</b> From the control panel, navigate to:  <b>Settings &gt; Device &gt; Notifications &gt; Jam Content Recovery</b></p> <p>For non-touch-screen printer models, press  to navigate through the settings.</p> <p><b>b</b> Select <b>On</b> or <b>Auto</b>, and then apply the changes.</p> <p><b>c</b> Print the document.</p> <p>Are the jammed pages reprinted?</p>	<p>The problem is solved.</p>	<p>Contact <a href="#">customer support</a>.</p>

## Printing problems

### Print quality is poor

#### Blank or white pages



**Note:** Before solving the problem, print the Print Quality Test Pages. From the control panel, navigate to **Settings > Troubleshooting > Print Quality Test Pages**. For non-touch-screen printer models, press  to navigate through the settings.

Action	Yes	No
<p><b>Step 1</b></p> <p><b>a</b> Check if the printer is using a genuine and supported Lexmark toner cartridge.</p> <p><b>Note:</b> If the cartridge is not supported, then install a supported one.</p> <p><b>b</b> Print the document.</p> <p>Is the printer printing blank or white pages?</p>	<p>Go to step 2.</p>	<p>The problem is solved.</p>

Action	Yes	No
<p><b>Step 2</b></p> <p><b>a</b> Remove any packing material that is left on the imaging unit.</p> <p><b>1</b> Remove the toner cartridge, and then remove the imaging unit.</p> <p><b>Warning—Potential Damage:</b> Do not expose the imaging unit to direct light for more than 10 minutes. Extended exposure to light may cause print quality problems.</p> <p><b>Warning—Potential Damage:</b> Do not touch the photoconductor drum under the imaging unit. Doing so may affect the quality of future print jobs.</p> <p><b>2</b> Check the imaging unit for signs of damage.</p> <p><b>Note:</b> Make sure that the photoconductor drum contact is not bent or out of place.</p> <p><b>3</b> Firmly shake the imaging unit to redistribute the toner.</p> <p><b>4</b> Insert the imaging unit, and then insert the toner cartridge.</p> <p><b>b</b> Print the document.</p> <p>Is the printer printing blank or white pages?</p>	Go to step 3.	The problem is solved.
<p><b>Step 3</b></p> <p>Check the status of the toner cartridge, and replace if necessary.</p> <p><b>a</b> From the control panel, navigate to <b>Status/Supplies &gt; Supplies</b></p> <p><b>b</b> Print the document.</p> <p>Is the printer printing blank or white pages?</p>	Go to step 4.	The problem is solved.
<p><b>Step 4</b></p> <p>Check the transfer roller for proper installation.</p> <p>Is the transfer roller installed properly?</p>	Contact <a href="#">customer support</a> .	Go to step 5.
<p><b>Step 5</b></p> <p><b>a</b> Remove, and then insert the transfer roller.</p> <p><b>b</b> Print the document.</p> <p>Is the printer printing blank or white pages?</p>	Contact <a href="#">customer support</a> .	The problem is solved.

**Dark print**



**Note:** Before solving the problem, print the Print Quality Test Pages. From the control panel, navigate to **Settings > Troubleshooting > Print Quality Test Pages**. For non-touch-screen printer models, press  to navigate through the settings.

Action	Yes	No
<p><b>Step 1</b></p> <p><b>a</b> Check if the printer is using a genuine and supported Lexmark toner cartridge.</p> <p><b>Note:</b> If the cartridge is not supported, then install a supported one.</p> <p><b>b</b> Print the document.</p> <p>Is the print dark?</p>	Go to step 2.	The problem is solved.
<p><b>Step 2</b></p> <p><b>a</b> Turn off the printer, wait for about 10 seconds, and then turn on the printer.</p> <p><b>b</b> Reduce toner darkness. From the control panel, navigate to: <b>Settings &gt; Print &gt; Quality</b></p> <p><b>c</b> Print the document.</p> <p>Is the print dark?</p>	Go to step 3.	The problem is solved.
<p><b>Step 3</b></p> <p><b>a</b> Depending on your operating system, specify the paper type from the Printing Preferences or Print dialog.</p> <p><b>Notes:</b></p> <ul style="list-style-type: none"> <li>• Make sure that the setting matches the paper loaded.</li> <li>• You can also change the setting on the printer control panel.</li> </ul> <p><b>b</b> Print the document.</p> <p>Is the print dark?</p>	Go to step 4.	The problem is solved.
<p><b>Step 4</b></p> <p>Check if the paper has texture or rough finishes.</p> <p>Are you printing on textured or rough paper?</p>	Go to step 5.	Go to step 6.
<p><b>Step 5</b></p> <p><b>a</b> Replace textured paper with plain paper.</p> <p><b>b</b> Print the document.</p> <p>Is the print dark?</p>	Go to step 6.	The problem is solved.



Action	Yes	No
<p><b>Step 6</b></p> <p><b>a</b> Load paper from a fresh package.</p> <p><b>Note:</b> Paper absorbs moisture due to high humidity. Store paper in its original wrapper until you are ready to use it.</p> <p><b>b</b> Print the document.</p> <p>Is the print dark?</p>	Go to step 7.	The problem is solved.
<p><b>Step 7</b></p> <p><b>a</b> Remove, and then insert the imaging unit.</p> <p><b>Warning—Potential Damage:</b> Do not expose the imaging unit to direct light for more than 10 minutes. Extended exposure to light may cause print quality problems.</p> <p><b>Warning—Potential Damage:</b> Do not touch the photoconductor drum under the imaging unit. Doing so may affect the quality of future print jobs.</p> <p><b>b</b> Print the document.</p> <p>Is the print dark?</p>	Go to step 8.	The problem is solved.
<p><b>Step 8</b></p> <p><b>a</b> Replace the imaging unit.</p> <p><b>b</b> Print the document.</p> <p>Is the print dark?</p>	Contact <a href="#">customer support</a> .	The problem is solved.

### Fine lines are not printed correctly

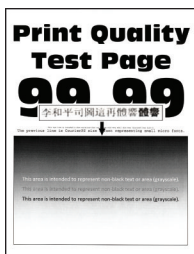

**Note:** Before solving the problem, print the Print Quality Test Pages. From the control panel, navigate to **Settings > Troubleshooting > Print Quality Test Pages**. For non-touch-screen printer models, press  to navigate through the settings.

Action	Yes	No
<p><b>Step 1</b></p> <p><b>a</b> Check if the printer is using a genuine and supported Lexmark toner cartridge.</p> <p><b>Note:</b> If the cartridge is not supported, then install a supported one.</p> <p><b>b</b> Print the document.</p> <p>Are fine lines not printed correctly?</p>	Go to step 2.	The problem is solved.
<p><b>Step 2</b></p> <p><b>a</b> Adjust the print quality settings.</p> <p>1 From the control panel, navigate to: <b>Settings &gt; Print &gt; Quality &gt; Pixel Boost &gt; Fonts</b></p> <p>2 Adjust Toner Darkness to 7. From the control panel, navigate to: <b>Settings &gt; Print &gt; Quality</b></p> <p><b>b</b> Print the document.</p> <p>Are fine lines not printed correctly?</p>	Contact <a href="#">customer support</a> .	The problem is solved.

### Folded or wrinkled paper

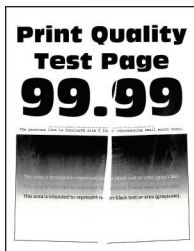



**Note:** Before solving the problem, print the Print Quality Test Pages. From the control panel, navigate to **Settings > Troubleshooting > Print Quality Test Pages**. For non-touch-screen printer models, press **OK** to navigate through the settings.

Action	Yes	No
<p><b>Step 1</b></p> <p><b>a</b> Check if the printer is using a genuine and supported Lexmark toner cartridge.</p> <p><b>Note:</b> If the cartridge is not supported, then install a supported one.</p> <p><b>b</b> Print the document.</p> <p>Is the paper folded or wrinkled?</p>	Go to step 2.	The problem is solved.

Action	Yes	No
<p><b>Step 2</b></p> <p><b>a</b> Load paper from a fresh package.</p> <p><b>Note:</b> Paper absorbs moisture due to high humidity. Store paper in its original wrapper until you are ready to use it.</p> <p><b>b</b> Print the document.</p> <p>Is the paper folded or wrinkled?</p>	Go to step 3.	The problem is solved.
<p><b>Step 3</b></p> <p><b>a</b> Depending on your operating system, specify the paper type from the Printing Preferences or Print dialog.</p> <p><b>Notes:</b></p> <ul style="list-style-type: none"> <li>• Make sure that the setting matches the paper loaded.</li> <li>• You can also change the setting from the printer control panel.</li> </ul> <p><b>b</b> Print the document.</p> <p>Is the paper folded or wrinkled?</p>	Contact <a href="#">customer support</a> .	The problem is solved.

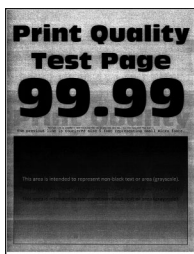
**Gray background**



**Note:** Before solving the problem, print the Print Quality Test Pages. From the control panel, navigate to **Settings > Troubleshooting > Print Quality Test Pages**. For non-touch-screen printer models, press  to navigate through the settings.

Action	Yes	No
<p><b>Step 1</b></p> <p><b>a</b> Turn off the printer, wait for 10 seconds, and then turn on the printer.</p> <p><b>b</b> Increase toner darkness.</p> <p>From the control panel, navigate to:</p> <p><b>Settings &gt; Print &gt; Quality</b></p> <p><b>c</b> Print the document.</p> <p>Does gray background appear on prints?</p>	Go to step 2.	The problem is solved.

Action	Yes	No
<p><b>Step 2</b></p> <p><b>a</b> Check if the printer is using a genuine and supported Lexmark toner cartridge.</p> <p><b>Note:</b> If the toner cartridge is not supported, then install a supported one.</p> <p><b>b</b> Print the document.</p> <p>Does gray background appear on prints?</p>	Go to step 3.	The problem is solved.
<p><b>Step 3</b></p> <p><b>a</b> Depending on your operating system, specify the paper type from the Printing Preferences or Print dialog.</p> <p><b>Notes:</b></p> <ul style="list-style-type: none"> <li>• Make sure that the setting matches the paper loaded.</li> <li>• You can also change the setting from the printer control panel.</li> </ul> <p><b>b</b> Print the document.</p> <p>Does gray background appear on prints?</p>	Go to step 4.	The problem is solved.
<p><b>Step 4</b></p> <p>Check the status of the toner cartridge, and replace if necessary.</p> <p><b>a</b> From the control panel, navigate to:</p> <p><b>Status/Supplies &gt; Supplies</b></p> <p><b>b</b> Print the document.</p> <p>Does gray background appear on prints?</p>	Go to step 5.	The problem is solved.
<p><b>Step 5</b></p> <p>Check if the imaging unit serial number has 12, 13, or 14 in the fourth and fifth digits. For example, CAS13xxxxxx.</p> <p>Does the serial number have 12, 13, or 14 in the fourth and fifth digits?</p>	Go to step 6.	Contact <a href="#">customer support</a> .

Action	Yes	No
<p><b>Step 6</b></p> <p><b>a</b> Remove the imaging unit.</p> <p><b>Warning—Potential Damage:</b> Do not expose the imaging unit to direct light for more than 10 minutes. Extended exposure to light may cause print quality problems.</p> <p><b>Warning—Potential Damage:</b> Do not touch the photoconductor drum under the imaging unit. Doing so may affect the quality of future print jobs.</p> <p><b>b</b> Remove any packing material that is stuck on the imaging unit.</p> <div data-bbox="402 625 781 1178" style="text-align: center;"> </div> <p><b>Note:</b> Make sure to remove any obstruction between the charge roller and photoconductor drum.</p> <p><b>c</b> Insert the imaging unit.</p> <p><b>d</b> Print the document.</p> <p>Does gray background appear on prints?</p>	<p>Go to step 7.</p>	<p>The problem is solved.</p>
<p><b>Step 7</b></p> <p><b>a</b> Replace the imaging unit.</p> <p><b>b</b> Print the document.</p> <p>Does gray background appear on prints?</p>	<p>Contact <a href="#">customer support</a>.</p>	<p>The problem is solved.</p>

### Incorrect margins



Action	Yes	No
<p><b>Step 1</b></p> <p><b>a</b> Adjust the paper guides to the correct position for the paper loaded.</p> <p><b>b</b> Print the document.</p> <p>Are the margins correct?</p>	<p>The problem is solved.</p>	<p>Go to step 2.</p>
<p><b>Step 2</b></p> <p><b>a</b> Depending on your operating system, specify the paper size from the Printing Preferences or Print dialog.</p> <p><b>Notes:</b></p> <ul style="list-style-type: none"> <li>• Make sure that the setting matches the paper loaded.</li> <li>• You can also change the setting from the printer control panel.</li> </ul> <p><b>b</b> Print the document.</p> <p>Are the margins correct?</p>	<p>The problem is solved.</p>	<p>Contact <a href="#">customer support</a>.</p>

### Light print

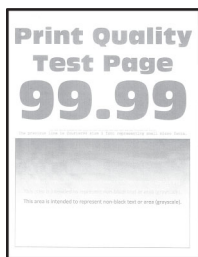

**Note:** Before solving the problem, print the Print Quality Test Pages. From the control panel, navigate to **Settings > Troubleshooting > Print Quality Test Pages**. For non-touch-screen printer models, press  to navigate through the settings.

Action	Yes	No
<p><b>Step 1</b></p> <p><b>a</b> Check if the printer is using a genuine and supported Lexmark toner cartridge.</p> <p><b>Note:</b> If the cartridge is not supported, then install a supported one.</p> <p><b>b</b> Print the document.</p> <p>Is the print light?</p>	<p>Go to step 2.</p>	<p>The problem is solved.</p>
<p><b>Step 2</b></p> <p><b>a</b> Turn off the printer, wait for about 10 seconds, and then turn on the printer.</p> <p><b>b</b> Increase toner darkness. From the control panel, navigate to: <b>Settings &gt; Print &gt; Quality</b></p> <p><b>c</b> Print the document.</p> <p>Is the print light?</p>	<p>Go to step 3.</p>	<p>The problem is solved.</p>
<p><b>Step 3</b></p> <p><b>a</b> Depending on your operating system, specify the paper type from the Printing Preferences or Print dialog.</p> <p><b>Notes:</b></p> <ul style="list-style-type: none"> <li>• Make sure that the setting matches the paper loaded.</li> <li>• You can also change the setting on the printer control panel.</li> </ul> <p><b>b</b> Print the document.</p> <p>Is the print light?</p>	<p>Go to step 4.</p>	<p>The problem is solved.</p>
<p><b>Step 4</b></p> <p>Check the status of the toner cartridge, and replace if necessary.</p> <p><b>a</b> From the control panel, navigate to: <b>Status/Supplies &gt; Supplies</b></p> <p><b>b</b> Print the document.</p> <p>Is the print light?</p>	<p>Go to step 5.</p>	<p>The problem is solved.</p>

Action	Yes	No
<p><b>Step 5</b></p> <p><b>a</b> Remove the toner cartridge, and then remove the imaging unit.</p> <p><b>Warning—Potential Damage:</b> Do not expose the imaging unit to direct light for more than 10 minutes. Extended exposure to light can cause print quality problems.</p> <p><b>Warning—Potential Damage:</b> Do not touch the photoconductor drum under the imaging unit. Doing so may affect the quality of future print jobs.</p> <p><b>b</b> Push either side of the transfer roller, located below the imaging unit, to check if it depresses and bounces back into place.</p> <p><b>c</b> If the transfer roller does not depress and bounce back into place, then insert it by pulling up the blue gear and pulling it out from the right side to the left.</p> <p><b>d</b> Firmly shake the imaging unit to redistribute the toner, and then insert it.</p> <p><b>e</b> Insert the toner cartridge.</p> <p><b>f</b> Turn off the printer, wait for 10 seconds, and then turn on the printer.</p> <p><b>g</b> Print the document.</p> <p>Is the print light?</p>	<p>Go to step 6.</p>	<p>The problem is solved.</p>
<p><b>Step 6</b></p> <p><b>a</b> If the issue happens after installing a new maintenance kit, then check whether the transfer roller included with the kit is installed.</p> <p><b>Note:</b> If necessary, replace the transfer roller.</p> <p><b>b</b> Print the document.</p> <p>Is the print light?</p>	<p>Go to step 7.</p>	<p>The problem is solved.</p>
<p><b>Step 7</b></p> <p>Check the status of the imaging unit. From the control panel, navigate to:</p> <p><b>Status/Supplies &gt; Supplies</b></p> <p>Is the imaging unit near end of life?</p>	<p>Go to step 8.</p>	<p>Contact <a href="#">customer support</a>.</p>
<p><b>Step 8</b></p> <p><b>a</b> Replace the imaging unit.</p> <p><b>b</b> Print the document.</p> <p>Is the print light?</p>	<p>Contact <a href="#">customer support</a>.</p>	<p>The problem is solved.</p>



### Mottled print and dots



**Note:** Before solving the problem, print the Print Quality Test Pages. From the control panel, navigate to **Settings > Troubleshooting > Print Quality Test Pages**. For non-touch-screen printer models, press **OK** to navigate through the settings.

Action	Yes	No
<p><b>Step 1</b></p> <p><b>a</b> Check if the printer is using a genuine and supported Lexmark toner cartridge.</p> <p><b>Note:</b> If the cartridge is not supported, then install a supported one.</p> <p><b>b</b> Print the document.</p> <p>Is the print mottled?</p>	Go to step 2.	The problem is solved.
<p><b>Step 2</b></p> <p>Check the printer for leaked toner contamination.</p> <p>Is the printer free of leaked toner?</p>	Go to step 4.	Go to step 3.
<p><b>Step 3</b></p> <p><b>a</b> Replace the toner cartridge.</p> <p><b>b</b> Print the document.</p> <p>Is the print mottled?</p>	Go to step 4.	The problem is solved.
<p><b>Step 4</b></p> <p>Check if the mottled print only appears on the edges or back side of the pages.</p> <p>Is the print mottled only on the edges or back side of the pages?</p>	Go to step 5.	Go to step 6.
<p><b>Step 5</b></p> <p><b>a</b> Replace the transfer roller.</p> <p><b>b</b> Print the document.</p> <p>Is the print mottled?</p>	Go to step 6.	The problem is solved.

Action	Yes	No
<p><b>Step 6</b></p> <p>Check the status of the imaging unit. From the control panel, navigate to:</p> <p><b>Status/Supplies &gt; Supplies</b></p> <p>Is the imaging unit near end of life?</p>	Go to step 7.	Contact <a href="#">customer support</a> .
<p><b>Step 7</b></p> <p><b>a</b> Replace the imaging unit.</p> <p><b>b</b> Print the document.</p> <p>Is the print mottled?</p>	Contact <a href="#">customer support</a> .	The problem is solved.

### Paper curl



**Note:** Before solving the problem, print the Print Quality Test Pages. From the control panel, navigate to **Settings > Troubleshooting > Print Quality Test Pages**. For non-touch-screen printer models, press **OK** to navigate through the settings.

Action	Yes	No
<p><b>Step 1</b></p> <p><b>a</b> Check if the printer is using a genuine and supported Lexmark toner cartridge.</p> <p><b>Note:</b> If the cartridge is not supported, then install a supported one.</p> <p><b>b</b> Print the document.</p> <p>Is the paper curled?</p>	Go to step 2.	The problem is solved.
<p><b>Step 2</b></p> <p><b>a</b> Adjust the guides in the tray to the correct position for the paper loaded.</p> <p><b>b</b> Print the document.</p> <p>Is the paper curled?</p>	Go to step 3.	The problem is solved.

Action	Yes	No
<p><b>Step 3</b></p> <p><b>a</b> Depending on your operating system, specify the paper size and paper type from the Printing Preferences or Print dialog.</p> <p><b>Notes:</b></p> <ul style="list-style-type: none"> <li>• Make sure that the settings match the paper loaded.</li> <li>• You can also change the settings from the printer control panel.</li> </ul> <p><b>b</b> Print the document.</p> <p>Is the paper curled?</p>	Go to step 4.	The problem is solved.
<p><b>Step 4</b></p> <p><b>a</b> Remove paper from the tray, and then turn over the paper.</p> <p><b>b</b> Print the document.</p> <p>Is the paper curled?</p>	Go to step 5.	The problem is solved.
<p><b>Step 5</b></p> <p><b>a</b> Load paper from a fresh package.</p> <p><b>Note:</b> Paper absorbs moisture due to high humidity. Store paper in its original wrapper until you are ready to use it.</p> <p><b>b</b> Print the document.</p> <p>Is the paper curled?</p>	Go to step 6.	The problem is solved.
<p><b>Step 6</b></p> <p><b>a</b> Check if the paper loaded is supported.</p> <p><b>Note:</b> If paper is not supported, then load a supported paper.</p> <p><b>b</b> Print the document.</p> <p>Is the paper curled?</p>	Contact <a href="#">customer support</a> .	The problem is solved.

### Print crooked or skewed



**Note:** Before solving the problem, print the Print Quality Test Pages. From the control panel, navigate to **Settings > Troubleshooting > Print Quality Test Pages**. For non-touch-screen printer models, press  to navigate through the settings.

Action	Yes	No
<p><b>Step 1</b></p> <p><b>a</b> Adjust the guides in the tray to the correct position for the paper loaded.</p> <p><b>b</b> Print the document.</p> <p>Is the print crooked or skewed?</p>	Go to step 2.	The problem is solved.
<p><b>Step 2</b></p> <p><b>a</b> Check if the paper loaded is supported. <b>Note:</b> If paper is not supported, then load a supported paper.</p> <p><b>b</b> Print the document.</p> <p>Is the print crooked or skewed?</p>	Go to step 3.	The problem is solved.
<p><b>Step 3</b></p> <p><b>a</b> Check the pick tire in the tray for signs of damage and contamination, and replace if necessary.</p> <p><b>b</b> Print the document.</p> <p>Is the print crooked or skewed?</p>	Contact <a href="#">customer support</a> .	The problem is solved.

**Solid black pages**



**Note:** Before solving the problem, print the Print Quality Test Pages. From the control panel, navigate to **Settings > Troubleshooting > Print Quality Test Pages**. For non-touch-screen printer models, press  to navigate through the settings.

Action	Yes	No
<p><b>Step 1</b></p> <p><b>a</b> Check if the printer is using a genuine and supported Lexmark toner cartridge. <b>Note:</b> If the toner cartridge is not supported, then install a supported one.</p> <p><b>b</b> Print the document.</p> <p>Is the printer printing solid black pages?</p>	Go to step 2.	The problem is solved.

Action	Yes	No
<p><b>Step 2</b></p> <p><b>a</b> Remove, and then insert the imaging unit.</p> <p><b>Warning—Potential Damage:</b> Do not expose the imaging unit to direct light for more than 10 minutes. Extended exposure to light may cause print quality problems.</p> <p><b>Warning—Potential Damage:</b> Do not touch the photoconductor drum under the imaging unit. Doing so may affect the quality of future print jobs.</p> <p><b>b</b> Print the document.</p> <p>Is the printer printing solid black pages?</p>	<p>Go to step 3.</p>	<p>The problem is solved.</p>
<p><b>Step 3</b></p> <p><b>a</b> Remove the imaging unit.</p> <p><b>Warning—Potential Damage:</b> Do not expose the imaging unit to direct light for more than 10 minutes. Extended exposure to light may cause print quality problems.</p> <p><b>Warning—Potential Damage:</b> Do not touch the photoconductor drum under the imaging unit. Doing so may affect the quality of future print jobs.</p> <p><b>b</b> Remove any packing material that is stuck on the imaging unit.</p> <div data-bbox="402 1045 776 1591" style="text-align: center;"> </div> <p><b>Note:</b> Make sure to remove any obstruction between the charge roller and photoconductor drum.</p> <p><b>c</b> Insert the imaging unit.</p> <p><b>d</b> Print the document.</p> <p>Is the printer printing solid black pages?</p>	<p>Go to step 4.</p>	<p>The problem is solved.</p>

Action	Yes	No
<p><b>Step 4</b> Check the imaging unit for signs of damage.</p> <p>Is the imaging unit free from damage?</p>	Contact <a href="#">customer support</a> .	Go to step 5.
<p><b>Step 5</b>                      a Replace the imaging unit.                      b Print the document.</p> <p>Is the printer printing solid black pages?</p>	Contact <a href="#">customer support</a> .	The problem is solved.

**Text or images cut off**

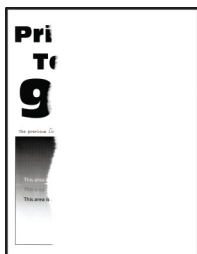

**Note:** Before solving the problem, print the Print Quality Test Pages. From the control panel, navigate to **Settings > Troubleshooting > Print Quality Test Pages**. For non-touch-screen printer models, press **OK** to navigate through the settings.

Action	Yes	No
<p><b>Step 1</b>                      a Check if the printer is using a genuine and supported Lexmark toner cartridge.  <b>Note:</b> If the toner cartridge is not supported, then install a supported one.                      b Print the document.</p> <p>Are text or images cut off?</p>	Go to step 2.	The problem is solved.
<p><b>Step 2</b>                      a Remove, and then insert the imaging unit.  <b>Warning—Potential Damage:</b> Do not expose the imaging unit to direct light for more than 10 minutes. Extended exposure to light may cause print quality problems.  <b>Warning—Potential Damage:</b> Do not touch the photoconductor drum under the imaging unit. Doing so may affect the quality of future print jobs.                      b Print the document.</p> <p>Are text or images cut off?</p>	Go to step 3.	The problem is solved.

Action	Yes	No
<p><b>Step 3</b></p> <p><b>a</b> Remove the imaging unit.</p> <p><b>Warning—Potential Damage:</b> Do not expose the imaging unit to direct light for more than 10 minutes. Extended exposure to light may cause print quality problems.</p> <p><b>Warning—Potential Damage:</b> Do not touch the photoconductor drum under the imaging unit. Doing so may affect the quality of future print jobs.</p> <p><b>b</b> Remove any packing material that is stuck on the imaging unit.</p> <div data-bbox="402 625 781 1178" style="text-align: center;"> </div> <p><b>Note:</b> Make sure to remove any obstruction between the charge roller and photoconductor drum.</p> <p><b>c</b> Insert the imaging unit.</p> <p><b>d</b> Print the document.</p> <p>Are text or images cut off?</p>	<p>Go to step 4.</p>	<p>The problem is solved.</p>
<p><b>Step 4</b></p> <p><b>a</b> Replace the imaging unit.</p> <p><b>b</b> Print the document.</p> <p>Are text or images cut off?</p>	<p>Contact <a href="#">customer support</a>.</p>	<p>The problem is solved.</p>

### Toner easily rubs off



**Note:** Before solving the problem, print the Print Quality Test Pages. From the control panel, navigate to **Settings > Troubleshooting > Print Quality Test Pages**. For non-touch-screen printer models, press **OK** to navigate through the settings.

Action	Yes	No
<p><b>Step 1</b></p> <p><b>a</b> Check if the printer is using a genuine and supported Lexmark toner cartridge.</p> <p><b>Note:</b> If the cartridge is not supported, then install a supported one.</p> <p><b>b</b> Print the document.</p> <p>Does toner easily rub off?</p>	Go to step 2.	The problem is solved.
<p><b>Step 2</b></p> <p><b>a</b> Depending on your operating system, specify the paper type from the Printing Preferences or Print dialog.</p> <p><b>Notes:</b></p> <ul style="list-style-type: none"> <li>• Make sure that the setting matches the paper loaded.</li> <li>• You can also change the setting on the printer control panel.</li> </ul> <p><b>b</b> Print the document.</p> <p>Does toner easily rub off?</p>	Go to step 3.	The problem is solved.
<p><b>Step 3</b></p> <p><b>a</b> Remove, and then insert the fuser.</p> <p><b>b</b> Print the document.</p> <p>Does toner easily rub off?</p>	Contact <a href="#">customer support</a> .	The problem is solved.



### Horizontal light bands



**Note:** Before solving the problem, print the Print Quality Test Pages. From the control panel, navigate to **Settings > Troubleshooting > Print Quality Test Pages**. For non-touch-screen printer models, press **OK** to navigate through the settings.

Action	Yes	No
<p><b>a</b> Check if the printer is using a genuine and supported Lexmark toner cartridge.</p> <p><b>Note:</b> If the cartridge is not supported, then install a supported one.</p> <p><b>b</b> Print the document.</p> <p>Do horizontal light bands appear on prints?</p>	<p>Contact <a href="#">customer support</a>.</p>	<p>The problem is solved.</p>

### Vertical light bands



**Note:** Before solving the problem, print the Print Quality Test Pages. From the control panel, navigate to **Settings > Troubleshooting > Print Quality Test Pages**. For non-touch-screen printer models, press **OK** to navigate through the settings.

Action	Yes	No
<p><b>a</b> Check if the printer is using a genuine and supported Lexmark toner cartridge.</p> <p><b>Note:</b> If the cartridge is not supported, then install a supported one.</p> <p><b>b</b> Print the document.</p> <p>Do vertical light bands appear on prints?</p>	<p>Contact <a href="#">customer support</a>.</p>	<p>The problem is solved.</p>

### Vertical white lines



**Note:** Before solving the problem, print the Print Quality Test Pages. From the control panel, navigate to **Settings > Troubleshooting > Print Quality Test Pages**. For non-touch-screen printer models, press **OK** to navigate through the settings.

Action	Yes	No
<p><b>Step 1</b></p> <p><b>a</b> Check if the printer is using a genuine and supported Lexmark toner cartridge.</p> <p><b>Note:</b> If the cartridge is not supported, then install a supported one.</p> <p><b>b</b> Print the document.</p> <p>Do vertical white lines appear on prints?</p>	Go to step 2.	The problem is solved.
<p><b>Step 2</b></p> <p><b>a</b> Depending on your operating system, specify the paper type from the Printing Preferences or Print dialog.</p> <p><b>Notes:</b></p> <ul style="list-style-type: none"> <li>• Make sure that the setting matches the paper loaded.</li> <li>• You can also change the setting on the printer control panel.</li> </ul> <p><b>b</b> Print the document.</p> <p>Do vertical white lines appear on prints?</p>	Contact <a href="#">customer support</a> .	The problem is solved.

### Vertical dark bands

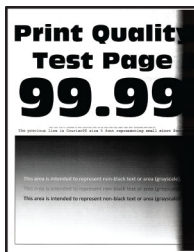

**Note:** Before solving the problem, print the Print Quality Test Pages. From the control panel, navigate to

**Settings > Troubleshooting > Print Quality Test Pages.** For non-touch-screen printer models, press  to navigate through the settings.

Action	Yes	No
<p><b>Step 1</b></p> <p><b>a</b> Check if the printer is using a genuine and supported Lexmark toner cartridge.</p> <p><b>Note:</b> If the toner cartridge is not supported, then install a supported one.</p> <p><b>b</b> Print the document.</p> <p>Do vertical dark bands appear on prints?</p>	<p>Go to step 2.</p>	<p>The problem is solved.</p>
<p><b>Step 2</b></p> <p><b>a</b> Remove the toner cartridge, and then remove the imaging unit.</p> <p><b>Warning—Potential Damage:</b> Do not expose the imaging unit to direct light for more than 10 minutes. Extended exposure to light may cause print quality problems.</p> <p><b>Warning—Potential Damage:</b> Do not touch the photoconductor drum under the imaging unit. Doing so may affect the quality of future print jobs.</p> <p><b>b</b> Insert the imaging unit, and then insert the cartridge.</p> <p><b>c</b> Print the document.</p> <p>Do vertical dark bands appear on prints?</p>	<p>Go to step 3.</p>	<p>The problem is solved.</p>

Action	Yes	No
<p><b>Step 3</b></p> <p><b>a</b> Remove the imaging unit.</p> <p><b>Warning—Potential Damage:</b> Do not expose the imaging unit to direct light for more than 10 minutes. Extended exposure to light may cause print quality problems.</p> <p><b>Warning—Potential Damage:</b> Do not touch the photoconductor drum under the imaging unit. Doing so may affect the quality of future print jobs.</p> <p><b>b</b> Remove any packing material that is stuck on the imaging unit.</p> <div data-bbox="402 625 781 1178" style="text-align: center;"> </div> <p><b>Note:</b> Make sure to remove any obstruction between the charge roller and photoconductor drum.</p> <p><b>c</b> Insert the imaging unit.</p> <p><b>d</b> Print the document.</p> <p>Do vertical dark bands appear on prints?</p>	<p>Go to step 4.</p>	<p>The problem is solved.</p>
<p><b>Step 4</b></p> <p><b>a</b> Check if a bright light enters the right side of the printer, and move the printer if necessary.</p> <p><b>b</b> Print the document.</p> <p>Do vertical dark bands appear on prints?</p>	<p>Contact <a href="#">customer support</a>.</p>	<p>The problem is solved.</p>

### Vertical dark lines or streaks



**Note:** Before solving the problem, print the Print Quality Test Pages. From the control panel, navigate to **Settings > Troubleshooting > Print Quality Test Pages**. For non-touch-screen printer models, press **OK** to navigate through the settings.

Action	Yes	No
<p><b>Step 1</b></p> <p><b>a</b> Check if the printer is using a genuine and supported Lexmark toner cartridge.</p> <p><b>Note:</b> If the toner cartridge is not supported, then install a supported one.</p> <p><b>b</b> Print the document.</p> <p>Do vertical dark lines or streaks appear on prints?</p>	Go to step 2.	The problem is solved.
<p><b>Step 2</b></p> <p><b>a</b> Remove, and then reinstall the imaging unit.</p> <p><b>Warning—Potential Damage:</b> Do not expose the imaging unit to direct light for more than 10 minutes. Extended exposure to light can cause print quality problems.</p> <p><b>Warning—Potential Damage:</b> Do not touch the photoconductor drum under the imaging unit. Doing so may affect the quality of future print jobs.</p> <p><b>b</b> Print the document.</p> <p>Do vertical dark lines or streaks appear on prints?</p>	Go to step 3.	The problem is solved.
<p><b>Step 3</b></p> <p><b>a</b> Replace the imaging unit.</p> <p><b>b</b> Print the document.</p> <p>Do vertical dark lines or streaks appear on prints?</p>	Contact <a href="#">customer support</a> .	The problem is solved.

### Vertical dark streaks with print missing

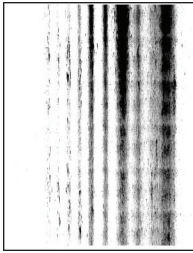

**Note:** Before solving the problem, print the Print Quality Test Pages. From the control panel, navigate to

**Settings > Troubleshooting > Print Quality Test Pages.** For non-touch-screen printer models, press **OK** to navigate through the settings.

Action	Yes	No
<p><b>Step 1</b></p> <p><b>a</b> Remove the imaging unit.</p> <p><b>Warning—Potential Damage:</b> Do not expose the imaging unit to direct light for more than 10 minutes. Extended exposure to light may cause print quality problems.</p> <p><b>Warning—Potential Damage:</b> Do not touch the photoconductor drum under the imaging unit. Doing so may affect the quality of future print jobs.</p> <p><b>b</b> Remove any packing material that is stuck on the imaging unit.</p> <div style="text-align: center;"> </div> <p><b>Note:</b> Make sure to remove any obstruction between the charge roller and photoconductor drum.</p> <p><b>c</b> Insert the imaging unit.</p> <p><b>d</b> Print the document.</p> <p>Do vertical dark streaks with missing images appear on prints?</p>	<p>Go to step 2.</p>	<p>The problem is solved.</p>

Action	Yes	No
<p><b>Step 2</b></p> <p><b>a</b> Check if the printer is using a genuine and supported Lexmark toner cartridge.</p> <p><b>Note:</b> If the toner cartridge is not supported, then install a supported one.</p> <p><b>b</b> Print the document.</p> <p>Do vertical dark streaks with missing images appear on prints?</p>	<p>Contact <a href="#">customer support</a>.</p>	<p>The problem is solved.</p>

### Repeating defects



**Note:** Before solving the problem, print the Print Quality Test Pages. From the control panel, navigate to **Settings > Troubleshooting > Print Quality Test Pages**. For non-touch-screen printer models, press **OK** to navigate through the settings.



Action	Yes	No
<p><b>Step 1</b></p> <p>Using the Print Quality Test Pages, check if the distance between the repeating defects is equal to any of the following:</p> <ul style="list-style-type: none"> <li>• 96 mm (3.78 in.)</li> <li>• 49 mm (1.93 in.)</li> <li>• 47.5 mm (1.87 in.)</li> <li>• 30.2 mm (1.18 in.)</li> </ul> <p>Does the distance between the repeating defects match any of the measurements?</p>	<p>Go to step 2.</p>	<p>Take note of the distance, and then contact <a href="#">customer support</a>.</p>
<p><b>Step 2</b></p> <p><b>a</b> Replace the imaging unit.</p> <p><b>b</b> Print the document.</p> <p>Do the repeating defects appear?</p>	<p>Contact <a href="#">customer support</a>.</p>	<p>The problem is solved.</p>

## Confidential and other held documents do not print

Action	Yes	No
<p><b>Step 1</b></p> <p><b>a</b> From the control panel, check if the documents appear in the Held Jobs list.</p> <p><b>Note:</b> If the documents are not listed, then print the documents using the Print and Hold options.</p> <p><b>b</b> Print the documents.</p> <p>Are the documents printed?</p>	The problem is solved.	Go to step 2.
<p><b>Step 2</b></p> <p>The print job may contain a formatting error or invalid data.</p> <ul style="list-style-type: none"> <li>• Delete the print job, and then send it again.</li> <li>• For PDF files, generate a new file, and then print the documents.</li> </ul> <p>Are the documents printed?</p>	The problem is solved.	Go to step 3.
<p><b>Step 3</b></p> <p>If you are printing from the Internet, then the printer may be reading the multiple job titles as duplicates.</p> <p><b>For Windows users</b></p> <p><b>a</b> Open the Printing Preferences dialog.</p> <p><b>b</b> From the Print and Hold section, select <b>Keep duplicate documents</b>.</p> <p><b>c</b> Enter a PIN.</p> <p><b>d</b> Resend the print job.</p> <p><b>For Macintosh users</b></p> <p><b>a</b> Save and name each job differently.</p> <p><b>b</b> Send the job individually.</p> <p>Are the documents printed?</p>	The problem is solved.	Go to step 4.
<p><b>Step 4</b></p> <p><b>a</b> Delete some held jobs to free up printer memory.</p> <p><b>b</b> Resend the print job.</p> <p>Are the documents printed?</p>	The problem is solved.	Go to step 5.
<p><b>Step 5</b></p> <p><b>a</b> Add printer memory.</p> <p><b>b</b> Resend the print job.</p> <p>Are the documents printed?</p>	The problem is solved.	Contact <a href="#">customer support</a> .



## Slow printing

Action	Yes	No
<p><b>Step 1</b></p> <p>Make sure that the printer cable is securely connected to the printer and to the computer, print server, option, or other network device.</p> <p>Is the printer printing slow?</p>	Go to step 2.	The problem is solved.
<p><b>Step 2</b></p> <p><b>a</b> Make sure that the printer is not in Eco-Mode or Quiet Mode.</p> <ul style="list-style-type: none"> <li>From the control panel, navigate to: <b>Settings &gt; Device &gt; Power Management &gt; Eco-Mode</b></li> <li>From the control panel, navigate to: <b>Settings &gt; Device &gt; Maintenance &gt; Configuration Menu &gt; Device Operations &gt; Quiet Mode</b></li> </ul> <p>For non-touch-screen printer models, press  to navigate through the settings.</p> <p><b>b</b> Print the document.</p> <p>Is the printer printing slow?</p>	Go to step 3.	The problem is solved.
<p><b>Step 3</b></p> <p><b>a</b> Depending on your operating system, specify the print resolution from the Printing Preferences or Print dialog.</p> <p><b>b</b> Set the resolution to 4800 CQ.</p> <p><b>c</b> Print the document.</p> <p>Is the printer printing slow?</p>	Go to step 4.	The problem is solved.
<p><b>Step 4</b></p> <p><b>a</b> From the control panel, navigate to: <b>Settings &gt; Print &gt; Quality &gt; Print Resolution</b></p> <p>For non-touch-screen printer models, press  to navigate through the settings.</p> <p><b>b</b> Set the resolution to 4800 CQ.</p> <p><b>c</b> Print the document.</p> <p>Is the printer printing slow?</p>	Go to step 5.	The problem is solved.

Action	Yes	No
<p><b>Step 5</b></p> <p><b>a</b> Depending on your operating system, specify the paper type from the Printing Preferences or Print dialog.</p> <p><b>Notes:</b></p> <ul style="list-style-type: none"> <li>• Make sure that the setting matches the paper loaded.</li> <li>• You can also change the setting on the printer control panel.</li> <li>• Heavier paper prints more slowly.</li> <li>• Paper narrower than letter, A4, and legal may print more slowly.</li> </ul> <p><b>b</b> Print the document.</p> <p>Is the printer printing slow?</p>	<p>Go to step 6.</p>	<p>The problem is solved.</p>
<p><b>Step 6</b></p> <p><b>a</b> Make sure that the printer settings for Media Texture and Media Weight match the paper being loaded.</p> <p>From the control panel, navigate to:</p> <p><b>Settings &gt; Paper &gt; Media Configuration &gt; Media Types</b></p> <p>For non-touch-screen printer models, press  to navigate through the settings.</p> <p><b>Note:</b> Rough paper textures and heavy paper weights may print more slowly.</p> <p><b>b</b> Print the document.</p> <p>Is the printer printing slow?</p>	<p>Go to step 7.</p>	<p>The problem is solved.</p>
<p><b>Step 7</b></p> <p>Remove held jobs.</p> <p>Is the printer printing slow?</p>	<p>Go to step 8.</p>	<p>The problem is solved.</p>
<p><b>Step 8</b></p> <p><b>a</b> Make sure that the printer is not overheating.</p> <p><b>Notes:</b></p> <ul style="list-style-type: none"> <li>• Allow the printer to cool down after a long print job.</li> <li>• Observe the recommended ambient temperature for the printer. For more information, see <a href="#">“Selecting a location for the printer” on page 10.</a></li> </ul> <p><b>b</b> Print the document.</p> <p>Is the printer printing slow?</p>	<p>Go to step 9.</p>	<p>The problem is solved.</p>

Action	Yes	No
<p><b>Step 9</b></p> <p><b>a</b> Add more printer memory.</p> <p><b>b</b> Print the document.</p> <p>Is the printer printing slow?</p>	<p>Contact <a href="#">customer support</a>.</p>	<p>The problem is solved.</p>

## Print jobs do not print

Action	Yes	No
<p><b>Step 1</b></p> <p><b>a</b> From the document you are trying to print, open the Print dialog, and then check if you have selected the correct printer.</p> <p><b>b</b> Print the document.</p> <p>Is the document printed?</p>	<p>The problem is solved.</p>	<p>Go to step 2.</p>
<p><b>Step 2</b></p> <p><b>a</b> Check if the printer is on.</p> <p><b>b</b> Resolve any error messages that appear on the display.</p> <p><b>c</b> Print the document.</p> <p>Is the document printed?</p>	<p>The problem is solved.</p>	<p>Go to step 3.</p>
<p><b>Step 3</b></p> <p><b>a</b> Check if the ports are working and if the cables are securely connected to the computer and the printer.</p> <p>For more information, see the setup documentation that came with the printer.</p> <p><b>b</b> Print the document.</p> <p>Is the document printed?</p>	<p>The problem is solved.</p>	<p>Go to step 4.</p>
<p><b>Step 4</b></p> <p><b>a</b> Turn off the printer, wait for about 10 seconds, and then turn on the printer.</p> <p><b>b</b> Print the document.</p> <p>Is the document printed?</p>	<p>The problem is solved.</p>	<p>Go to step 5.</p>
<p><b>Step 5</b></p> <p><b>a</b> Remove, and then reinstall the print driver.</p> <p><b>b</b> Print the document.</p> <p>Is the document printed?</p>	<p>The problem is solved.</p>	<p>Contact <a href="#">customer support</a>.</p>

## The printer is not responding

Action	Yes	No
<p><b>Step 1</b> Check if the power cord is connected to the electrical outlet.</p> <p> <b>CAUTION—POTENTIAL INJURY:</b> To avoid the risk of fire or electrical shock, connect the power cord to an appropriately rated and properly grounded electrical outlet that is near the product and easily accessible.</p> <p>Is the printer responding?</p>	The problem is solved.	Go to step 2.
<p><b>Step 2</b> Check if the electrical outlet is turned off by a switch or breaker.</p> <p>Is the electrical outlet turned off by a switch or breaker?</p>	Turn on the switch or reset the breaker.	Go to step 3.
<p><b>Step 3</b> Check if the printer is on.</p> <p>Is the printer on?</p>	Go to step 4.	Turn on the printer.
<p><b>Step 4</b> Check if the printer is in Sleep or Hibernate mode.</p> <p>Is the printer in Sleep or Hibernate mode?</p>	Press the power button to wake the printer.	Go to step 5.
<p><b>Step 5</b> Check if the cables connecting the printer and the computer are inserted to the correct ports.</p> <p>Are the cables inserted to the correct ports?</p>	Go to step 6.	Insert the cables to the correct ports.
<p><b>Step 6</b> Turn off the printer, install the hardware options, and then turn on the printer. For more information, see the documentation that came with the option.</p> <p>Is the printer responding?</p>	The problem is solved.	Go to step 7.
<p><b>Step 7</b> Install the correct print driver.</p> <p>Is the printer responding?</p>	The problem is solved.	Go to step 8.
<p><b>Step 8</b> Turn off the printer, wait for about 10 seconds, and then turn on the printer.</p> <p>Is the printer responding?</p>	The problem is solved.	Contact <a href="#">customer support</a> .

## Adjusting toner darkness

- 1 From the control panel, navigate to:  
**Settings > Print > Quality > Toner Darkness**

For non-touch-screen printer models, press  to navigate through the settings.

- 2 Adjust the setting.
- 3 Apply the changes.

## Job prints from the wrong tray or on the wrong paper

Action	Yes	No
<p><b>Step 1</b></p> <p><b>a</b> Check if you are printing on the correct paper.</p> <p><b>b</b> Print the document.</p> <p>Is the document printed on the correct paper?</p>	Go to step 2.	Load the correct paper size and paper type.
<p><b>Step 2</b></p> <p><b>a</b> Depending on your operating system, specify the paper size and paper type from the Printing Preferences or Print dialog.</p> <p><b>Note:</b> You can also change the settings on the printer control panel. Navigate to:  <b>Settings &gt; Paper &gt; Tray Configuration &gt; Paper Size/Type</b></p> <p>For non-touch-screen printer models, press  to navigate through the settings.</p> <p><b>b</b> Make sure that the settings match the paper loaded.</p> <p><b>c</b> Print the document.</p> <p>Is the document printed on the correct paper?</p>	The problem is solved.	Go to step 3.
<p><b>Step 3</b></p> <p><b>a</b> Check if the trays are linked.  For more information, see <a href="#">“Linking trays” on page 36</a>.</p> <p><b>b</b> Print the document.</p> <p>Is the document printed from the correct tray?</p>	The problem is solved.	Contact <a href="#">customer support</a> .

## Contacting customer support

Before contacting customer support, make sure to have the following information:

- Printer problem
- Error message
- Printer model type and serial number

Go to <http://support.lexmark.com> to receive e-mail or chat support, or browse through the library of manuals, support documentation, drivers, and other downloads.

Technical support via telephone is also available. In the U.S. or Canada, call 1-800-539-6275. For other countries or regions, go to <http://support.lexmark.com>.

# Upgrading and migrating

## Hardware

### Available internal options

- Flash memory
- Font cards
- Firmware cards
  - Forms and Bar Code
  - PRESCRIBE
  - IPDS
- Printer hard disk
- Internal solutions port
  - Parallel 1284-B Interface Card
  - RS-232C Serial Interface Card
  - Fiber Interface Card
  - N8350 802.11b/g/n Wireless Print Server Interface Card

### Accessing the controller board



**CAUTION—SHOCK HAZARD:** To avoid the risk of electrical shock, if you are accessing the controller board or installing optional hardware or memory devices sometime after setting up the printer, then turn the printer off, and unplug the power cord from the electrical outlet before continuing. If you have any other devices attached to the printer, then turn them off as well, and unplug any cables going into the printer.

- 1 Turn off the printer.
- 2 Unplug the power cord from the electrical outlet, and then from the printer.
- 3 Using a flat-head screwdriver, open the controller board access cover.

**Warning—Potential Damage:** Controller board electronic components are easily damaged by static electricity. Touch a metal surface on the printer before touching any controller board components or connectors.

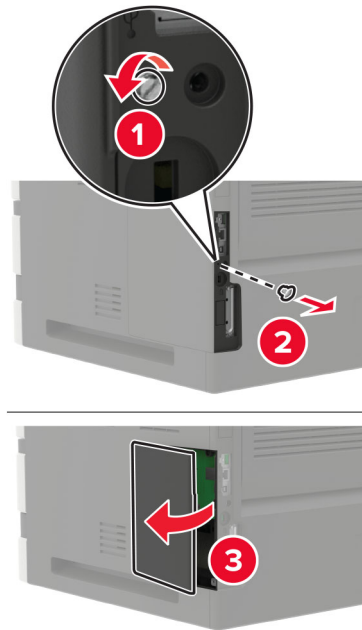

- 4 Install any supported internal options. For more information, see the documentation that came with the option.
- 5 Close the access cover.
- 6 Connect the power cord to the printer, and then to the electrical outlet.

**⚠ CAUTION—POTENTIAL INJURY:** To avoid the risk of fire or electrical shock, connect the power cord to an appropriately rated and properly grounded electrical outlet that is near the product and easily accessible.

- 7 Turn on the printer.

## Installing a memory card

**⚠ CAUTION—SHOCK HAZARD:** To avoid the risk of electrical shock, if you are accessing the controller board or installing optional hardware or memory devices sometime after setting up the printer, then turn the printer off, and unplug the power cord from the electrical outlet before continuing. If you have any other devices attached to the printer, then turn them off as well, and unplug any cables going into the printer.

- 1 Turn off the printer.
- 2 Unplug the power cord from the electrical outlet, and then from the printer.
- 3 Using a flat-head screwdriver, open the controller board access cover.

**Warning—Potential Damage:** Controller board electronic components are easily damaged by static electricity. Touch a metal surface on the printer before touching any controller board components or connectors.



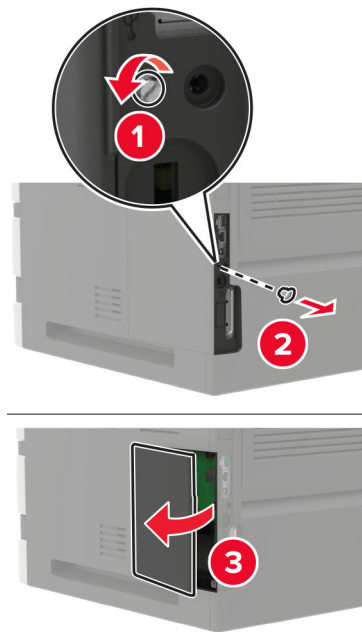

4 Unpack the memory card.

**Warning—Potential Damage:** Do not touch the connection points along the edge of the card.

5 Insert the memory card until it *clicks* into place.

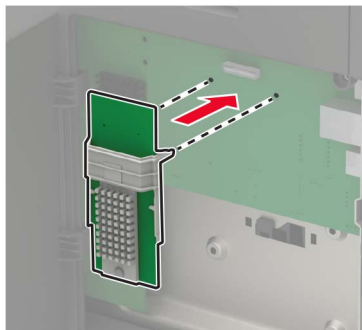

6 Close the access cover.

7 Connect the power cord to the printer, and then to the electrical outlet.

**CAUTION—POTENTIAL INJURY:** To avoid the risk of fire or electrical shock, connect the power cord to an appropriately rated and properly grounded electrical outlet that is near the product and easily accessible.

8 Turn on the printer.

## Installing an optional card

**⚠ CAUTION—SHOCK HAZARD:** To avoid the risk of electrical shock, if you are accessing the controller board or installing optional hardware or memory devices sometime after setting up the printer, then turn the printer off, and unplug the power cord from the electrical outlet before continuing. If you have any other devices attached to the printer, then turn them off as well, and unplug any cables going into the printer.

- 1 Turn off the printer.
- 2 Unplug the power cord from the electrical outlet, and then from the printer.
- 3 Using a flat-head screwdriver, open the controller board access cover.

**Warning—Potential Damage:** Controller board electronic components are easily damaged by static electricity. Touch a metal surface on the printer before touching any components or connectors.

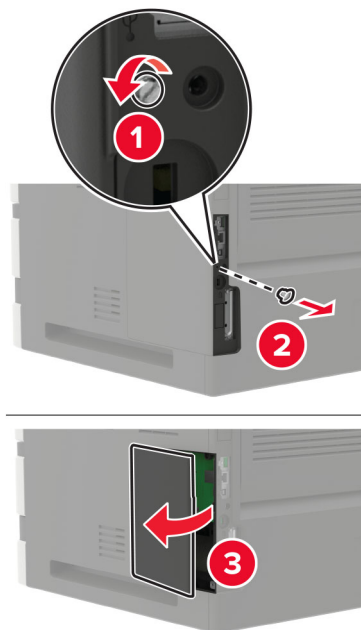

- 4 Unpack the optional card.

**Warning—Potential Damage:** Do not touch the connection points along the edge of the card.

- 5 Push the card firmly into place.

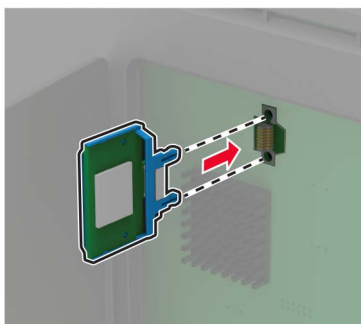

**Note:** The entire length of the connector on the card must touch and be flush against the controller board.

**Warning—Potential Damage:** Improper installation of the card may cause damage to the card and the controller board.

6 Close the access cover.

7 Connect the power cord to the printer, and then to the electrical outlet.

**CAUTION—POTENTIAL INJURY:** To avoid the risk of fire or electrical shock, connect the power cord to an appropriately rated and properly grounded electrical outlet that is near the product and easily accessible.

8 Turn on the printer.

## Installing a printer hard disk

**CAUTION—SHOCK HAZARD:** To avoid the risk of electrical shock, if you are accessing the controller board or installing optional hardware or memory devices sometime after setting up the printer, then turn the printer off, and unplug the power cord from the electrical outlet before continuing. If you have any other devices attached to the printer, then turn them off as well, and unplug any cables going into the printer.

1 Turn off the printer.

2 Unplug the power cord from the electrical outlet, and then from the printer.

3 Using a flat-head screwdriver, open the controller board access cover.

**Warning—Potential Damage:** Controller board electronic components are easily damaged by static electricity. Touch a metal surface on the printer before touching any controller board components or connectors.

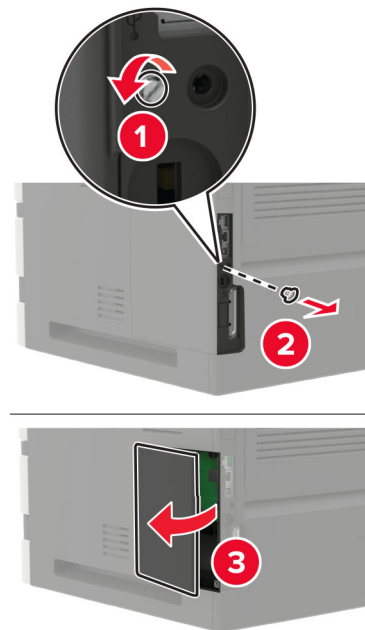

4 Unpack the printer hard disk.

- 5 Attach the hard disk, and then connect the hard disk interface cable to the controller board.

**Warning—Potential Damage:** Do not touch or press the center of the hard disk.

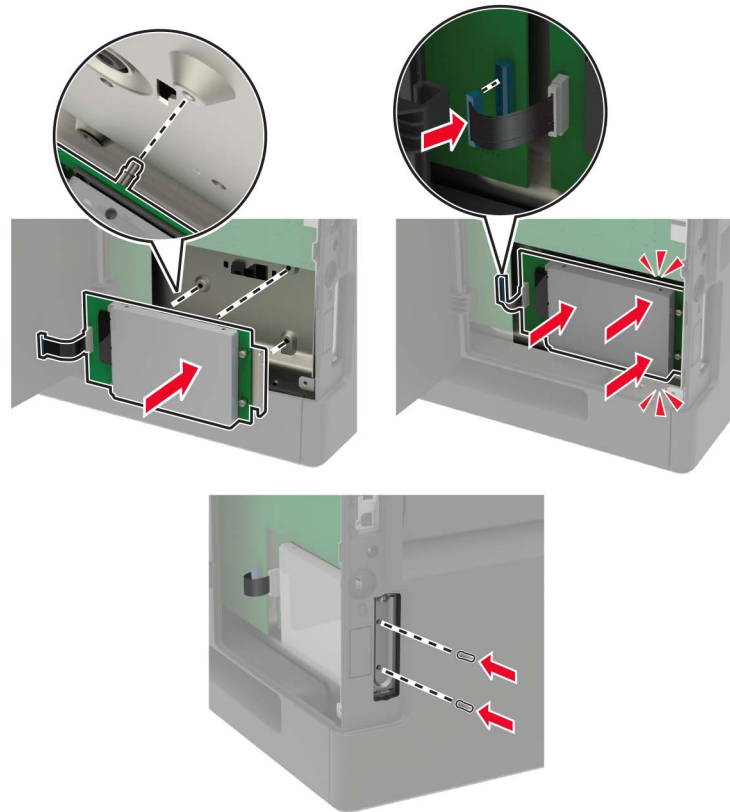

- 6 Close the access cover.
- 7 Connect the power cord to the printer, and then to the electrical outlet.

**CAUTION—POTENTIAL INJURY:** To avoid the risk of fire or electrical shock, connect the power cord to an appropriately rated and properly grounded electrical outlet that is near the product and easily accessible.

- 8 Turn on the printer.

## Installing an internal solutions port

**CAUTION—SHOCK HAZARD:** To avoid the risk of electrical shock, if you are accessing the controller board or installing optional hardware or memory devices sometime after setting up the printer, then turn the printer off, and unplug the power cord from the electrical outlet before continuing. If you have any other devices attached to the printer, then turn them off as well, and unplug any cables going into the printer.

- 1 Turn off the printer, and then unplug the power cord from the electrical outlet.
- 2 Using a flat-head screwdriver, open the controller board access cover.

**Warning—Potential Damage:** Controller board electronic components are easily damaged by static electricity. Touch a metal surface on the printer before touching any controller board components or connectors.

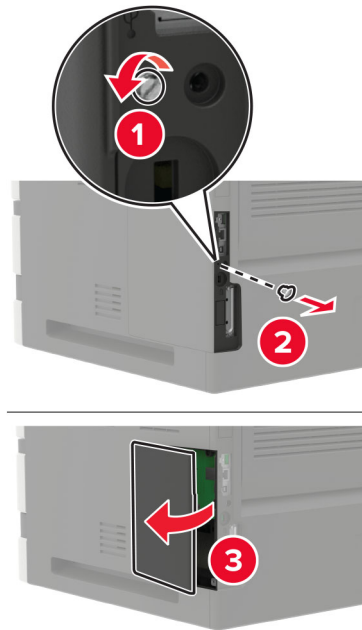

**3** Unpack the internal solutions port (ISP) kit.

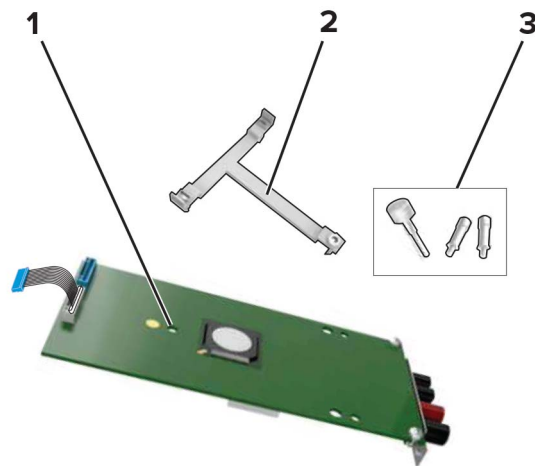

<b>1</b>	ISP
<b>2</b>	Mounting bracket
<b>3</b>	Thumbscrews

**4** If necessary, remove the printer hard disk.

**5** Insert the bracket into the board until it *clicks* into place.

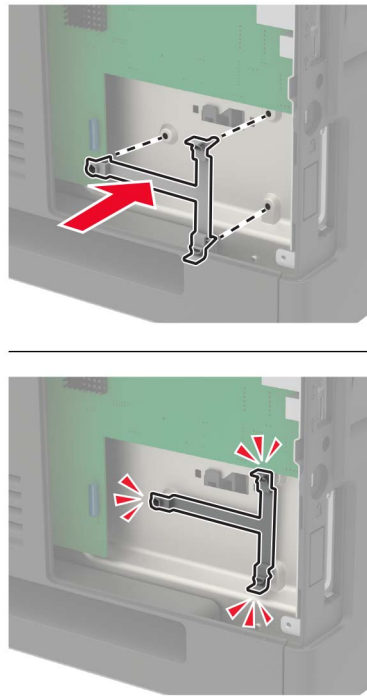

**6** Attach the ISP to the bracket.

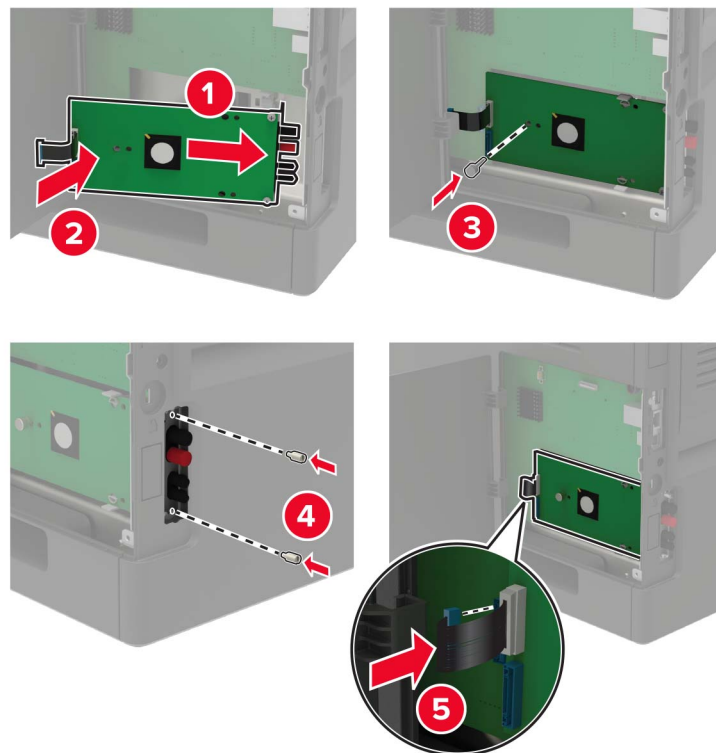

**7** If necessary, attach the hard disk to the ISP.

**a** Remove the hard disk bracket.

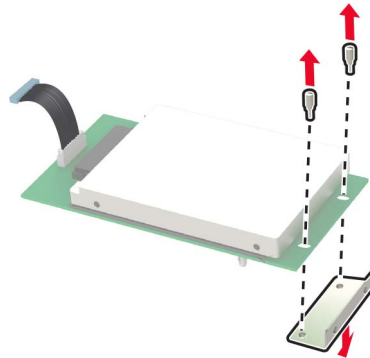

**b** Connect the hard disk to the ISP.

**Warning—Potential Damage:** Do not touch or press the center of the hard disk.

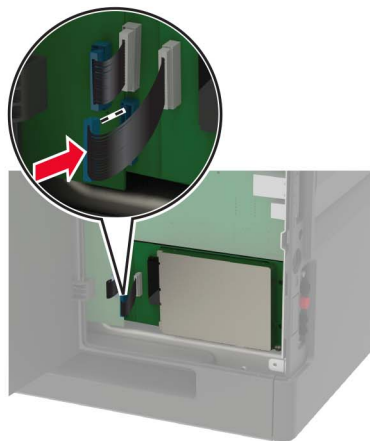
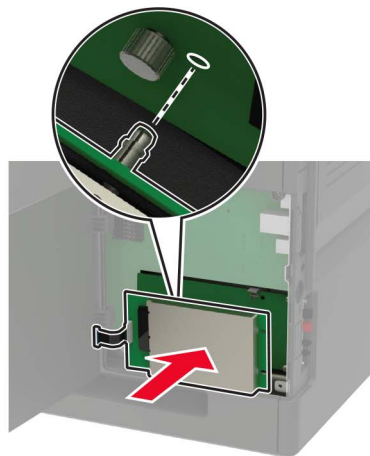

- 8 Close the access cover.
- 9 Connect the power cord to the electrical outlet, and then turn on the printer.

**⚠ CAUTION—POTENTIAL INJURY:** To avoid the risk of fire or electrical shock, connect the power cord to an appropriately rated and properly grounded electrical outlet that is near the product and easily accessible.

## Installing the 250- or 550-sheet tray

**⚠ CAUTION—SHOCK HAZARD:** To avoid the risk of electrical shock, if you are accessing the controller board or installing optional hardware or memory devices sometime after setting up the printer, then turn the printer off, and unplug the power cord from the electrical outlet before continuing. If you have any other devices attached to the printer, then turn them off as well, and unplug any cables going into the printer.

**⚠ CAUTION—TIPPING HAZARD:** Installing one or more options on your printer or MFP may require a caster base, furniture, or other feature to prevent instability causing possible injury. For more information on supported configurations, see [www.lexmark.com/multifunctionprinters](http://www.lexmark.com/multifunctionprinters).

- 1 Turn off the printer.
- 2 Unplug the power cord from the electrical outlet, and then from the printer.
- 3 Unpack the optional tray, and then remove all packing material.

**Note:** If optional trays are already installed, then unlock them from the printer before lifting the printer. Do not try to lift the printer and trays at the same time.

- 4 Align the printer with the optional tray, and then lower the printer until it *clicks* into place.

**⚠ CAUTION—POTENTIAL INJURY:** If the printer weight is greater than 18 kg (40 lb), then it requires two or more trained personnel to lift it safely.

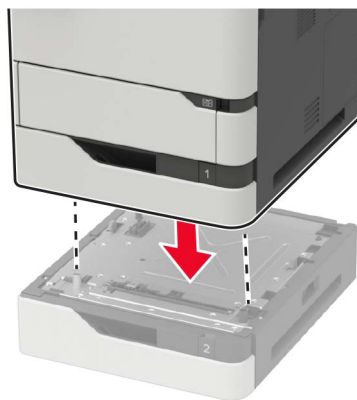

- 5 Connect the power cord to the printer, and then to the electrical outlet.

**⚠ CAUTION—POTENTIAL INJURY:** To avoid the risk of fire or electrical shock, connect the power cord to an appropriately rated and properly grounded electrical outlet that is near the product and easily accessible.

- 6 Turn on the printer.

Add the tray in the print driver to make it available for print jobs. For more information, see [“Adding available options in the print driver” on page 208](#).



## Installing the 2100-sheet tray

**⚠ CAUTION—SHOCK HAZARD:** To avoid the risk of electrical shock, if you are accessing the controller board or installing optional hardware or memory devices sometime after setting up the printer, then turn the printer off, and unplug the power cord from the electrical outlet before continuing. If you have any other devices attached to the printer, then turn them off as well, and unplug any cables going into the printer.

**⚠ CAUTION—TIPPING HAZARD:** Installing one or more options on your printer or MFP may require a caster base, furniture, or other feature to prevent instability causing possible injury. For more information on supported configurations, see [www.lexmark.com/multifunctionprinters](http://www.lexmark.com/multifunctionprinters).

- 1 Turn off the printer.
- 2 Unplug the power cord from the electrical outlet, and then from the printer.
- 3 Unpack the tray, and then remove all packing material.

**Note:** If optional trays are already installed, then unlock them from the printer before lifting the printer. Do not try to lift the printer and trays at the same time.

- 4 Install the tray on the caster base.

**Note:** Make sure that the caster base wheels are locked.

**⚠ CAUTION—POTENTIAL INJURY:** If the tray weight is greater than 18 kg (40 lb), then it requires two or more trained personnel to lift it safely.

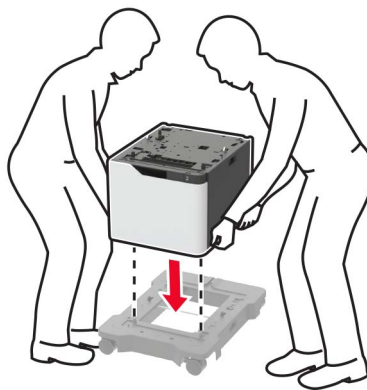

- 5 Align the printer with the tray, and then lower the printer until it *clicks* into place.

**⚠ CAUTION—POTENTIAL INJURY:** If the printer weight is greater than 18 kg (40 lb), then it requires two or more trained personnel to lift it safely.

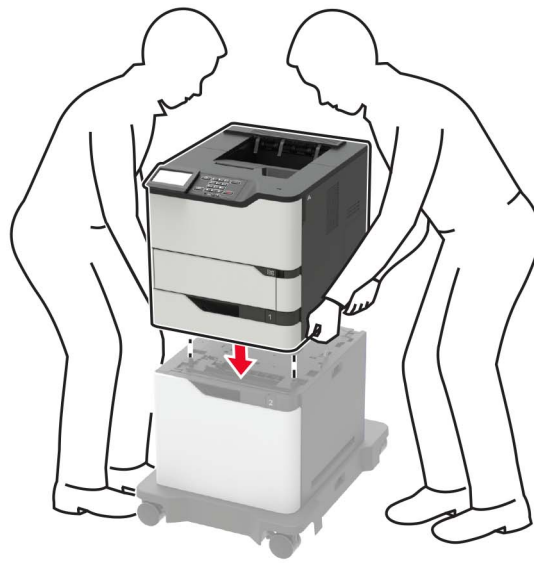

**6** Connect the power cord to the printer, and then to the electrical outlet.

**⚠ CAUTION—POTENTIAL INJURY:** To avoid the risk of fire or electrical shock, connect the power cord to an appropriately rated and properly grounded electrical outlet that is near the product and easily accessible.

**7** Turn on the printer.

Add the tray in the print driver to make it available for print jobs. For more information, see [“Adding available options in the print driver” on page 208](#).

## Installing the 4-bin mailbox

**CAUTION—TIPPING HAZARD:** Installing one or more options on your printer or MFP may require a caster base, furniture, or other feature to prevent instability causing possible injury. For more information on supported configurations, see [www.lexmark.com/multifunctionprinters](http://www.lexmark.com/multifunctionprinters).

- 1 Turn off the printer.
- 2 Unplug the power cord from the electrical outlet, and then from the printer.
- 3 Unpack the mailbox.

**Note:** You may need to install the guide bar before installing the mailbox. For more information, see the installation sheet that came with the guide bar.

- 4 Remove the printer top cover.

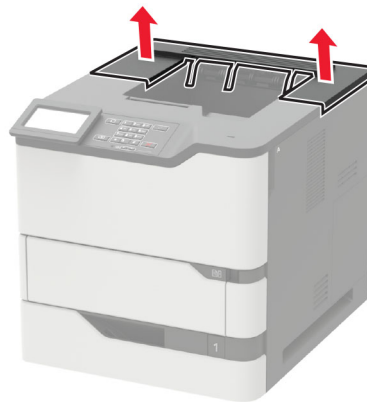

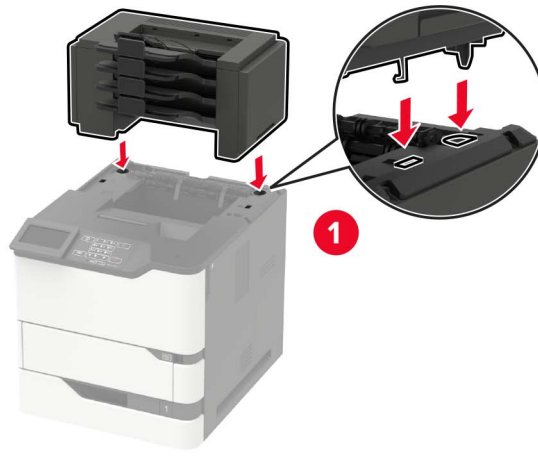
**5** Install the mailbox on the printer.

- A maximum of three mailboxes may be configured with the printer.
- If configured with the output expander, then the mailbox and output expander may be installed in any order.

**6** Connect the power cord to the printer, and then to the electrical outlet.

**⚠ CAUTION—POTENTIAL INJURY:** To avoid the risk of fire or electrical shock, connect the power cord to an appropriately rated and properly grounded electrical outlet that is near the product and easily accessible.

**7** Turn on the printer.

Add the mailbox in the print driver to make it available for print jobs. For more information, see [“Adding available options in the print driver” on page 208](#).

## Installing the output expander or high-capacity output expander

**CAUTION—TIPPING HAZARD:** Installing one or more options on your printer or MFP may require a caster base, furniture, or other feature to prevent instability causing possible injury. For more information on supported configurations, see [www.lexmark.com/multifunctionprinters](http://www.lexmark.com/multifunctionprinters).

- 1 Turn off the printer.
- 2 Unplug the power cord from the electrical outlet, and then from the printer.
- 3 Unpack the output expander or high-capacity output expander.

**Note:** You may need to install the guide bar before installing either of the options. For more information, see the installation sheet that came with the guide bar.

- 4 Remove the printer top cover.

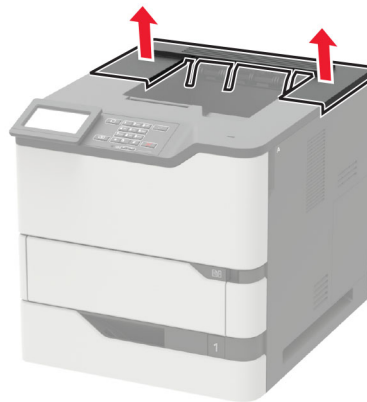

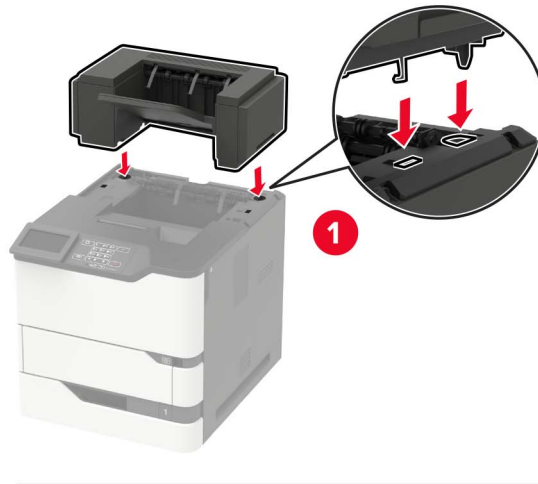
**5** Install the option on the printer.

In configuration with two or more hardware options:

- The output expander is the only option that can be placed on top of the high-capacity output expander.
- The high-capacity output expander must always be at the bottom.

**6** Connect the power cord to the printer, and then to the electrical outlet.

**⚠ CAUTION—POTENTIAL INJURY:** To avoid the risk of fire or electrical shock, connect the power cord to an appropriately rated and properly grounded electrical outlet that is near the product and easily accessible.

**7** Turn on the printer.

Add the option in the print driver to make it available for print jobs. For more information, see [“Adding available options in the print driver” on page 208](#).

## Installing the staple finisher

**CAUTION—TIPPING HAZARD:** Installing one or more options on your printer or MFP may require a caster base, furniture, or other feature to prevent instability causing possible injury. For more information on supported configurations, see [www.lexmark.com/multifunctionprinters](http://www.lexmark.com/multifunctionprinters).

- 1 Turn off the printer.
- 2 Unplug the power cord from the electrical outlet, and then from the printer.
- 3 Unpack the staple finisher.

**Note:** You may need to install the guide bar before installing the finisher. For more information, see the installation sheet that came with the guide bar.

- 4 Remove the printer top cover.

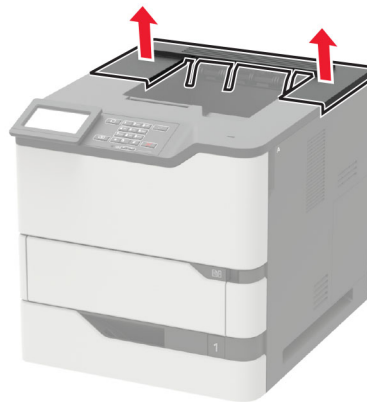

- 5 Install the staple finisher on the printer.



If configured with two or more optional hardware options, then the staple finisher must always be on top.

- 6 Connect the power cord to the printer, and then to the electrical outlet.

**⚠ CAUTION—POTENTIAL INJURY:** To avoid the risk of fire or electrical shock, connect the power cord to an appropriately rated and properly grounded electrical outlet that is near the product and easily accessible.

- 7 Turn on the printer.

Add the staple finisher in the print driver to make it available for print jobs. For more information, see [“Adding available options in the print driver” on page 208](#).



## Installing the staple, hole punch finisher

**CAUTION—TIPPING HAZARD:** Installing one or more options on your printer or MFP may require a caster base, furniture, or other feature to prevent instability causing possible injury. For more information on supported configurations, see [www.lexmark.com/multifunctionprinters](http://www.lexmark.com/multifunctionprinters).

- 1 Turn off the printer.
- 2 Unplug the power cord from the electrical outlet, and then from the printer.
- 3 Unpack the staple, hole punch finisher.

**Note:** You may need to install the guide bar before installing the finisher. For more information, see the installation sheet that came with the guide bar.

- 4 Remove the printer top cover.

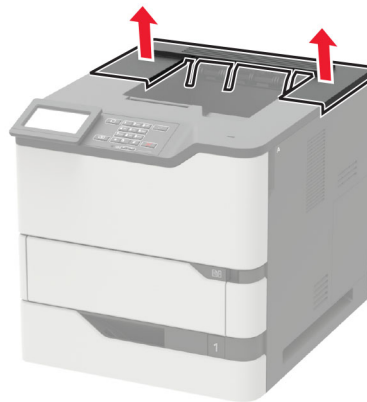

- 5 Install the finisher on the printer.

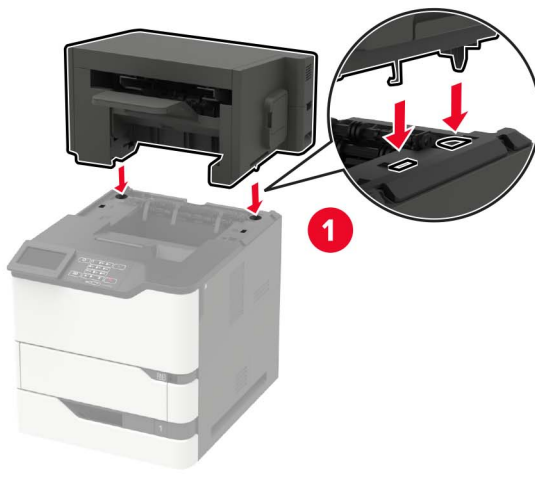

The finisher must not be combined with any other output options.

- 6 Connect the power cord to the printer, and then to the electrical outlet.

**⚠ CAUTION—POTENTIAL INJURY:** To avoid the risk of fire or electrical shock, connect the power cord to an appropriately rated and properly grounded electrical outlet that is near the product and easily accessible.

- 7 Turn on the printer.

Add the finisher in the print driver to make it available for print jobs. For more information, see [“Adding available options in the print driver” on page 208](#).

# Software

## Supported operating systems

Using the software CD, you can install the printer software on the following operating systems:

- Windows 10
- Windows 8.1
- Windows Server 2012 R2
- Windows Server 2012
- Windows 7 SP1
- Windows Server 2008 R2 SP1
- Windows Server 2008 SP2
- Windows Vista SP2
- Mac OS X version 10.7 or later
- Red Hat Enterprise Linux WS
- openSUSE Linux
- SUSE Linux Enterprise Server
- Debian GNU/Linux
- Ubuntu
- Fedora
- IBM AIX
- Oracle Solaris SPARC
- Oracle Solaris x86

### Notes:

- For Windows operating systems, the print drivers and utilities are supported in both 32- and 64-bit versions.
- For drivers and utilities that are compatible with Mac OS X version 10.6 or earlier and for specific supported Linux or UNIX operating system versions, go to <http://support.lexmark.com>.
- For more information on software compatibility with all other operating systems, contact customer support.

## Installing the printer software

- 1 Obtain a copy of the software installer package.
  - From the software CD that came with your printer.
  - Go to <http://support.lexmark.com>, and then select your printer and operating system.
- 2 Run the installer, and then follow the instructions on the computer screen.
- 3 For Macintosh users, add the printer.

**Note:** Obtain the printer IP address from the TCP/IP section in the Network/Ports menu.

## Adding available options in the print driver

### For Windows users

- 1 Open the printers folder.
- 2 Select the printer you want to update, and then do either of the following:
  - For Windows 7 or later, select **Printer properties**.
  - For earlier versions, select **Properties**.
- 3 Navigate to the Configuration tab, and then select **Update Now - Ask Printer**.
- 4 Apply the changes.

### For Macintosh users

- 1 From System Preferences in the Apple menu, navigate to your printer, and then select **Options & Supplies**.
- 2 Navigate to the list of hardware options, and then add any installed options.
- 3 Apply the changes.

## Firmware

### Exporting or importing a configuration file

You can export the configuration settings of your printer into a text file, and then import the file to apply the settings to other printers.

- 1 Open a web browser, and then type the printer IP address in the address field.

#### Notes:

- View the printer IP address on the printer home screen. The IP address appears as four sets of numbers separated by periods, such as 123.123.123.123.
- If you are using a proxy server, then temporarily disable it to load the web page correctly.

- 2 Export or import a configuration file for one or multiple applications.

#### For one application

- a From the Embedded Web Server, click **Apps** > the application that you want > **Configure**.
- b Click **Export** or **Import**.

#### For multiple applications

- a From the Embedded Web Server, click **Export Configuration** or **Import Configuration**.
- b Follow the instructions on the screen.

## Updating firmware

Some applications require a minimum device firmware level to operate correctly.

For more information on updating the device firmware, contact your Lexmark representative.

- 1** From the Embedded Web Server, click **Settings > Device > Update Firmware**.
- 2** Browse to locate the required flash file.
- 3** Apply the changes.

# Notices

## Product information

Product name:

Lexmark B2865dw; Lexmark M5255; Lexmark M5265; Lexmark M5270; Lexmark MS725dvn; Lexmark MS821n, MS821dn; Lexmark MS822de; Lexmark MS823n, MS823dn; Lexmark MS824de; Lexmark MS825dn; Lexmark MS826de

Machine type:

4064

Model(s):

210, 230, 235, 295, 410, 430, 435, 438, 495, 630, 635, 695, 830, and their equivalent models

## Edition notice

June 2018

**The following paragraph does not apply to any country where such provisions are inconsistent with local law:** LEXMARK INTERNATIONAL, INC., PROVIDES THIS PUBLICATION "AS IS" WITHOUT WARRANTY OF ANY KIND, EITHER EXPRESS OR IMPLIED, INCLUDING, BUT NOT LIMITED TO, THE IMPLIED WARRANTIES OF MERCHANTABILITY OR FITNESS FOR A PARTICULAR PURPOSE. Some states do not allow disclaimer of express or implied warranties in certain transactions; therefore, this statement may not apply to you.

This publication could include technical inaccuracies or typographical errors. Changes are periodically made to the information herein; these changes will be incorporated in later editions. Improvements or changes in the products or the programs described may be made at any time.

References in this publication to products, programs, or services do not imply that the manufacturer intends to make these available in all countries in which it operates. Any reference to a product, program, or service is not intended to state or imply that only that product, program, or service may be used. Any functionally equivalent product, program, or service that does not infringe any existing intellectual property right may be used instead. Evaluation and verification of operation in conjunction with other products, programs, or services, except those expressly designated by the manufacturer, are the user's responsibility.

For Lexmark technical support, visit <http://support.lexmark.com>.

For information on supplies and downloads, visit [www.lexmark.com](http://www.lexmark.com).

© 2018 Lexmark International, Inc.

All rights reserved.

## GOVERNMENT END USERS

The Software Program and any related documentation are "Commercial Items," as that term is defined in 48 C.F.R. 2.101, "Computer Software" and "Commercial Computer Software Documentation," as such terms are used in 48 C.F.R. 12.212 or 48 C.F.R. 227.7202, as applicable. Consistent with 48 C.F.R. 12.212 or 48 C.F.R. 227.7202-1 through 227.7207-4, as applicable, the Commercial Computer Software and Commercial Software

Documentation are licensed to the U.S. Government end users (a) only as Commercial Items and (b) with only those rights as are granted to all other end users pursuant to the terms and conditions herein.

## Trademarks

Lexmark, the Lexmark logo, and MarkNet are trademarks or registered trademarks of Lexmark International, Inc. in the United States and/or other countries.

Google Cloud Print and Google Chrome are trademarks of Google Inc.

Macintosh, the Mac logo, and Safari are trademarks of Apple Inc.

Microsoft, Windows, and Internet Explorer are either registered trademarks or trademarks of the Microsoft group of companies in the United States and other countries.

Mopria®, the Mopria® logo, and the Mopria® Alliance logo are registered trademarks and service marks of Mopria Alliance, Inc. in the United States and other countries. Unauthorized use is strictly prohibited.

PCL® is a registered trademark of the Hewlett-Packard Company. PCL is Hewlett-Packard Company’s designation of a set of printer commands (language) and functions included in its printer products. This printer is intended to be compatible with the PCL language. This means the printer recognizes PCL commands used in various application programs, and that the printer emulates the functions corresponding to the commands.

PostScript is a registered trademark of Adobe Systems Incorporated in the United States and/or other countries.

All other trademarks are the property of their respective owners.

AirPrint and the AirPrint logo are trademarks of Apple, Inc.

## Licensing notices

All licensing notices associated with this product can be viewed from the CD:\NOTICES directory of the installation software CD.

## Noise emission levels

The following measurements were made in accordance with ISO 7779 and reported in conformance with ISO 9296.

**Note:** Some modes may not apply to your product.

1-meter average sound pressure, dBA	
Printing	56 (MS725dvn); 57 (B2865dw, M5255, M5265, MS821n, MS821dn, MS822de, MS823n, MS823dn, MS824de); 58 (M5270, MS825dn, MS826de)
Ready	28 (MS725dvn); 14 (B2865dw, M5255, M5265, M5270, MS821n, MS821dn, MS822de, MS823n, MS823dn, MS824de, MS825dn, MS826de)

Values are subject to change. See [www.lexmark.com](http://www.lexmark.com) for current values.

## Waste from Electrical and Electronic Equipment (WEEE) directive



The WEEE logo signifies specific recycling programs and procedures for electronic products in countries of the European Union. We encourage the recycling of our products.

If you have further questions about recycling options, visit the Lexmark Web site at [www.lexmark.com](http://www.lexmark.com) for your local sales office phone number.

## India E-Waste notice

This product complies with the India E-Waste (Management and Handling) Rules, 2011, which prohibit use of lead, mercury, hexavalent chromium, polybrominated biphenyls, or polybrominated diphenyl ethers in concentrations exceeding 0.1% by weight and 0.01% by weight for cadmium, except for the exemption set in Schedule II of the Rules.

## Product disposal

Do not dispose of the printer or supplies in the same manner as normal household waste. Consult your local authorities for disposal and recycling options.

## Static sensitivity notice

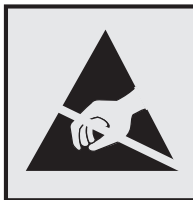

This symbol identifies static-sensitive parts. Do not touch the areas near these symbols without first touching a metal surface in an area away from the symbol.

To prevent damage from electrostatic discharge when performing maintenance tasks such as clearing paper jams or replacing supplies, touch any exposed metal frame of the printer before accessing or touching interior areas of the printer even if the symbol is not present.



## ENERGY STAR

Any Lexmark product bearing the ENERGY STAR emblem on the product or on a start-up screen is certified to comply with Environmental Protection Agency (EPA) ENERGY STAR requirements as configured when shipped by Lexmark.



### Temperature information

Operating temperature and relative humidity	15.3 to 32.2°C (60 to 90°F) and 8 to 80% RH
Printer / cartridge / imaging unit long-term storage <sup>1</sup>	1.1 to 35°C (34 to 95°F) and 8 to 80% RH Maximum wet-bulb temperature <sup>2</sup> : 22.8°C (73°F) Non-condensing environment
Printer / cartridge / imaging unit short-term shipping	-40 to 43.3°C (-40 to 110°F)
<sup>1</sup> Supplies shelf life is approximately 2 years. This is based on storage in a standard office environment at 22°C (72°F) and 45% humidity. <sup>2</sup> Wet-bulb temperature is determined by the air temperature and the relative humidity.	

### Laser notice

The printer is certified in the U.S. to conform to the requirements of DHHS 21 CFR, Chapter I, Subchapter J for Class I (1) laser products, and elsewhere is certified as a Class I laser product conforming to the requirements of IEC 60825-1: 2014.

Class I laser products are not considered to be hazardous. The laser system and printer are designed so there is never any human access to laser radiation above a Class I level during normal operation, user maintenance, or prescribed service conditions. The printer has a non-serviceable printhead assembly that contains a laser with the following specifications:

Class: IIIb (3b) AlGaAs

Nominal output power (milliwatts): 25

Wavelength (nanometers): 755–800

### Power consumption

#### Product power consumption

The following table documents the power consumption characteristics of the product.

**Note:** Some modes may not apply to your product.

Mode	Description	Power consumption (Watts)
Printing	The product is generating hard-copy output from electronic inputs.	800 (MS725dvn); 670 (M5255, MS821n, MS821dn); 700 (MS822de); 770 (B2865dw, M5265, MS823n, MS823dn, MS824de); 830 (M5270, MS825dn, MS826de)
Copy	The product is generating hard-copy output from hard-copy original documents.	N/A
Scan	The product is scanning hard-copy documents.	N/A
Ready	The product is waiting for a print job.	High power usage: 95 (MS725dvn); 39 (M5255, MS821n, MS821dn, MS822de); 34 (B2865dw, M5265, MS823n, MS823dn, MS824de); 38.5 (M5270, MS825dn, MS826de) Low power usage: 75 (MS725dvn); 21.5 (M5255, MS821n, MS821dn, MS822de); 20 (B2865dw, M5265, MS823n, MS823dn, MS824de); 21 (M5270, MS825dn, MS826de)
Sleep Mode	The product is in a high-level energy-saving mode.	1.3 (MS725dvn); 1.4 (M5255, M5270, MS821n, MS821dn, MS822de, MS825dn, MS826de); 1.6 (B2865dw, M5265, MS823n, MS823dn, MS824de)
Hibernate	The product is in a low-level energy-saving mode.	0.2
Off	The product is plugged into an electrical outlet, but the power switch is turned off.	0.2

The power consumption levels listed in the previous table represent time-averaged measurements. Instantaneous power draws may be substantially higher than the average.

Values are subject to change. See [www.lexmark.com](http://www.lexmark.com) for current values.

### Sleep Mode

This product is designed with an energy-saving mode called *Sleep Mode*. The Sleep Mode saves energy by lowering power consumption during extended periods of inactivity. The Sleep Mode is automatically engaged after this product is not used for a specified period of time, called the *Sleep Mode Timeout*.

Factory default Sleep Mode Timeout for this product (in minutes):	15
---	----

By using the configuration menus, the Sleep Mode Timeout can be modified between 1 minute and 120 minutes. Setting the Sleep Mode Timeout to a low value reduces energy consumption, but may increase the response time of the product. Setting the Sleep Mode Timeout to a high value maintains a fast response, but uses more energy.

### Hibernate Mode

This product is designed with an ultra-low power operating mode called *Hibernate mode*. When operating in Hibernate Mode, all other systems and devices are powered down safely.

The Hibernate mode can be entered in any of the following methods:

- Using the Hibernate Timeout
- Using the Schedule Power modes

Factory default Hibernate Timeout for this product in all countries or regions	3 days
--	--------

The amount of time the printer waits after a job is printed before it enters Hibernate mode can be modified between one hour and one month.

### Off mode

If this product has an off mode which still consumes a small amount of power, then to completely stop product power consumption, disconnect the power supply cord from the electrical outlet.

### Total energy usage

It is sometimes helpful to estimate the total product energy usage. Since power consumption claims are provided in power units of Watts, the power consumption should be multiplied by the time the product spends in each mode in order to calculate energy usage. The total product energy usage is the sum of each mode's energy usage.

## Regulatory notices for wireless products

This section contains regulatory information that applies only to wireless models.

If in doubt as to whether your model is a wireless model, go to <http://support.lexmark.com>.

## Modular component notice

Wireless-equipped models contain the following modular component(s):

Lexmark Regulatory Type/Model: LEX-M07-001; FCC ID: IYLLEXM07001; Industry Canada IC: 2376A-M07001

## Exposure to radio frequency radiation

The radiated output power of this device is far below the radio frequency exposure limits of the FCC and other regulatory agencies. A minimum separation of 20 cm (8 inches) must be maintained between the antenna and any persons for this device to satisfy the RF exposure requirements of the FCC and other regulatory agencies.

## Industry Canada (Canada)

Under Industry Canada regulations, this radio transmitter may only operate using an antenna of a type and maximum (or lesser) gain approved for the transmitter by Industry Canada. To reduce potential radio interference to other users, the antenna type and its gain should be so chosen that the equivalent isotropically radiated power (EIRP) is not more than that necessary for successful communication.

This device complies with Industry Canada license-exempt RSS standards. Operation is subject to the following two conditions: (1) this device may not cause interference, and (2) this device must accept any interference, including interference that may cause undesired operation of the device.

To prevent radio interference to the licensed service and to reduce the potential for harmful interference to co-channel mobile satellite systems, this device is intended to be operated indoors and away from windows to provide maximum shielding.

High-power radars are allocated as primary users (i.e., priority users) of the bands 5250–5350MHz and 5650–5850MHz. These radars could cause interference and/or damage to LE-LAN devices.

### **Industrie Canada (Canada)**

Selon la réglementation d'Industrie Canada, l'émetteur radio ne fonctionne qu'avec une antenne dont le type et le gain maximal (ou inférieur) ont été approuvés par Industrie Canada. Pour réduire les interférences radio potentielles auprès d'autres utilisateurs, le type d'antenne et son gain doivent être choisis de telle sorte que la puissance isotrope rayonnée équivalente (PIRE) ne soit pas supérieure à ce qui est nécessaire pour assurer la réussite de la communication.

Cet appareil est conforme aux normes RSS exemptes de licence d'Industrie Canada. Son fonctionnement est soumis aux deux conditions suivantes : (1) cet appareil ne doit pas causer d'interférences et (2) il doit accepter toutes les interférences, y compris les celles qui peuvent entraîner un fonctionnement indésirable.

Afin de prévenir les interférences radio des services sous licence et pour réduire le risque d'interférences nuisibles aux systèmes de satellites mobiles utilisant les mêmes canaux, cet appareil est destiné à être utilisé à l'intérieur et loin des fenêtres afin de fournir une protection maximale.

Les radars à haute puissance sont définis comme les utilisateurs principaux (p. ex., utilisateurs prioritaires) dans les bandes de 5250-5350 MHz et 5650-5850 MHz. Ces radars peuvent causer des interférences ou des dommages aux appareils RELOC-EL.

### **European Community (EC) directives conformity**

This product is in conformity with the protection requirements of EC Council directive 2014/53/EU on the approximation and harmonization of the laws of the Member States relating to radio equipment.

The manufacturer of this product is: Lexmark International, Inc., 740 West New Circle Road, Lexington, KY, 40550 USA. The authorized representative is: Lexmark International Technology Hungária Kft., 8 Lechner Ödön fasor, Millennium Tower III, 1095 Budapest HUNGARY. A declaration of conformity to the requirements of the Directives is available upon request from the Authorized Representative or may be obtained at [www.lexmark.com/en\\_us/about/regulatory-compliance/european-union-declaration-of-conformity.html](http://www.lexmark.com/en_us/about/regulatory-compliance/european-union-declaration-of-conformity.html).

Compliance is indicated by the CE marking:



### **Restrictions**

This radio equipment is restricted to indoor use only. Outdoor use is prohibited. This restriction applies to all the countries listed in the table below:



AT	BE	BG	CH	CY	CZ	DE	DK	EE
EL	ES	FI	FR	HR	HU	IE	IS	IT
LI	LT	LU	LV	MT	NL	NO	PL	PT
RO	SE	SI	SK	TR	UK			

**EU statement of radio transmitter operational frequency bands and maximum RF power**

This radio product transmits in either the 2.4GHz (2.412–2.472 GHz in the EU) or 5GHz (5.15–5.35, 5.47–5.725 in the EU) bands. The maximum transmitter EIRP power output, including antenna gain, is ≤ 20dBm for both bands.

**Federal Communications Commission (FCC) compliance information statement**

This product has been tested and found to comply with the limits for a Class A digital device, pursuant to Part 15 of the FCC Rules. Operation is subject to the following two conditions: (1) this device may not cause harmful interference, and (2) this device must accept any interference received, including interference that may cause undesired operation.

The FCC Class A limits are designed to provide reasonable protection against harmful interference when the equipment is operated in a commercial environment. This equipment generates, uses, and can radiate radio frequency energy and, if not installed and used in accordance with the instruction manual, may cause harmful interference to radio communications. Operation of this equipment in a residential area is likely to cause harmful interference, in which case the user will be required to correct the interference at his own expense.

The manufacturer is not responsible for any radio or television interference caused by using other than recommended cables or by unauthorized changes or modifications to this equipment. Unauthorized changes or modifications could void the user's authority to operate this equipment.

**Note:** To assure compliance with FCC regulations on electromagnetic interference for a Class A computing device, use a properly shielded and grounded cable such as Lexmark part number 1021231 for parallel attach or 1021294 for USB attach. Use of a substitute cable not properly shielded and grounded may result in a violation of FCC regulations.

Any questions regarding this compliance information statement should be directed to:

Director of Lexmark Technology & Services  
 Lexmark International, Inc.  
 740 West New Circle Road  
 Lexington, KY 40550  
 Telephone: (859) 232–3000  
 E-mail: regulatory@lexmark.com

## Industry Canada compliance statement

This Class A digital apparatus meets all requirements of the Canadian Interference-Causing Equipment Standard ICES-003.

## Avis de conformité aux normes de l'industrie du Canada

Cet appareil numérique de classe A est conforme aux exigences de la norme canadienne relative aux équipements pouvant causer des interférences NMB-003.

## Notice to users of Class A products in Brazil

Este produto não é apropriado para uso em ambientes domésticos, pois poderá causar interferências eletromagnéticas que obrigam o usuário a tomar medidas necessárias para minimizar estas interferências.

## European Community (EC) directives conformity

This product is in conformity with the protection requirements of EC Council directives 2014/30/EU, 2014/35/EU, and 2011/65/EU on the approximation and harmonization of the laws of the Member States relating to electromagnetic compatibility, safety of electrical equipment designed for use within certain voltage limits, and on the restrictions of use of certain hazardous substances in electrical and electronic equipment.

The manufacturer of this product is: Lexmark International, Inc., 740 West New Circle Road, Lexington, KY, 40550 USA. The authorized representative is: Lexmark International Technology Hungária Kft., 8 Lechner Ödön fasor, Millennium Tower III, 1095 Budapest HUNGARY. A declaration of conformity to the requirements of the Directives is available upon request from the Authorized Representative or may be obtained at [www.lexmark.com/en\\_us/about/regulatory-compliance/european-union-declaration-of-conformity.html](http://www.lexmark.com/en_us/about/regulatory-compliance/european-union-declaration-of-conformity.html).

This product satisfies the Class A limits of EN 55022 and EN55032 and safety requirements of EN 60950-1 or EN 62368-1.

## Radio interference notice

### Warning

This is a product that complies with the emission requirements of EN55022 and EN55032 Class A limits and immunity requirements of EN55024. This product is not intended to be used in residential/domestic environments.

This is a Class A product. In a domestic environment, this product may cause radio interference, in which case the user may be required to take adequate measures.

## **STATEMENT OF LIMITED WARRANTY FOR LEXMARK LASER PRINTERS, LEXMARK LED PRINTERS, AND LEXMARK MULTIFUNCTION LASER PRINTERS**

### **Lexmark International, Inc., Lexington, KY**

This limited warranty applies to the United States and Canada. For customers outside the U.S., refer to the country-specific warranty information that came with your product.

This limited warranty applies to this product only if it was originally purchased for your use, and not for resale, from Lexmark or a Lexmark Remarketer, referred to in this statement as “Remarketer.”

### **Limited warranty**

Lexmark warrants that this product:

- Is manufactured from new parts, or new and serviceable used parts, which perform like new parts
- Is, during normal use, free from defects in material and workmanship

If this product does not function as warranted during the warranty period, contact a Remarketer or Lexmark for repair or replacement (at Lexmark's option).

If this product is a feature or option, this statement applies only when that feature or option is used with the product for which it was intended. To obtain warranty service, you may be required to present the feature or option with the product.

If you transfer this product to another user, warranty service under the terms of this statement is available to that user for the remainder of the warranty period. You should transfer proof of original purchase and this statement to that user.

### **Limited warranty service**

The warranty period starts on the date of original purchase as shown on the purchase receipt and ends 12 months later provided that the warranty period for any supplies and for any maintenance items included with the printer shall end earlier if it, or its original contents, are substantially used up, depleted, or consumed. Fuser Units, Transfer/Transport Units, Paper Feed items, if any, and any other items for which a Maintenance Kit is available are substantially consumed when the printer displays a “Life Warning” or “Scheduled Maintenance” message for such item.

To obtain warranty service you may be required to present proof of original purchase. You may be required to deliver your product to the Remarketer or Lexmark, or ship it prepaid and suitably packaged to a Lexmark designated location. You are responsible for loss of, or damage to, a product in transit to the Remarketer or the Lexmark designated location.

When warranty service involves the exchange of a product or part, the item replaced becomes the property of the Remarketer or Lexmark. The replacement may be a new or repaired item.

The replacement item assumes the remaining warranty period of the original product.

Replacement is not available to you if the product you present for exchange is defaced, altered, in need of a repair not included in warranty service, damaged beyond repair, or if the product is not free of all legal obligations, restrictions, liens, and encumbrances.

As part of your warranty service and/or replacement, Lexmark may update the firmware in your printer to the latest version. Firmware updates may modify printer settings and cause counterfeit and/or unauthorized products, supplies, parts, materials (such as toners and inks), software, or interfaces to stop working. Authorized use of genuine Lexmark products will not be impacted.

Before you present this product for warranty service, remove all print cartridges, programs, data, and removable storage media (unless directed otherwise by Lexmark).

For further explanation of your warranty alternatives and the nearest Lexmark authorized servicer in your area contact Lexmark on the World Wide Web.

Remote technical support is provided for this product throughout its warranty period. For products no longer covered by a Lexmark warranty, technical support may not be available or only be available for a fee.

### **Extent of limited warranty**

Lexmark does not warrant uninterrupted or error-free operation of any product or the durability or longevity of prints produced by any product.

Warranty service does not include repair of failures caused by:

- Modification or unauthorized attachments
- Accidents, misuse, abuse or use inconsistent with Lexmark user's guides, manuals, instructions or guidance
- Unsuitable physical or operating environment
- Maintenance by anyone other than Lexmark or a Lexmark authorized servicer
- Operation of a product beyond the limit of its duty cycle
- Use of printing media outside of Lexmark specifications
- Refurbishment, repair, refilling or remanufacture by a third party of products, supplies or parts
- Products, supplies, parts, materials (such as toners and inks), software, or interfaces not furnished by Lexmark

**TO THE EXTENT PERMITTED BY APPLICABLE LAW, NEITHER LEXMARK NOR ITS THIRD PARTY SUPPLIERS OR REMARKETERS MAKE ANY OTHER WARRANTY OR CONDITION OF ANY KIND, WHETHER EXPRESS OR IMPLIED, WITH RESPECT TO THIS PRODUCT, AND SPECIFICALLY DISCLAIM THE IMPLIED WARRANTIES OR CONDITIONS OF MERCHANTABILITY, FITNESS FOR A PARTICULAR PURPOSE, AND SATISFACTORY QUALITY. ANY WARRANTIES THAT MAY NOT BE DISCLAIMED UNDER APPLICABLE LAW ARE LIMITED IN DURATION TO THE WARRANTY PERIOD. NO WARRANTIES, EXPRESS OR IMPLIED, WILL APPLY AFTER THIS PERIOD. ALL INFORMATION, SPECIFICATIONS, PRICES, AND SERVICES ARE SUBJECT TO CHANGE AT ANY TIME WITHOUT NOTICE.**

### **Limitation of liability**

Your sole remedy under this limited warranty is set forth in this document. For any claim concerning performance or nonperformance of Lexmark or a Remarketer for this product under this limited warranty, you may recover actual damages up to the limit set forth in the following paragraph.

Lexmark's liability for actual damages from any cause whatsoever will be limited to the amount you paid for the product that caused the damages. This limitation of liability will not apply to claims by you for bodily injury or damage to real property or tangible personal property for which Lexmark is legally liable. **IN NO EVENT WILL LEXMARK BE LIABLE FOR ANY LOST PROFITS, LOST SAVINGS, INCIDENTAL DAMAGE, OR OTHER ECONOMIC OR CONSEQUENTIAL DAMAGES.** This is true even if you advise Lexmark or a Remarketer of the possibility of such damages. Lexmark is not liable for any claim by you based on a third party claim.



This limitation of remedies also applies to claims against any Suppliers and Remarketers of Lexmark. Lexmark's and its Suppliers' and Remarketers' limitations of remedies are not cumulative. Such Suppliers and Remarketers are intended beneficiaries of this limitation.

**Additional rights**

Some states do not allow limitations on how long an implied warranty lasts, or do not allow the exclusion or limitation of incidental or consequential damages, so the limitations or exclusions contained above may not apply to you.

This limited warranty gives you specific legal rights. You may also have other rights that vary from state to state.

# Index

## Numerics

- 2100-sheet tray
  - installing 197
  - loading 30
- 4-bin mailbox
  - installing 199

## A

- accessing the controller board 187
- activating Voice Guidance 25
- adding contacts 22
- adding groups 23
- adding hardware options
  - print driver 208
- adding internal options
  - print driver 208
- adjusting speech rate
  - Voice Guidance 26
- adjusting the brightness
  - display 124
- adjusting the default headphones volume 98
- adjusting the default speaker volume 98
- adjusting toner darkness 185
- AirPrint
  - using 46
- attaching cables 13
- avoiding paper jams 126

## B

- blank pages 154
- bookmarks
  - creating 21
  - creating folders for 22

## C

- cannot open Embedded Web Server 146
- changing the printer port settings after installing ISP 100
- changing the wallpaper 19
- checking the printer connectivity 148
- checking the status of parts and supplies 101

- cleaning
  - exterior of the printer 100
  - interior of the printer 100
- cleaning the printer 100
- clearing jam
  - in door A 130
  - in door H 138
  - in door N 137
  - in high-capacity output expander 136
  - in mailbox bin 137
  - in output expander 136
  - in the duplex unit 133
  - in the fuser 133
  - in the multipurpose feeder 135
  - in the staple finisher 140
  - in the staple finisher bin 138
  - in the staple, hole punch finisher 139
  - in the staple, hole punch finisher bin 139
  - in trays 130
- clearing staple jam
  - in the staple, hole punch finisher 143
- Cloud Connector profile
  - creating 20
  - printing from 49
- collated printing does not work 151
- confidential print jobs 48
  - printing from a Macintosh computer 48
  - printing from Windows 48
- configuring Eco-Mode setting 20
- configuring Eco-Settings 20
- configuring supply notifications 105
- configuring Universal paper 27
- connecting the printer
  - to a wireless network 98
- connecting to a wireless network
  - using PIN method 99
  - using Push Button method 99
- conserving supplies 124
- contacting customer support 185
- contacts
  - adding 22

- deleting 23
- editing 23
- controller board
  - accessing 187
- creating a Cloud Connector profile 20
- creating bookmarks 21
- creating folders
  - for bookmarks 22
- crooked print 167
- Customer Support
  - using 21
- customer support
  - contacting 185
- customizing the display 19

## D

- deactivating the Wi-Fi network 99
- default headphones volume
  - adjusting 98
- default speaker volume
  - adjusting 98
- Defective flash detected 149
- deleting contacts 23
- deleting groups 23
- Device Quotas
  - setting up 20
- directory list
  - printing 50
- display brightness
  - adjusting 124
- Display Customization
  - using 19
- documents, printing
  - from a computer 45
  - from a mobile device 45, 46

## E

- Eco-Mode
  - configuring 124
- Eco-Settings
  - configuring 20
- editing contacts 23
- editing groups 23
- emission notices 211, 215, 218
- enabling Magnification mode 26

- enabling personal identification numbers 26
- enabling spoken passwords 26
- enabling the USB port 147
- encrypting the printer hard disk 96
- envelopes
  - loading 35
- environmental setting
  - Eco-Mode 124
  - Hibernate mode 124
  - sleep mode 124
- erasing memory
  - from the printer hard disk 95
- erasing non-volatile memory 95
- erasing printer hard disk memory 95
- erasing printer memory 95, 96
- erasing volatile memory 95
- Ethernet port 13
- exporting a configuration file
  - using the Embedded Web Server 208

## F

- factory default settings
  - restoring 96
- FCC notices 215
- finding more information about the printer 9
- firmware
  - update 208
- flash drive
  - printing from 46
- folder paper 158
- font sample list
  - printing 49
- fuser
  - replacing 109

## G

- Google Cloud Print
  - using 45
- groups
  - adding 23
  - deleting 23
  - editing 23

## H

- hardware options
  - installing 192, 197, 199, 201, 203, 205
  - memory card 188
  - trays 196
- hardware options, adding
  - print driver 208
- headphones
  - default volume 98
- held jobs 48
  - printing from a Macintosh computer 48
  - printing from Windows 48
- Hibernate mode
  - configuring 124
- high-capacity output expander
  - installing 201
- home screen
  - customizing 19
  - showing icons 19
  - using 18
- home screen icons 18
- hot roll fuser
  - replacing 111
- HTTP/FTP Settings menu 83
- humidity around the printer 213

## I

- icons on the home screen
  - showing 19
- identifying jam locations 128
- imaging unit
  - ordering 103
  - replacing 106
- importing a configuration file
  - using the Embedded Web Server 208
- indicator light
  - understanding the status 16
- installing a memory card 188
- installing an optional card 190
- installing options
  - printer hard disk 191
- installing the 2100-sheet tray 197
- installing the 4-bin mailbox 199
- installing the high-capacity output expander 201
- installing the output expander 201

- installing the printer software 207
- installing the staple finisher 203
- installing the staple, hole punch finisher 205
- installing trays 196
- internal option is not detected 148
- internal options
  - firmware card 187
  - flash memory 187
  - font card 187
  - internal solutions port 187
  - printer hard disk 187
- internal options, adding
  - print driver 208
- internal solutions port
  - installing 192

## J

- jams
  - avoiding 126
- jams, clearing
  - in the standard bin 134

## K

- keyboard on the display
  - using 26

## L

- letterhead
  - loading 35
  - loading, 2100-sheet tray 30
- Lexmark Mobile Print
  - using 45
- linking trays 36
- loading
  - 2100-sheet tray 30
  - letterhead in 2100-sheet tray 30
- loading the multipurpose feeder 35
- loading trays 27
- locating jam areas 128
- locating the security slot 95

## M

- Magnification mode
  - enabling 26
- maintenance kit
  - ordering 104

- managing screen saver 19
- memory card
  - installing 188
- menu
  - 802.1x 82
  - About this Printer 62
  - Accessibility 58
  - Confidential Print Setup 90
  - Device 93
  - Erase Temporary Data Files 92
  - Ethernet 77
  - Flash Drive Print 72
  - Google Cloud Print 84
  - Help 94
  - HTML 70
  - HTTP/FTP Settings 83
  - Image 70
  - Information Sent to Lexmark 58
  - IPSec 81
  - Job Accounting 66
  - Layout 63
  - Local Accounts 87
  - Login Restrictions 90
  - LPD Configuration 82
  - Manage Permissions 86
  - Media Types 72
  - Menu Settings Page 93
  - Miscellaneous 92
  - Mobile Services
    - Management 92
  - Network 94
  - Network Overview 74
  - Notifications 53
  - Out of Service Erase 62
  - PCL 68
  - PDF 67
  - PostScript 68
  - Power Management 57
  - Preferences 52
  - Print 93
  - Quality 65
  - Remote Operator Panel 53
  - Restore Factory Defaults 59
  - Security Audit Log 88
  - Setup 64
  - SNMP 80
  - Solutions LDAP Settings 91
  - TCP/IP 79
  - ThinPrint 83
  - Tray Configuration 71
  - Troubleshooting 94
  - Universal Setup 71
- USB 84
- Visible Home Screen Icons 62
- Wi-Fi Direct 85
- XPS 67
- Menu map 51
- Menu Settings Page
  - printing 94
- menus
  - Configuration Menu 60
  - Disk Encryption 91
  - Schedule USB Devices 87
  - Wireless 74
- mobile device
  - printing from 45, 46
- Mopria Print Service
  - using 45
- moving the printer 10, 123
- multipurpose feeder
  - loading 35
- N**
  - navigating the screen
    - using gestures 25
  - navigating the screen using gestures 25
  - noise emission levels 211
  - Non-Lexmark supply 150
  - non-volatile memory 96
  - Not enough free space in flash memory for resources 149
  - notices 211, 212, 213, 214, 215, 218
- O**
  - operating systems
    - supported 207
  - optional card
    - installing 190
  - ordering
    - maintenance kit 104
  - ordering supplies
    - imaging unit 103
    - staple cartridge 104
    - toner cartridge 101
  - output expander
    - installing 201
- P**
  - paper jam
    - in the duplex area 133
    - in the fuser 133
    - paper jam in door A 130
    - paper jam in door C 133
    - paper jam in door H 138
    - paper jam in door N 137
    - paper jam in the 4-bin mailbox 137
    - paper jam in the high-capacity output expander 136
    - paper jam in the multipurpose feeder 135
    - paper jam in the output expander 136
    - paper jam in the staple finisher bin 138
    - paper jam in trays 130
    - paper jams
      - avoiding 126
      - location 128
    - paper jams, clearing
      - in the standard bin 134
    - personal identification number method 99
    - personal identification numbers
      - enabling 26
    - pick roller
      - replacing 116
    - pick roller in the multipurpose feeder
      - replacing 117
    - power button light
      - understanding the status 16
    - power cord socket 13
    - prepunched paper
      - loading 35
    - print driver
      - hardware options, adding 208
    - print jobs not printed 183
    - Print Quality Test Pages 94
    - print quality troubleshooting
      - blank or white pages 154
      - crooked or skewed print 167
      - dark print 155
      - fine lines are not printed
        - correctly 157
      - folded or wrinkled paper 158
      - gray background on prints 159
      - horizontal light bands 173
      - light print 162
      - mottled print and dots 165
      - paper curl 166
      - repeating defects 179
      - solid black pages 168

- text or images cut off 170
- toner easily rubs off 172
- vertical dark bands 174
- vertical dark lines or streaks 177
- vertical dark streaks with print missing 178
- vertical light bands 173
- vertical white lines 174
- print troubleshooting
  - confidential and other held documents do not print 180
  - envelope seals when printing 151
  - incorrect margins 162
  - jammed pages are not reprinted 154
  - job prints from the wrong tray 185
  - job prints on the wrong paper 185
  - paper frequently jams 153
  - print jobs do not print 183
  - slow printing 181
  - tray linking does not work 152
  - unable to read flash drive 147
- printer
  - minimum clearances 10
  - moving 10
  - selecting a location 10
  - shipping 123
- printer configurations 11
- printer connectivity
  - checking 148
- printer hard disk
  - encrypting 96
  - installing 191
- printer hard disk memory 96
  - erasing 95
- printer information
  - finding 9
- printer is not responding 184
- printer messages
  - Defective flash detected 149
  - Non-Lexmark supply 150
  - Not enough free space in flash memory for resources 149
  - Replace cartridge, printer region mismatch 149
  - Unformatted flash detected 149
- printer options troubleshooting
  - cannot detect internal option 148
- printer port settings
  - changing 100
- printer ports 13
- printer settings
  - restoring factory default 96
- printer software, installing 207
- printer status 16
- printing
  - AirPrint 92
  - directory list 50
  - font sample list 49
  - from a Cloud Connector profile 49
  - from a computer 45
  - from a flash drive 46
  - Menu Settings Page 94
  - printing confidential and other held jobs
    - from a Macintosh computer 48
    - from Windows 48
  - printing from a computer 45
  - printing from a flash drive 46
  - Push Button method 99
- Q**
  - QR codes
    - adding 21
  - Quality menu 65
- R**
  - recycling
    - Lexmark packaging 125
    - Lexmark products 125
    - toner cartridges 125
  - removing paper jam
    - in door A 130
    - in door H 138
    - in door N 137
    - in high-capacity output expander 136
    - in mailbox bin 137
    - in the duplex unit 133
    - in the fuser 133
    - in the multipurpose feeder 135
    - in the output expander 136
    - in the staple finisher bin 138
    - in the staple, hole punch finisher 139
    - in the staple, hole punch finisher bin 139
    - in trays 130
  - removing staple jam 140, 143
  - repeat print jobs 48
    - printing from a Macintosh computer 48
    - printing from Windows 48
  - Replace cartridge, printer region mismatch 149
  - replacing
    - pick roller in the multipurpose feeder 117
  - replacing parts
    - fuser 109
    - hot roll fuser 111
    - pick roller 116
    - transfer roller 113
  - replacing supplies
    - imaging unit 106
    - staple cartridge 120, 121
    - toner cartridge 105
  - reserve print jobs
    - printing from a Macintosh computer 48
    - printing from Windows 48
  - resetting
    - supply usage counters 150
  - restoring factory default settings 96
  - running a slideshow 19
- S**
  - safety information 7, 8
  - scheduling power modes 20
  - securing printer memory 96
  - security slot
    - locating 95
  - selecting a location for the printer 10
  - setting the paper size 27
  - setting the paper type 27
  - setting up Device Quotas 20
  - shipping the printer 123
  - showing icons on the home screen 19
  - skewed print 167
  - sleep mode
    - configuring 124
  - speaker
    - default volume 98
  - spoken passwords
    - enabling 26
  - staple cartridge
    - ordering 104

- replacing 120, 121
- staple finisher
  - installing 203
- staple, hole punch finisher
  - installing 205
- statement of volatility 96
- status of parts
  - checking 101
- status of supplies
  - checking 101
- storing print jobs 48
- supplies
  - conserving 124
- supply notifications
  - configuring 105
- supply usage counters
  - resetting 150
- supported file types 47
- supported flash drives 47
- supported operating systems 207
- supported paper sizes 37
- supported paper types 40
- supported paper weights 42

**T**

- TCP/IP menu 79
- temperature around the printer 213
- toner cartridge
  - ordering 101
  - replacing 105
- toner cartridges
  - recycling 125
- toner darkness
  - adjusting 185
- transfer roller
  - replacing 113
- trays
  - loading 27
- troubleshooting
  - cannot open Embedded Web Server 146
  - printer is not responding 184
  - collated printing does not work 151
  - confidential and other held documents do not print 180
  - envelope seals when printing 151
  - incorrect margins 162

- jammed pages are not reprinted 154
- job prints from the wrong tray 185
- job prints on the wrong paper 185
- paper frequently jams 153
- print jobs do not print 183
- slow printing 181
- tray linking does not work 152

troubleshooting, print quality

- blank or white pages 154
- crooked or skewed print 167
- dark print 155
- fine lines are not printed correctly 157
- folded or wrinkled paper 158
- gray background on prints 159
- horizontal light bands 173
- light print 162
- mottled print and dots 165
- paper curl 166
- repeating defects 179
- solid black pages 168
- text or images cut off 170
- toner easily rubs off 172
- vertical dark bands 174
- vertical dark lines or streaks 177
- vertical dark streaks with print missing 178
- vertical light bands 173
- vertical white lines 174

troubleshooting, printer options

- cannot detect internal option 148

**U**

- unable to read flash drive
  - troubleshooting, print 147
- Unformatted flash detected 149
- Universal paper
  - configuring 27
- unlinking trays 36
- updating firmware
  - flash file 208
- USB port 13
  - enabling 147
- using
  - genuine Lexmark parts 101
  - genuine Lexmark supplies 101
  - using Customer Support 21
  - using Display Customization 19

- using QR Code Generator 21
- using the control panel
  - Lexmark M5255 16
  - Lexmark M5265 16
  - Lexmark M5270 16
  - Lexmark MS725 15
  - Lexmark MS821 15
  - Lexmark MS822 16
  - Lexmark MS823 15
  - Lexmark MS824 16
  - Lexmark MS825 15
  - Lexmark MS826 16
- using the home screen 18

**V**

- verify print jobs 48
  - printing from a Macintosh computer 48
  - printing from Windows 48
- vertical dark lines on prints 177
- vertical streaks on prints 177
- virtual keyboard
  - using 26
- Voice Guidance
  - activating 25
  - speech rate 26
- Voice Guidance speech rate
  - adjusting 26
- volatile memory 96

**W**

- white lines 174
- white pages 154
- Wireless menu 74
- wireless network
  - connecting the printer to 98
  - Wi-Fi Protected Setup 99
- wireless networking 98
- Wi-Fi network
  - deactivating 99
- Wi-Fi Protected Setup
  - wireless network 99
- wrinkled paper 158