

SERIES **5/6/7**
590
690
790

LED TV

Installation manual

imagine the possibilities

Thank you for purchasing this Samsung product.
To receive more complete service, please register
your product at

www.samsung.com/register

Model _____ Serial No. _____



Figures and illustrations in this User Manual are provided for reference only and may differ from actual product appearance. Product design and specifications may be changed without notice.

Instruction

This TV is provided with interactive functionality through a set-back box (SBB/STB) connected to the TV, and with other TVs in a computer controlled system for hotels and other hospitality businesses.

Interactive : When the TV is powered-up initially, it sends a command to identify the SBB/STB; if identified, the TV switches to ONLINE mode and full control is through the SBB/STB.

If the TV is in ONLINE mode, it stops receiving IR(Samsung remote) commands and acts according to interface protocol.

Stand-Alone: If SBB/STB is not identified, the TV should be switched to STAND-ALONE mode with restricted operation.

Operational Modes

When this TV (in Hotel mode) is operated with a SBB/STB, it is in one of two states

- ONLINE or STAND-ALONE. In the STAND-ALONE state, the TV will act as a Hotel TV, but without active communication. This is to prevent guests from trying to cheat the system by disconnecting the SBB/STB.

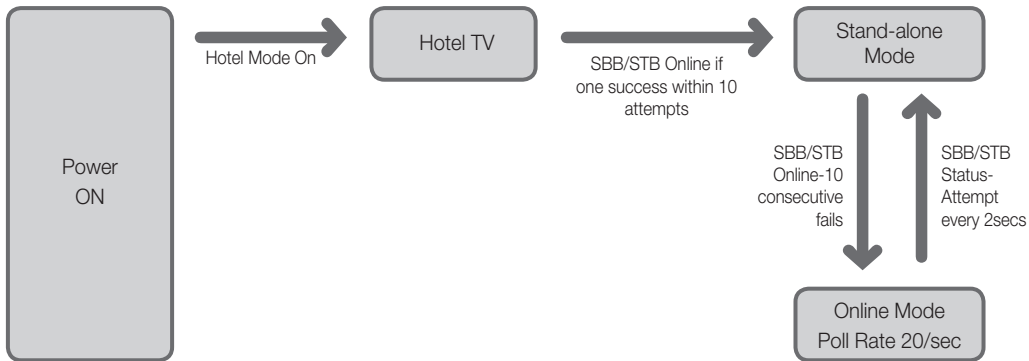

To set the details for Stand-alone or interactive mode, refer to pages 19-22(Setting the hotel option data : Stand-alone mode and Interactive mode)

- Some operations may be restricted to prevent guests from "cheating" the TV system.
- No main menu(Interactive mode) or Channel Menu, Plug & Play in Main Menu(Stand-Alone mode)
- Limited Volume and Panel key lock or unlock

Still image warning

Avoid displaying still images (like jpeg picture files) or still image element (like TV Program logo, panorama or 4:3 image format, stock or news bar at screen bottom etc.) on the screen. Constant displaying of still picture can cause uneven wear of screen phosphor, which will affect image quality. To reduce risk of this effect, please follow below recommendations:

- Avoid displaying the same TV channel for long periods.
- Always try to display any image on full screen, use TV set picture format menu for best possible match.
- Reduce brightness and contrast values to minimum required to achieve desired picture quality, exceeded values may speed up the burnout process.
- Frequently use all TV features designed to reduce image retention and screen burnout, refer to proper user manual section for details.

Securing the Installation Space

Keep the required distances between the product and other objects (e.g. walls) to ensure proper ventilation.

Failing to do so may result in fire or a problem with the product due to an increase in the internal temperature of the product.

- When using a stand or wall-mount, use parts provided by Samsung Electronics only.
 - If you use parts provided by another manufacturer, it may result in a problem with the product or an injury due to the product falling.
- The appearance may differ depending on the product.

Installation with a stand.

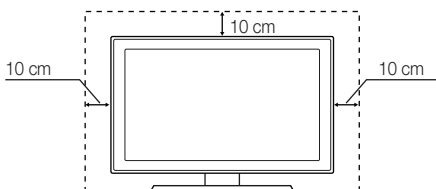

Installation with a wall-mount.

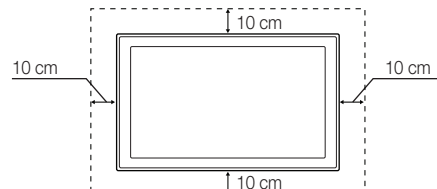

Contents

- Instruction..... 2
- Operational Modes 2
- Still image warning 2
- Securing the Installation Space 2
- Accessories 4
- Installing the LED TV Stand..... 5
- Viewing the Connection Panel..... 6
- TV Controller..... 10
- Viewing the Remote Control..... 11
- Connecting the TV with SBB..... 12
- Connecting the Bathroom Speakers 14
- Connecting the MediaHub HD 16
- Connecting the RJP (Remote Jack Pack)..... 17
- Setting the Hotel Option Data 19
- SIRCH 56
- Installing the Wall Mount 73
- Securing the TV to the Wall 73
- Anti-theft Kensington Lock..... 74
- Specifications 74

Accessories

 Please make sure the following items are included with your LED TV. If any items are missing, contact your dealer.

 The items' colour and shapes may vary depending on the models.

- Remote Control & Batteries (AAA x 2)
- Quick Set up Guide
- Safety Guide (Not available in all locations)
- Cleaning Cloth
- Power Cord / Data Cable

 The stand and stand screw may not be included depending on the model.

 The Data Cable may not be included depending on the SI Vendor.

Installing the LED TV Stand

The 32" and larger LED TVs have swivel stands. You can set these stands so that the TVs swivel 20 degrees left and right or 90 degrees left and right. The 26" LED TVs do not have swivel stands.

Stand Components

When installing the stand, use the provided components and parts.

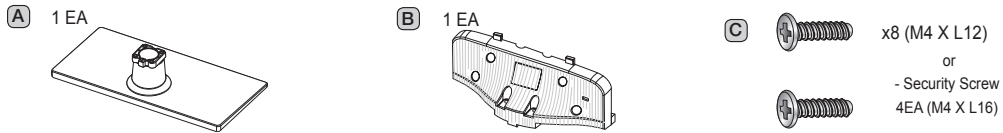

• Stand (depending on the model)

• Guide Stand

• Screws

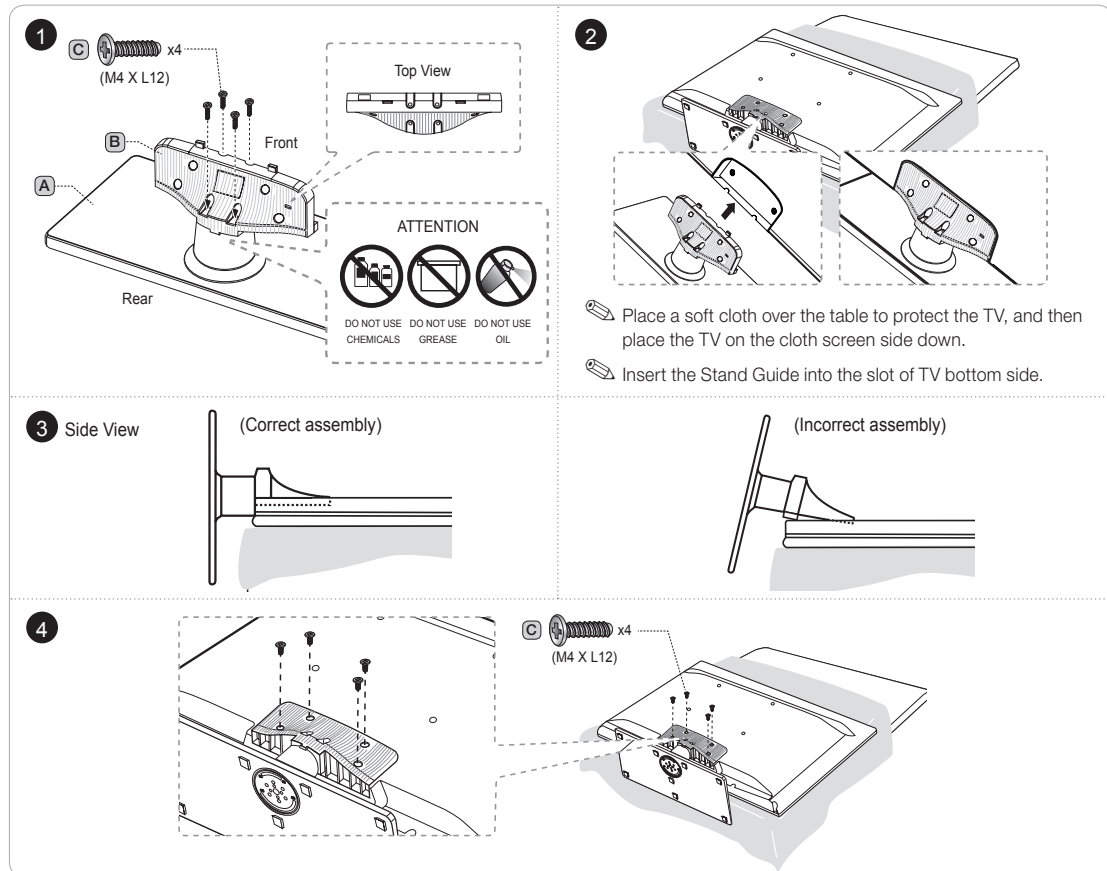

Make sure to distinguish between the front and back of the Stand and Stand Guide when assembling them.

Make sure that at least two people lift and move the TV.

Viewing the Connection Panel

<Europe Model>

HG32EA790**
 HG40EA790**
 HG46EA790**
 HG55EA790**
 HG32EA590**
 HG40EA590**
 HG46EA590**

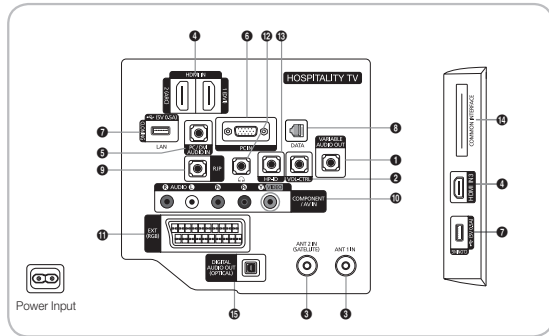

<ASIA DTV Model - except Middle ASIA Model>

HG32AA690**
 HG40AA690**
 HG46AA690**
 HG55AA790**

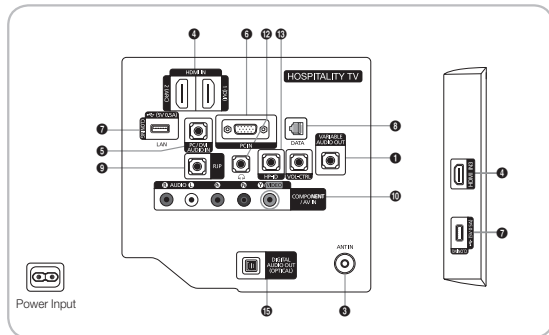

<Middle ASIA Model>

HG32AA690**
 HG40AA690**
 HG46AA690**
 HG55AA790**

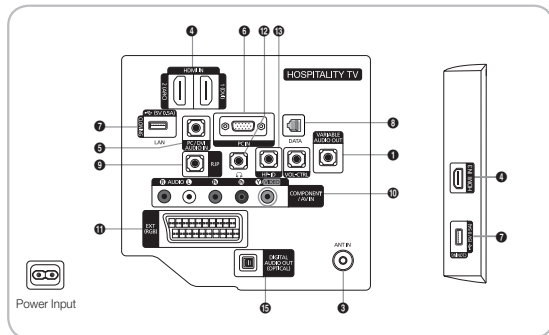

✎ Whenever you connect an external device to your TV, make sure that power on the unit is turned off.

✎ When connecting an external device, match the color of the connection terminal to the cable.

- ❶ **VARIABLE AUDIO OUT:** Used for the audio output to the Bathroom speaker. Connect the Bathroom Wall Box and the Variable port (RCA). (Not available for 22 inch model.)
- ❷ **VOL-CTRL:** Used to control the volume of the Bathroom speaker. Connect the Bathroom Wall Box and the VOL-CTRL port.
- ❸ **ANT 1 IN, ANT 2 IN(SATELLITE), ANT 2 IN(CABLE):** To view television channels correctly, a signal must be received by the set from one of the following sources. An outdoor antenna / A cable television network / A satellite network.
 - ✎ **For Norway & For Sweden:** Equipment which is connected to protective earth through a network plug and/or through other equipment connected to earth, and connected to a cable network, may cause risk of fire. To prevent this from happening, a galvanic isolator is also installed between the equipment and the cable network when connecting the equipment to the cable network.
- ❹ **HDMI IN 1(DVI), 2(ARC), 3:** Connects to the HDMI jack of a device with an HDMI output.
 - ✎ No sound connection is needed for an HDMI to HDMI connection.
 - ✎ Use the **HDMI IN 1(DVI)** jack for DVI connection to an external device. Use a DVI to HDMI cable or DVI-HDMI adapter (DVI to HDMI) for video connection and the **PC/DVI AUDIO IN** jacks for audio.
- ❺ **PC/DVI AUDIO IN:** Connect to the audio output jack on your PC.
- ❻ **PC IN:** Connect to the video output jack on your PC.

Display Modes

Both screen position and size will vary depending on the type of PC monitor and its resolution.

The resolutions in the table are recommended.

✎ Optimal resolution is 1360 X 768 @ 60 Hz.

Mode	Resolution	Horizontal Frequency (KHz)	Vertical Frequency (Hz)	Pixel Clock Frequency (MHz)	Sync Polarity (H / V)
IBM	640 x 350	31.469	70.086	25.175	+/-
	720 x 400	31.469	70.087	28.322	-/+
MAC	640 x 480	35.000	66.667	30.240	-/-
	832 x 624	49.726	74.551	57.284	-/-
VESA CVT	720 x 576	35.910	59.950	32.750	-/+
	1280 x 720	56.456	74.777	95.750	-/+
VESA DMT	640 x 480	31.469	59.940	25.175	-/-
	640 x 480	37.500	75.000	31.500	-/-
	640 x 480	37.861	72.809	31.500	-/-
	800 x 600	37.879	60.317	40.000	+/+
	800 x 600	46.875	75.000	49.500	+/+
	800 x 600	48.077	72.188	50.000	+/+
	1024 x 768	48.363	60.004	65.000	-/-
	1024 x 768	56.476	70.069	75.000	-/-
	1024 x 768	60.023	75.029	78.750	+/+
	1280 x 720	45.000	60.000	74.250	+/+
VESA GTF	1360 x 768	47.712	60.015	85.500	+/+
VESA GTF	1280 x 720	52.500	70.000	89.040	-/+

 Optimal resolution is 1920 X 1080 @ 60 Hz.

Mode	Resolution	Horizontal Frequency (KHz)	Vertical Frequency (Hz)	Pixel Clock Frequency (MHz)	Sync Polarity (H / V)
IBM	640 x 350	31.469	70.086	25.175	+/-
	720 x 400	31.469	70.087	28.322	-/+
MAC	640 x 480	35.000	66.667	30.240	-/-
	832 x 624	49.726	74.551	57.284	-/-
	1152 x 870	68.681	75.062	100.000	-/-
VESA CVT	720 x 576	35.910	59.950	32.750	-/+
	1152 x 864	53.783	59.959	81.750	-/+
	1280 x 720	56.456	74.777	95.750	-/+
	1280 x 960	75.231	74.857	130.000	-/+
VESA DMT	640 x 480	31.469	59.940	25.175	-/-
	640 x 480	37.861	72.809	31.500	-/-
	640 x 480	37.500	75.000	31.500	-/-
	800 x 600	37.879	60.317	40.000	+/+
	800 x 600	48.077	72.188	50.000	+/+
	800 x 600	46.875	75.000	49.500	+/+
	1024 x 768	48.363	60.004	65.000	-/-
	1024 x 768	56.476	70.069	75.000	-/-
	1024 x 768	60.023	75.029	78.750	+/+
	1152 x 864	67.500	75.000	108.000	+/+
	1280 x 1024	63.981	60.020	108.000	+/+
	1280 x 1024	79.976	75.025	135.000	+/+
	1280 x 720	45.000	60.000	74.250	+/+
	1280 x 800	49.702	59.810	83.500	-/+
	1280 x 800	62.795	74.934	106.500	-/+
	1280 x 960	60.000	60.000	108.000	+/+
1360 x 768	47.712	60.015	85.500	+/+	
1440 x 900	55.935	59.887	106.500	-/+	
1440 x 900	70.635	74.984	136.750	-/+	
1680 x 1050	65.290	59.954	146.250	-/+	
VESA GTF	1280 x 720	52.500	70.000	89.040	-/+
	1280 x 1024	74.620	70.000	128.943	-/-
VESA DMT / DTV CEA	1920 x 1080p	67.500	60.000	148.500	+/+

 When using an HDMI/DVI cable connection, you must use the **HDMI IN 1 (DVI)** jack.

 The interlace mode is not supported.

 The set might operate abnormally if a non-standard video format is selected.

 Separate and Composite modes are supported. SOG is not supported.

7 USB (5V 0.5A) / CLONING

- Connector for software upgrades and **My Downloads**, etc.
- Service connection.

8 DATA

- Used to support data communication between the TV and the SBB.
- The TV jack type is RJ-12.

9 RJP: This port is an RJP (Remote Jack Pack) communication port that enables connecting different devices to additional module so as to improve device use convenience.

10 COMPONENT IN / AV IN 1, AV IN 2

- Connects Component video / audio.
- Connect component video cables (optional) to the component jacks ("P_R", "P_B", "Y") on the rear of your TV and the other ends to corresponding component video out jacks on the DVD.
- If you wish to connect both the Set-Top Box and DVD, you should connect the Set-Top Box to the DVD and connect the DVD to the component jacks ("P_R", "P_B", "Y") on your TV.
- The P_R, P_B and Y jacks on your component devices (DVD) are sometimes labeled Y, B-Y and R-Y or Y, Cb and Cr.
- Connect RCA audio cables (optional) to [R - AUDIO - L] on the rear of the TV set and the other ends to corresponding audio out jacks on the DVD.

11 EXT (RGB)

Connector	Input			Output
	Video	Audio (L/R)	RGB	Video + Audio (L/R)
EXT	0	0	0	Only TV or DTV output is available

 Inputs or outputs for external devices, such as VCR, DVD, video game device or video disc players.

12 HEADPHONE JACK

- Headphones may be connected to the headphone jack on your TV. While the headphones are connected, the sound from the built-in speakers will be disabled.





13 HP-ID

14 COMMON INTERFACE





15 DIGITAL AUDIO OUT (OPTICAL): Connects to a Digital Audio component.

TV Controller

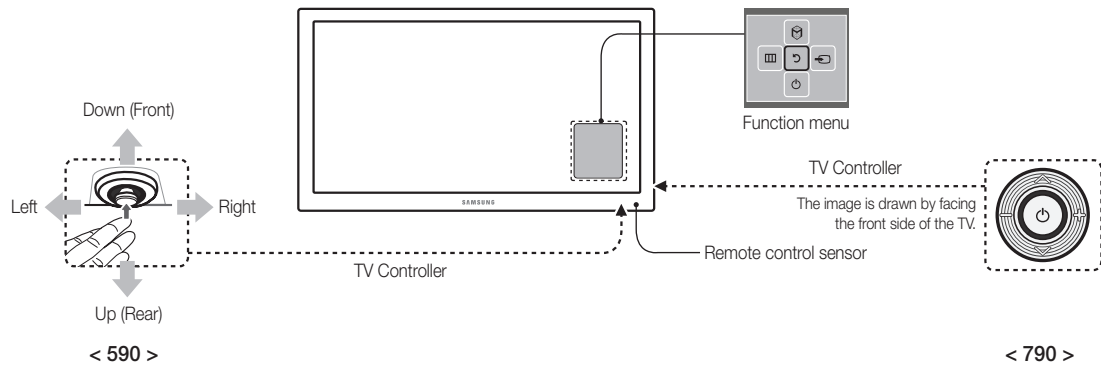
TV Controller is a multi directional button that helps navigate without remote control.

-  Some functions which require a PIN code may not be available.
-  The product colour and shape may vary depending on the model.
-  Exits the menu when pressing the controller more than 1 second.
-  When selecting the function by moving the controller to the up/down/left/right directions, be sure not to press the controller. If you press it first, you cannot operate it to move the up/down/left/right directions.



Power on	Turns the TV on by pressing the controller in standby mode.
Adjusting the volume	Adjusts the volume by moving the controller from side to side when the power is on.
Selecting a channel	Selects a channel by moving the controller up and down when the power is on.
Using the function menu	Press the controller when the power is on, then the function menu screen appears. If you press it again, the function menu screen disappears.
Using the Menu	Selects the MENU () by moving the controller in the function menu screen. The OSD(On Screen Display) of your TV's feature appears.
Selecting the Source	Selects the Source () by moving the controller in the function menu screen. The Source list screen appears.
Selecting the Contents Home	Selects the Contents Home () by moving the controller in the function menu screen. The Contents Home main screen appears.
Power Off	Selects the Power Off () to turn the TV off by moving the controller in the function menu screen.

Standby mode

Do not leave your TV in standby mode for long periods of time (when you are away on a holiday, for example). A small amount of electric power is still consumed even when the power button is turned off. It is best to unplug the power cord.

Viewing the Remote Control

This is a special remote control for the visually impaired persons and has Braille points on the Power, Channel and Volume buttons.

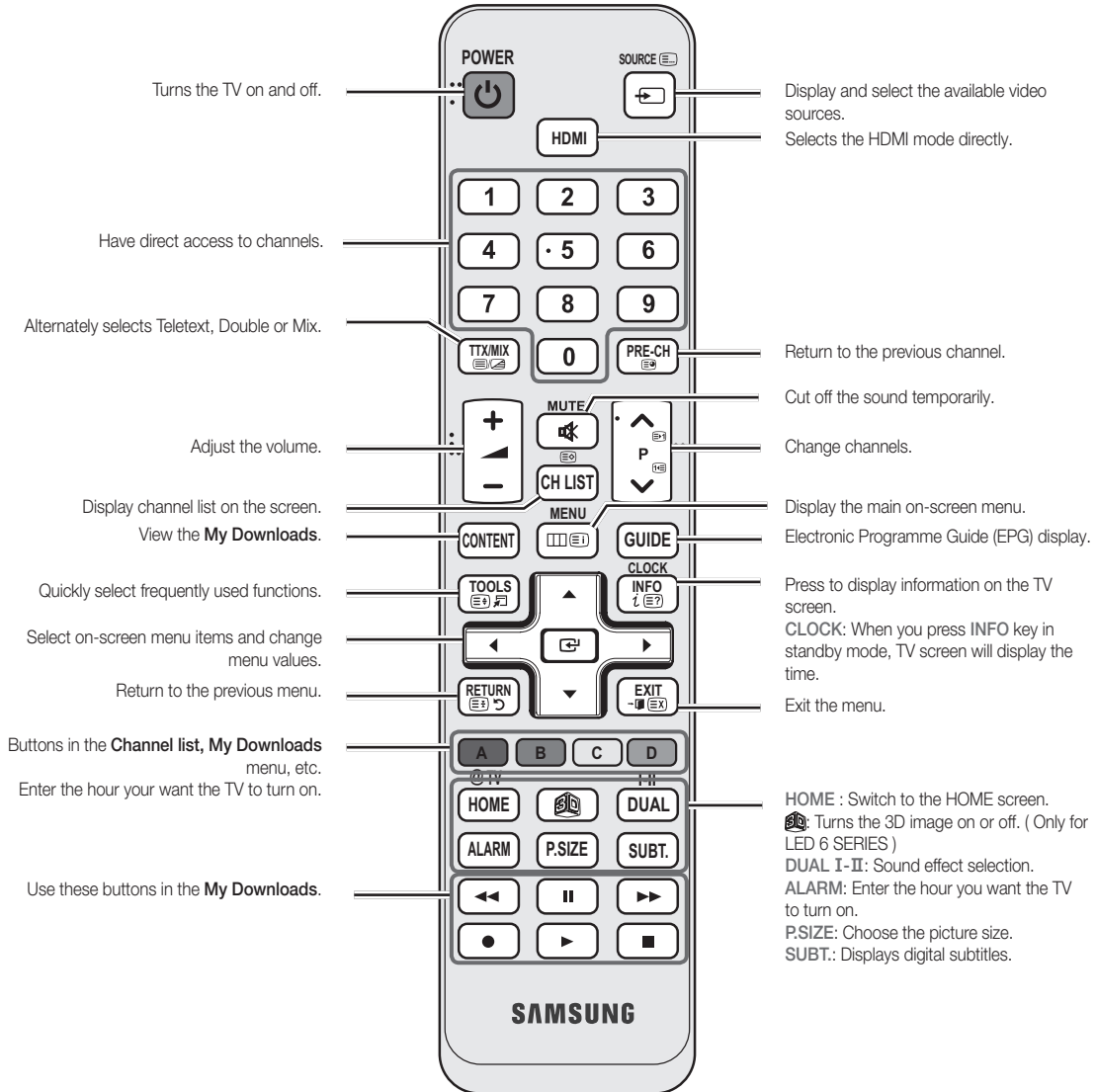

Installing batteries (Battery size: AAA)

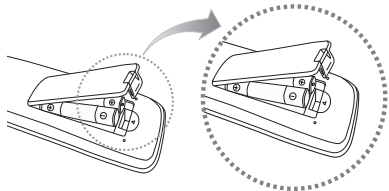

NOTE

- Use the remote control within 23 feet from the TV.
- Bright light may affect the performance of the remote control. Avoid using nearby special fluorescent light or neon signs.
- The colour and shape may vary depending on the model.
- Remocon button 'HOME' & '3D' is not supported. When press those button, TV unit do not give ANY respond.

Connecting the TV with SBB

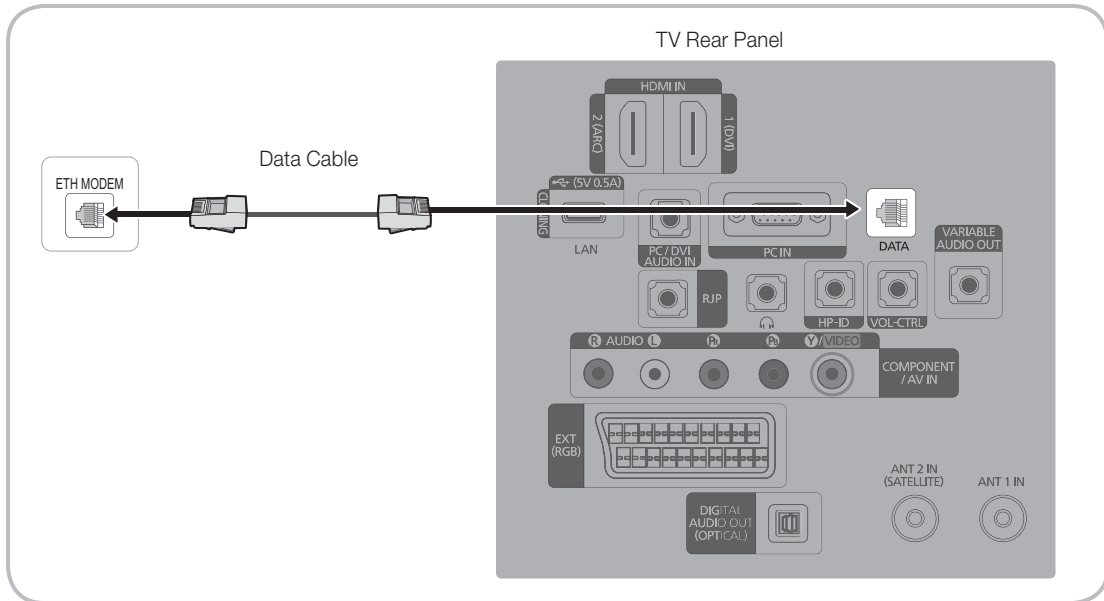

1. Connect the **DATA** jack of the TV to the [ETH MODEM] jack of the STB (SBB) with the Data cable.

 Use data communication.

List of Vendors and Compatible Data Cables Supplied with the TV

- Confirm you are using the correct data cable for your vendor. Refer to the code label on the data cables.

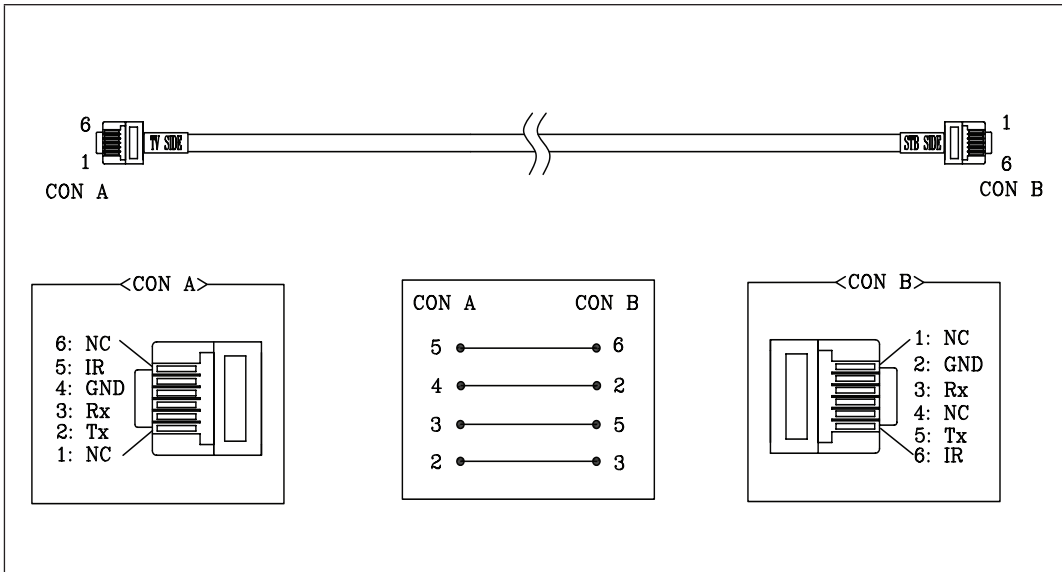

Connecting the Bathroom Speakers

You can connect the Bathroom Speakers in the following method.

Connecting through the Variable Output (available without an external amplifier)

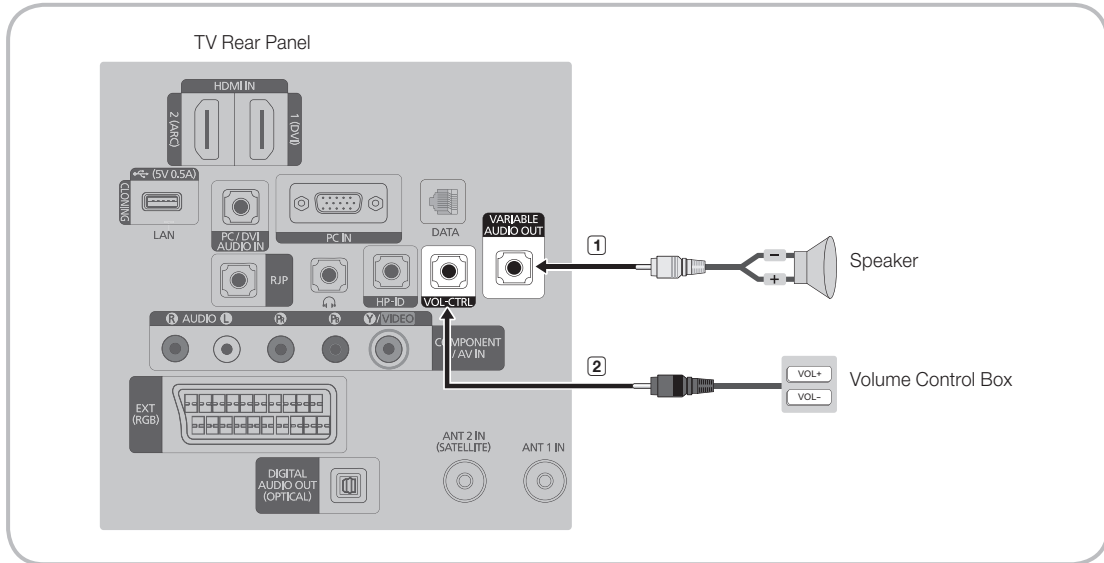

1. Connect the **VARIABLE AUDIO OUT** port of the TV to the Bathroom Wall Speakers of the hotel.

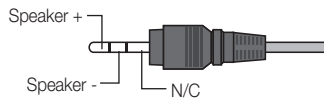

2. Connect the **VOL-CTRL** jack of the TV to the Volume Control Box Switch port on the Bathroom Wall of the hotel.

The maximum speaker output is 4W, 8Ω.

- Installing the Volume Control
 - If you configure the Volume Control Box as shown in the figure, you can control the volume of the bathroom speakers.
 - The jack that is connected from the Volume Control Box to the TV is a 3.5mm normal Phone jack.
 - Volume Control Box switch consists of Tact switch.
 - Setting the Sub AMP Mode
 - **0**: Turns the Sub AMP function off (PWM off).
 - **1**: Determines the Sub volume according to the main volume control. That is, the sub volume is determined according to the Power On Volume, the Min Volume, and the Max Volume values of the Hotel Mode.
 - **2**: Determines the volume according to the bathroom control panel setting.
- Variable Output Port Specifications
 - **Speaker Wire**: Use speaker cable no more than 82 feet (25m) in length.

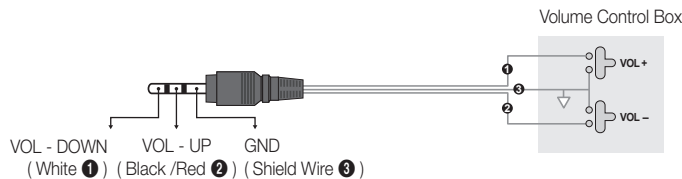

Audio Loop In

An additionally created Headphone Box can be installed on a bed or business desk so that users can use it conveniently. The installation procedures are given below.

- Detailed Drawing of the Headphone Box.

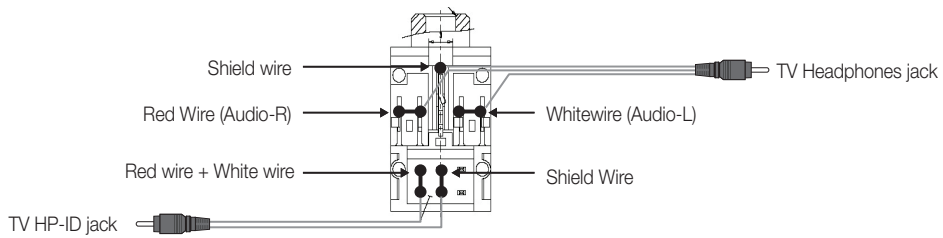
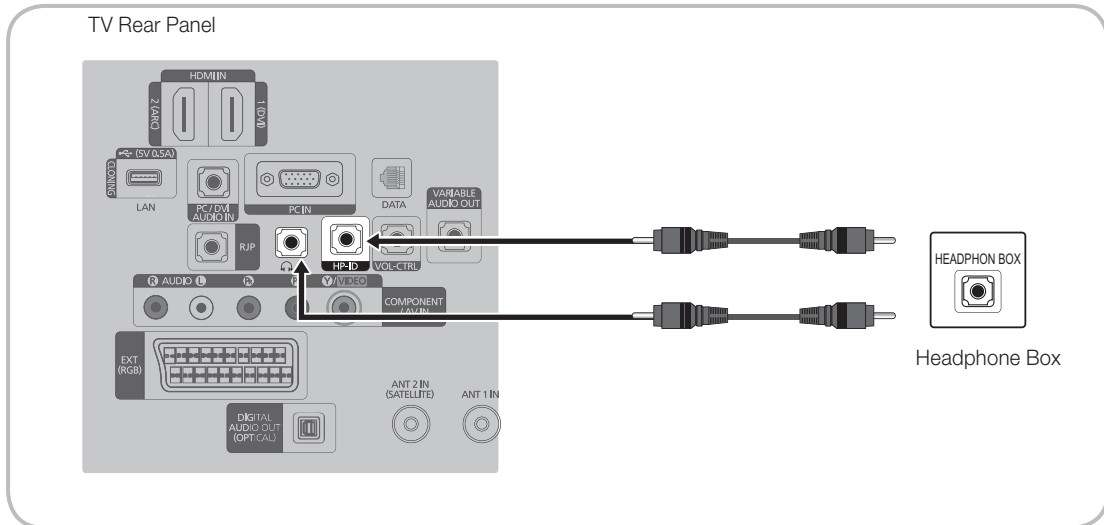

Connecting the MediaHub HD

Output of any external source connected to MediaHub HD on hotel desk.

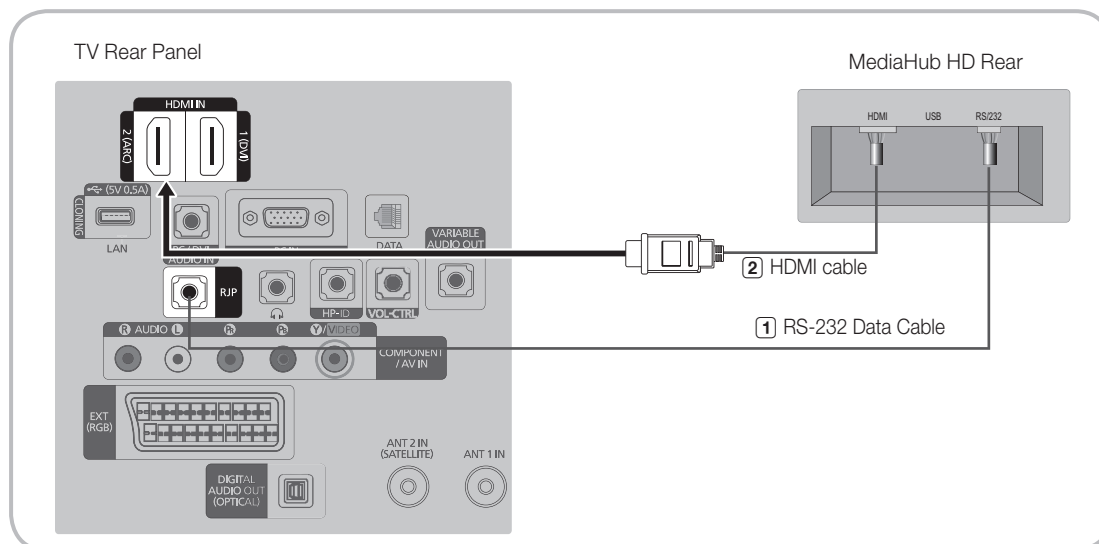

1. Connect the RJP port of the TV and the RS/232 port of the MediaHub HD.
2. Connect the HDMI IN (1(DVI) or 2) port of the TV and the HDMI port of the MediaHub HD.

- MediaHub HD
 - The MediaHub HD is a hardware module that has different Audio Video inputs (A/V, Audio, PC, HDMI and USB) and corresponding outputs. The corresponding output sources are connected from MediaHub to TV. The MediaHub communicates with the TV via RS232. Hot Plug & Play is a function that allows hotel guests to connect an external source to the MediaHub. The MediaHub communicates with the TV by sending messages regarding Active/Inactive sources. The TV will switch to the Active external source.
 - You have to connect the HDMI of the MediaHub to the **HDMI IN 1(DVI)** port of the TV.
 - When the TV is on, connect the TV and the RJP within 10 seconds.
- Special features
 - PIP
 - Auto Detection

Connecting the RJP (Remote Jack Pack)

Output of any external source connected to RJP on hotel desk.

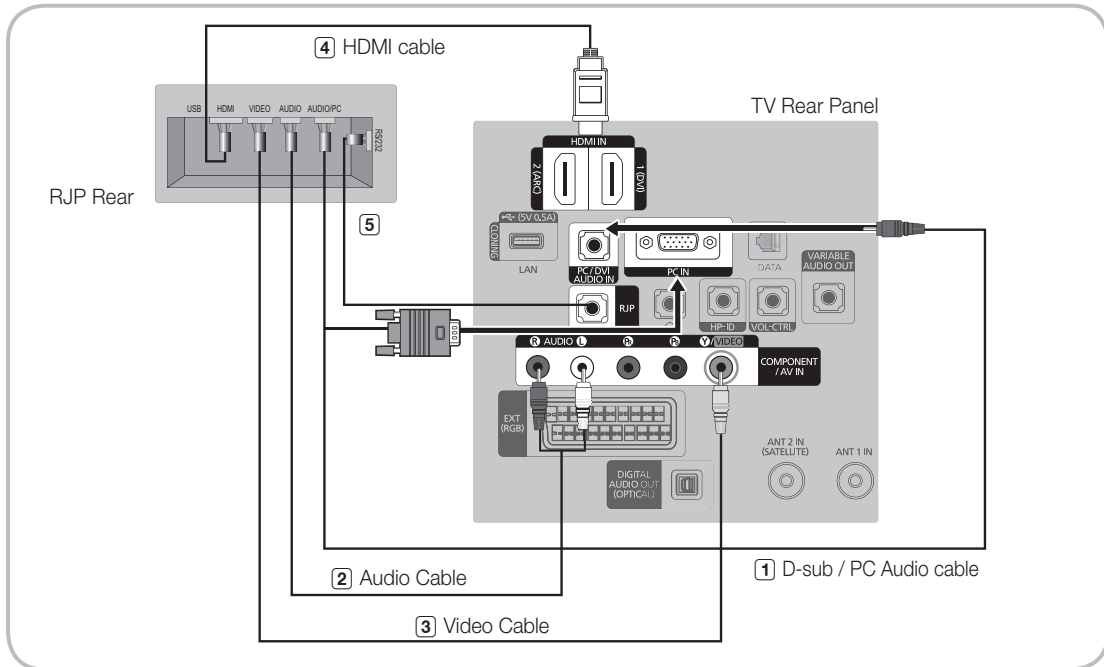

1. Connect the PC IN / PC/DVI AUDIO IN port of the TV to the PC/AUDIO port of the RJP.
2. Connect the AV IN [VIDEO]/[L-AUDIO-R] port of the TV to the VIDEO port of the RJP.
3. Connect the AV IN [VIDEO] port of the TV to the VIDEO port of the RJP.
4. Connect the HDMI IN (1(DVI), 2 or 3) port of the TV and the HDMI port of the RJP.
5. Connect the RJP port of the TV and the RS/232 port of the RJP.

The RJP (Remote Jack Pack) compatible with this Samsung TV is TeleAdapt TA-7610, TA-7650 (HD) and TA-7660 (HD Plus).

- **RJP (Remote Jack Pack):** RJP stands for Remote Jack Pack. The RJP is a hardware module that has different Audio Video inputs (A/V, Audio, PC and HDMI) and corresponding outputs. The corresponding output sources are connected from RJP to TV. The RJP communicates with the TV via RS232. Hot Plug & Play is a function that allows hotel guests to connect an external source to the RJP. The RJP communicates with the TV by sending messages regarding Active/Inactive sources. The TV will switch to the Active external source according to the priority set by the User.
 - You can select HDMI IN (1(DVI), 2 or 3) and AV IN for connecting RJP.

 When the TV is on, connect the TV and the RJP within 10 seconds.

- The RJP can be returned to the factory default settings by pressing the AV and HDMI buttons simultaneously for 10 seconds. All LEDs blink 5 times to Acknowledge that the rest has been performed.
- The RJP will automatically turn off any LEDs after 5 minutes to avoid unnecessary light pollution in the hotel room. The LEDs that were turned off will turn on again if the guest touches any of the buttons and the 5 minute timer will restart. If the guest then touches another source button, the TV will change to the selected source and the corresponding LED will be lit.
- After an RJP Reset or a TV Power OFF/ON, it takes approx. 10 seconds to establish communications between the TV and the RJP.
- The following table shows the approximate time in seconds to switch from the TV to the input source, based on the priority.

 Scenario 1: When no inputs are connected.

Source	To Connect
AV	2 Sec
PC	0.7 Sec
HDMI	3.9 Sec

 Scenario 2: When two or more inputs are connected and an Input source is disconnected and then reconnected.

Source	Disconnect	To Connect	Total
AV	4.5 Sec	2 Sec	6.5 Sec
PC	0.7 Sec	0.7 Sec	1.4 Sec
HDMI	3.9 Sec	3.9 Sec	7.8 Sec

 E.g. If the RJP has all its live sources AV, PC and HDMI connected, AV is viewed as the highest priority. If the RJP is in HDMI mode, and a guest removes and reconnects the AV, the minimum time required to switch to the AV is 6.5 seconds.

- To connect audio (Ipod or Mp3), Music mode should be ON and Jack Ident detect should be OFF.
- AV, PC and HDMI input sources are supported.

Setting the Hotel Option Data

To Enter: Press the MUTE → 1 → 1 → 9 → ENTER buttons in order. (From the Hospitality mode, the Standalone mode is set.)

To Exit from this menu : power off and turn on again.

No	Hotel TV Function			Description
	Category		initial value	
1	Hospitality Mode	-	Standalone	Select the Hotel TV mode. (Standalone / Interactive)
2	SI Vendor	-	OFF	Select the SI Vendor
3	Power On	Power On Channel EN	User Defined	TV will turn on to particular Channel.
		Power On Channel	1	TV will turn on to this particular Channel.
		Channel Type	ATV	Provides channel Type description for Power On channel selected. i.e. Selected channel analog or Digital & antennae selection(Air or Cable).
		Power On Volume EN	User Defined	TV will turn on with this Volume Level.
		Power On Volume	10	TV will turn on with this Volume Level.
		Min Volume	0	Minimum Volume Level setting user can set
		Max Volume	100	Maximum Volume Level setting user can set
		Power on source	TV	Select the Input source when TV is turned on initially.
	Power On Option	Last Option	Power On(AC Power On) Option - STN-BY : Stand-By Mode - Power On : Power On - LAST OPT : Last Power State	
4	Channel	Channel Setup	-	User can set channel option. Such as Auto Tunning, Manual Tunning, Antenna setting.
		Channel Editor	-	Provided option for editing Channel Name and Number and video. Mute settings for channels in channel List.
		Mixed Channel Map	OFF	Mix Analogue and Digital Channels
		Dynamic SI	OFF	On : No Check of the DTV Program channel number. (DTV channel editor accessible, but additional channel Program number update not supported) Off : Check the DTV Program channel number. (DTV channel editor inaccessible)
		Channel Rescan Message	ON	This is a display option for the OSD text that appears when a user configures the country specifications in hotel models. This option determines whether to activate the items that are only executed after a manual user confirmation when the notification message is displayed while the country specifications are being configured. On - When TV has an event for setting change because of country spec, It will be shown on the screen. Off - Even TV has an event for setting change, because of country spec, it will not be shown on the screen.
		Pan Euro MHEG	OFF	If Pan EURO MHEG is set to On, MHEG is On regardless of the product specifications or region. (Even if the region does not support MHEG, it is supported in case the hotel supports MHEG.)

No	Hotel TV Function			Description
	Category		initial value	
5	My Channel	My channel En	OFF	Set the My channel function ON/OFF .
		Genre Editor		User can set the genre for searched channel.
6	Menu OSD	Picture Menu Lock	OFF	Provided option for editing Channel Name and Number and video. Mute settings for channels in channel List.
		Menu display	ON	- On : Main Menu display - Off : Main Menu No display
7	Operation	Panel Button Lock	Unlock	Front panel(Local key) operation on/off - Unlock: Unlock All panel key - Lock: Lock All panel key - OnlyPower : Lock All panel key except Power panel key
		Subtitle Auto On	OFF	Set the automatically subtitle on function when user set the nation to France.
8	Clock	Local time	Manual	Selection of the way to update clock data - Manual: Use clock data from DVB channel or manual clock setting When the TV is in the stand-alone mode. - TTX: manual clock setting (with updating from TTX data).
9	Music Mode	Music Mode AV	OFF	To get music output from mp3/audio player in AV Input Source. Audio enabled, video disabled in this mode
		Music Mode PC	OFF	To get music output from mp3/audio player in PC Input Source. Audio enabled, video disabled in this mode.
		Music Mode Comp	OFF	To get music output from mp3/audio player in Component Input Source. Audio enabled, video disabled in this mode
		Music Mode Backlight	OFF	Backlight On/Off option in Music mode to save energy
10	External Device	7610 Priority AV	1	If the jack priority is set, the corresponding source is automatically set when a jack is inserted according to the jack priority
		7610 Priority PC	2	If the jack priority is set, the corresponding source is automatically set when a jack is inserted according to the jack priority.
		7610 Priority HDMI	3	If the jack priority is set, the corresponding source is automatically set when a jack is inserted according to the jack priority.
		7610 AV Option	AV1	Select RJP AV Source (AV1).
		RJP HDMI Option	HDMI1/DVI	Select RJP HDMI Source (HDMI1/HDMI2/HDMI3).
		Sound Bar Out	OFF	-

No	Hotel TV Function			Description
	Category		initial value	
11	External Source	USB Media Mode	Default	Control Pop-Up menu at USB insert to TV.
		External Source Banner	ON	Users can set External Source Banner to On or Off. On : When TV power On or Mode changed, TV will display the external source banner. Off : When TV power On or Mode changed, TV will not display the external source banner.
		Auto Source	OFF	While TV is in power on state, if PC source is connected to TV, TV will automatically switch to PC mode.
		Anynet+ Return Source	Power On Src	Set the return source after closing Anynet+.
12	Bathroom Speaker	Sub AMP mode	2	Determines the Sub AMP operation mode. - 0: Turns the Sub AMP function off (PWM off). - 1: Determines the Sub volume according to the main volume control. That is, the sub volume is determined according to the Power On Volume, the Min Volume, and the Max - 2: Determines the volume according to the bathroom control panel setting.
		Sub AMP volume	6	Sub AMP Volume level at power on initial condition.
13	Eco Solution	Energy Saving	Off	This feature adjusts the brightness of the TV in order to reduce power consumption. - Off: Turns off the energy saving function. - Low: Sets the TV to low energy saving mode. - Medium: Sets the TV to medium energy saving mode. - High: Sets the TV to high energy saving mode. - Auto: Sets the TV to automatically energy saving mode.
14	Logo/Message	Welcome message	OFF	Display Welcome Message.
		Edit Welcome Message		Edit Welcome Message.
		Hospitality Logo	OFF	Use can set the logo display Off or the type of logo file (BMP/AVI).
		Hospitality Logo DL	-	Download the logo file from USB toTV.
		Logo Display Time	5 Seconds	Set the logo display time (3/5/7 Seconds).
15	Cloning	Clone TV to USB	-	USB Clone: TV → USB
		Clone USB to TV	-	USB Clone: USB → TV
		Setting Auto Initialize	OFF	When Setting Auto Initialize is set to On, and the power is turned off and on or the Master Power is turned off and on, the data is restored to the cloned values. If there is no cloned value, even when the Setting Auto Initialize is set to On, it will be ignored and the operation will be the same as that when Setting Auto Initialize is set to Off

No	Hotel TV Function		Description	
	Category	initial value		
16	SIRCH	SIRCH Update Time	1hour	Standby SIRCH will be operated, according to time setting
		SIRCH Update Immediate	OFF	Make TV operate SIRCH after 1 minute in Stand-by mode.
		Manual SIRCH	-	Make TV operate SIRCH by manually
		SIRCH Channel	87	Set the default channel for SIRCH - None : After Auto Scan, Operate SIRCH - Channel value : Operate SIRCH at the channel selected
		SIRCH Version	0	Display SIRCH version of TV
		SIRCH Group ID	All	Provided SIRCH ID for operating SIRCH on a specific set.
		REACH	OFF	Set whether to use REACH function.
17	Network	Network Setup	-	Set an IP address to establish an Internet connection.
		Hotel ID Setting	-	Set a Hotel ID.
		Smart Hub	-	Enter the Smart Hub.
18	SERVICE	Self Diagnosis		Enter Self Diagnosis Menu. <ul style="list-style-type: none"> Picture Test: Use to check for picture problems. If the problem appears in the test picture, select Yes and follow the directions on the screen. Sound Test: Use the built-in melody sound to check for sound problems. If the problem occurs during the test, select Yes and follow the directions on the screen.
		SW Upgrade		SW USB Update function
		Service Pattern		Same function with SVC Service Pattern
		TV Reset		Factory reset

Welcome Message

Welcome message is a feature to display custom message on TV, every time TV is turned on by Guest in Hotel room.

- Welcome message settings are placed in Hotel Option Menu.
- Welcome message should be ON in order to display the message on power on.

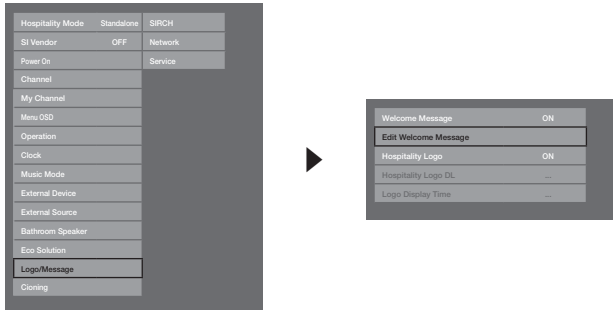

- Welcome message can be of 25 characters and it can be edited by changing its text in Hotel Service menu.
- Following is the list of characters supported for Welcome message:
✎ In letters from A to Z only in capital letters is allowed.
- Welcome message can be edited by using navigation, color & enter key of a Remote in "Edit Welcome Message" OSD.



- Welcome message and hotel logo cannot be active at the same time.

Hotel Logo

The Hospitality Logo function displays the Hotel's picture image when the TV is powered on.

- Hospitality Logo settings are in the Hospitality mode menus.
- The Logo Download and Logo Display Menu items are enabled when you turn the Hospitality Logo option on.
- If there is a logo image stored in the memory and Hospitality Logo option is on, the Hospitality logo is displayed when the TV is turned on.
- The Hospitality logo is not displayed when the Hospitality Logo option is off, even if the logo image has been loaded into the TV.

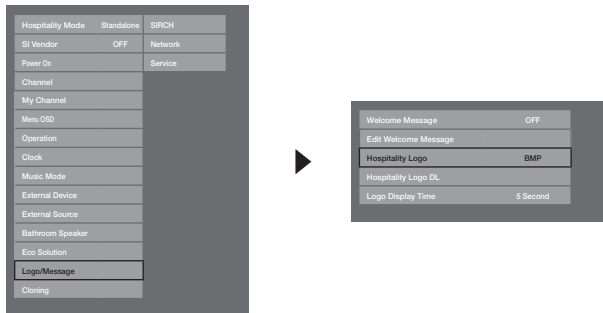

• Hospitality Logo

- This option lets you choose whether the Hospitality Logo image is displayed or not.
- Initial value is OFF.
- Can be set to OFF or ON.
- When set to ON, the Logo Download and Logo Time Display menu items become accessible.

• Hospitality Logo

- This option lets you choose whether the Hospitality Logo image is displayed or not.
- Initial value is OFF.
- Can be set to OFF or ON.
- When set to ON, the Logo Download and Logo Time Display menu items become accessible.

• Logo File Format

- This option lets you download the logo image to the TV's memory from a USB device.
- Wait appears while the image is being copied to the TV.
- Completed appears when the copy operation has finished successfully.
- Failed appears when the copy operation was unsuccessful.
- No USB appears if no USB device is connected.
- No File appears if there is no file to copy on the USB device or the file is in the wrong format (must be a BMP file). If No File appears and you have a logo file on the USB device, check the file format.

• Logo File Format

- The TV supports only the BMP and AVI format.
- The file name must be samsung.bmp or samsung.avi.
- The maximum resolution of the BMP format is 1280 x 720.
- The maximum file size of AVI format is 50MB.
- The TV does not change the size or scale of the image.

USB Cloning

USB Cloning is a function to download user configured settings (**Picture, Sound, Input, Channel, Setup, and Hotel Setup**) from one TV set and upload the same to other TV sets.

All the user-defined settings from the TV (Master Set) can be copied to the USB device.

- **Cloning from TV to USB:** It is an operation to copy the stored data from the specific area on the EEPROM from the TV set to the USB device.

1. Insert a USB drive into the USB port on the rear of the TV.
2. Enter the Interactive menu by pressing this buttons in order.
 - **MUTE** → 1 → 1 → 9 → **ENTER**
3. Press the **▲** or **▼** button to select “Clone:TV to USB”, then press the **ENTER** button.
4. The message “Clone:TV to USB” is displayed, then press the **ENTER** button.
5. You can Make sure USB cloning behavior.
 - **In Progress:** during copying data to USB.
 - **Completed:** copy operation was finished successfully.
 - **Failed:** copy operation was not finished successfully.
 - **No USB:** any USB is not connected.



- **Cloning from USB to TV:** It is an operation to download the stored data in USB device to TV set.

1. Insert a USB drive into the USB port on the rear of the TV.
2. Enter the Interactive menu by pressing this buttons in order. **MUTE** → 1 → 1 → 9 → **ENTER**
3. Press the **▲** or **▼** button to select “Clone:USB to TV”, then press the **ENTER** button.
4. The message “Clone:USB to TV” is displayed, then press the **ENTER** button.
5. You can Make sure USB cloning behavior.
 - **In Progress:** during copying data to TV.
 - **Completed:** copy operation was finished successfully.
 - **Failed:** copy operation was not finished successfully.
 - **No USB:** any USB is not connected.
 - **No File:** there is no file to copy in USB.



 The operation to copy from USB to TV can be executed by pressing **ENTER** key for 5 seconds.

 The Hotel TV product family does not support the **CLONE** function between a model that supports the satellite / T2 operation and a model that does not.

For fast instant cloning during installation!
Insert USB key with master settings from first TV and press Enter key for 5 seconds.

Plug & Play

Hotel Plug & Play is a function that automatically performs the Hotel mode selection, Country Setup, Clock Setup and Picture mode Setup once.

- Hotel Plug & Play is available only one time when power is first turned ON.
- After setting up first TV and Clone TV to USB
- Next TV only needs to exit Hotel Plug & Play, connect USB, then Clone USB to TV.

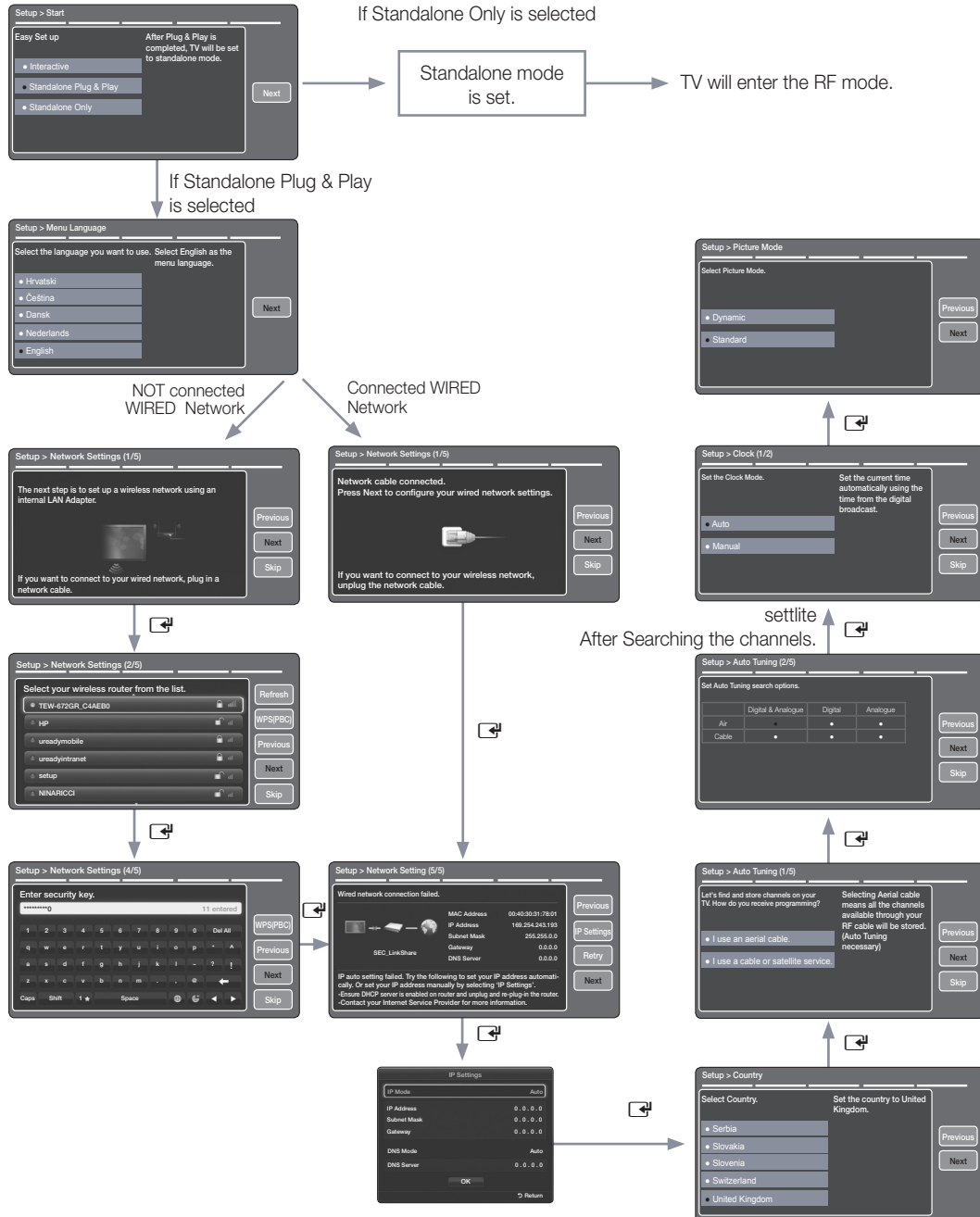

- Plug & Play OSD
 - Initial Highlight: Interactive
 - If Standalone Only button is selected, the Standalone hotel mode is set by default and “Standalone mode is set” OSD is displayed for 3 seconds.
 - TV enters into RF mode automatically after displaying “Standalone mode is set” OSD for 3 seconds.
 - When Interactive mode is selected, Interactive Setup Menu is displayed. Press power off button to exit from Interactive menu.
 - When Standalone Plug & Play mode is selected, “Select Menu Language” OSD is displayed.

- Select Menu Language OSD
 - When Standalone Plug & Play is selected from “Easy Set Up” OSD, “Select Menu Language” OSD is displayed.
 - Initial Highlight : English
 - Display time: OSD timeout and operation are the same as Samsung's consumer TV models.
 - If ENTER button is pressed, “Select Area” OSD is displayed.

- Select Country
 - Initial Highlight: United Kingdom.
 - The Country OSD is displayed and the area can be selected.

- Clock setting OSD
 - Display time: 30 seconds.
 - The Clock Set item OSD is displayed
 - If ENTER button is pressed after setting the clock or in Auto, Picture Mode OSD is displayed.

- Auto Search Mode OSD
 - If skip option is selected, it goes to Clock setting OSD.
 - If ENTER button is pressed, auto searching of channels is performed.
 - The OSD Display time, which is from the time that Auto Store is started to the time that Auto Sort is completed, is 30 seconds.

- Picture Mode OSD
 - Initial Highlight: Standard.
 - The Picture Mode OSD is displayed and the Dynamic or a Standard Picture mode can be selected.
 - After selecting the picture mode, it enters Standalone Setup Menu OSD, press power off to exit.

Multi Code Remocon

Multi Code Remocon is a special transmitter which is designed to control each TVs with one remote.

This function is useful where there is more than one TV in one location like hospital Set ID number will be displayed in source osd. It is possible to support up to 9 different remote key transmission for multi code.

Initial ID code which each TV has is "0".

- ID code could be set and reset in Analog TV mode or PC mode. (not available in TTX channel or DTV channel)
- ID code could be from 0 to 9.
- Press Blue Key for over 7 seconds and the digit key a user wants to set.
- Set ID OSD will be displayed in central position.
- The following words will be displayed. "Remote control code is set to x. If you want to change Remote control code. Enter the digit you want to change." (x is the digit number) This OSD will be kept displaying until exit key is input.



Remote control code is set to 0. If you want to change Remote control code, enter the digit you want to change.

- For example, TV and Remote will be set ID code #1 if user presses #1.
- The following words will be displayed. "Remote control code is changed to 1" Then TV can be controlled by only remote which has same ID code with TV's.
- If ID code does not match between remote and TV, the following words will be displayed. " TV ID x"(x is the TV's ID)
- To reset ID code, press Yellow key for over 3 seconds. ID code of both TV and Remote will be reset to "0". "Remote control code is set to 0." will be displayed.

CH Bank Editor (Smooovie TV Only)

Channel Bank Editor is a function to edit the channel with 3 different Bank Options. Depending on the Bank card, there are specific channels Hotel customer can enjoy.

Setting the CH Bank Editor under Stand-alone Mode

1. Enter the Hotel Standalone menu by "MUTE+1+1+9+Enter"
2. Please select SI vendor : "Smooovie"
3. You will be able to find new menu option "CH Bank Editor"
4. Enter the "CH Bank Editor"

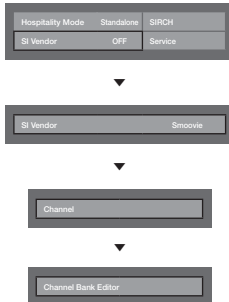

<Depending on model and region, some menu items may not exist>

5. Edit the channel bank like below example.
 - a. BANK1 (Free channel): Select the channel that will be used when remote doesn't have any card.
 - b. BANK2 (Family Card - Green): Select the channel that will be used when remote has the GREEN CARD.
 - c. BANK3 (Adult Card - Red): Select the channel that will be used when remote has the RED CARD.

Channel Bank Edit			
	Bank1 (4)	Bank2 (6)	Bank3 (36)
All	<input type="checkbox"/>	<input type="checkbox"/>	<input checked="" type="checkbox"/>
1 1futech	<input checked="" type="checkbox"/>	<input checked="" type="checkbox"/>	<input checked="" type="checkbox"/>
1 BBC 1	<input checked="" type="checkbox"/>	<input checked="" type="checkbox"/>	<input checked="" type="checkbox"/>
2 24ore.tv	<input type="checkbox"/>	<input checked="" type="checkbox"/>	<input checked="" type="checkbox"/>
2 C3	<input type="checkbox"/>	<input checked="" type="checkbox"/>	<input checked="" type="checkbox"/>
3 BBC World	<input type="checkbox"/>	<input checked="" type="checkbox"/>	<input checked="" type="checkbox"/>
3 C5	<input type="checkbox"/>	<input checked="" type="checkbox"/>	<input checked="" type="checkbox"/>
4 Coming Soon	<input type="checkbox"/>	<input type="checkbox"/>	<input checked="" type="checkbox"/>
4 S2	<input type="checkbox"/>	<input type="checkbox"/>	<input checked="" type="checkbox"/>

▼

References of using SMOOVIE Remote Controller

1. If you select SMOOVIE as SI vendor, you should use SMOOVIE Remote Controller.
2. With Numeric key of remote controller, user can select only Bank1 channel.
In this reason, if you want to change the channel using Green or Red Card, please use channel up/down keys.
3. At the Channel guide or the Channel list, user can see only Bank1 channel list.

Channel Editor

Channel Editor is a function to edit channel number and name.

- Use Channel Editor to sort the channels as user-desired channel numbers.

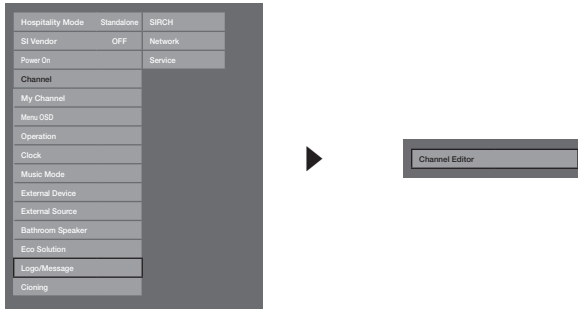

<Depending on model and region, some menu items may not exist>

Simple Steps for channel Editor under Stand-alone Mode

Step	Broad Outline
1	Operate 'Channel Auto Store' in Hotel Option Menu
2	Enter 'Channel Editor' in Hotel Option Menu
3	Compile a table related to the final channel lists you want to have
4	Rearrange channels with TOOLS Button based on the table you compiled
5	Press EXIT or RETURN Button to exit.

<For better comprehension, please refer to the following details>

Smovie On sequence

Step	Smovie TV used (Air/ Cable)			
	Mixed Channel Map On (Air and Cable both used)		Only Air or Cable used	
	If the tv starts with Hotel P&P	If P&P already done	If the tv starts with Hotel P&P	If P&P already done
1	Do the P&P except channel store	Enter Hotel menu	Do the P&P all (Air or Cable auto tune)	Enter Hotel menu
2	After P&P TV will show hotel menu	Setup Mixed Channel Map On	After P&P TV will show hotel menu	Select channel type - ATV or ADTV for Air - CATV or CDTV for cable
3	Setup Mixed Channel Map On	Make TV power off & on	Select channel type - ATV or ADTV for Air - CATV or CDTV for cable	Select smovie TV in Hotel menu
4	Make TV power off & on	Enter Hotel menu	Select smovie TV in Hotel menu	Select Channel Setup
5	Enter Hotel menu	Select smovie TV in Hotel menu	Select Channel Setup (can be skipped)	Select "Air" or "Cable" to auto tune
6	Select smovie TV in Hotel menu	Select Channel Setup	Select "Air" or "Cable" to auto tune (can be skipped)	setup CH Bank Editor
7	Select Channel Setup	Select "Air + Cable" to auto tune	Setup CH Bank Editor	After power off & on, user can use TV
8	Select "Air + Cable" to auto tune	Setup CH Bank Editor	After power off & on, user can use TV	
9	Setup CH Bank Editor	After power off & on, user can use TV		
10	After power off & on, user can use TV			

Step	Smovie TV used(Satellite)			
	Mixed Channel Map On (Satellite and Air or Cable both used)		Only Satellite used	
	If the tv starts with Hotel P&P	If P&P already done	If the tv starts with Hotel P&P	If P&P already done
1	Do the P&P except channel store	Enter Hotel menu	Do the P&P all (Air or Cable auto tune)	Enter Hotel menu
2	After P&P TV will show hotel menu	Setup Mixed Channel Map On	after P&P TV will show hotel menu	Select channel type - ATV or ADTV for Air - CATV or CDTV for cable
3	Setup Mixed Channel Map On	Make TV power off & on	Select channel type - ATV or ADTV for Air - CATV or CDTV for cable	Select smovie TV in Hotel menu
4	Make TV power off & on	Enter Hotel menu	Select smovie TV in Hotel menu	Select Channel Setup
5	Enter Hotel menu	Select smovie TV in Hotel menu	Select Channel Setup (can be skipped)	Select Satellite to auto tune
6	Select smovie TV in Hotel menu	Select Channel Setup	Select Satellite to auto tune (can be skipped)	Setup CH Bank Editor
7	Select Channel Setup	Select Satellite to auto tune	Setup CH Bank Editor	After power off & on, user can use TV
8	Select Satellite to auto tune	Setup CH Bank Editor	After power off & on, user can use TV	
9	Setup CH Bank Editor	After power off & on, user can use TV		
10	After power off & on, user can use TV			

Channel List

You can view channel information, **All**, **TV**, **Radio**, **Data/Other**, **Analogue** or **Favourites 1-5**.

When you press the **CH LIST** button on the remote control, **Channel List** screen will be displayed at once.

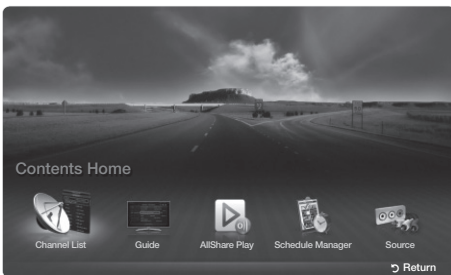

* The displayed image may differ depending on the model.

- **All**: Shows all currently available channels.
- **TV**: Shows all currently available TV channels.
- **Radio**: Shows all currently radio channels.
- **Data/Other**: Shows all currently available MHP or other channels.
- **Analogue**: Shows all currently available analogue channels.
- **Favourites 1-5**: Shows all favourite channels.

If you want to view favourite channels you added, press the **CH LIST** button and use **◀▶ (Ch. Mode)** button to move **Favourites 1-5**.

Using the control buttons with the **Channel List**.

- **Tools** (Tools): Displays the option menu.
- **◀▶ (Ch. Mode / Channel)**: Move to the **All**, **TV**, **Radio**, **Data/Other**, **Analogue** or **Favourites 1-5**.
 - When you select the **Programme View** in **Tools** menu, you can move to other channels using **◀▶ (Channel)** button.
- **Watch / Information** (Watch / Information): Watches the channel you selected. / Displays details of the selected programme.
- **◀▶ (Page)**: Move to next or previous page.

How to use Schedule Viewing in Channel List

(digital channels only)

When you set the **Schedule Viewing** in **Channel List**, you can only set the programme in **Programme View**.





1. Press the **CH LIST** button, then select a desired digital channel.
2. Press **TOOLS** button, and then select the **Programme View**. The programme list for that channel appears.
3. Press the **▲ / ▼** buttons to select the desired programme, then press the **ENTER** (Information) or **INFO** button.
4. Select **Schedule Viewing**, then press the **ENTER** button when done.

 If you want to cancel **Schedule Viewing**, follow steps 1 through 3. Select **Cancel schedule**.

Using Option Menu





Set each channel using the **Channel List** menu options (**Programme View, Edit Favourites, Lock/Unlock, Edit Channel Name, Edit Channel Number, Delete, Information, Sort, Edit Mode**).

Option menu items may differ depending on the channel status.

1. Select a channel and press the **TOOLS** button.
2. Select a function and change its settings.
 - **Programme View**: Displays the programme when digital channel is selected.
 - **Edit Favourites**: Set channels you watch frequently as favourites. Add or delete the selected channel in **Favourites 1-5**.
1. Select the **Edit Favourites**, then press the **ENTER** button.
2. Press the **ENTER** button to select **Favourites 1-5**, then press the **OK** button.
 -  One favourite channel can be added in several of favourites among **Favourites 1-5**.
 - **Lock/Unlock**: Lock a channel so that the channel cannot be selected and viewed.
 -  This function is available only when the **Channel Lock** is set to **On**.
 -  The PIN input screen appears. Enter your 4-digit PIN. Change the PIN using the **Change PIN** option.
 - **Edit Channel Name** (analogue channels only): Assign your own channel name.
 - **Edit Channel Number** (digital channels only): Edit the number by pressing the number buttons desired.
 -  Some area may not be able to support **Edit Channel Name** and **Edit Channel Number** function.
 - **Delete**: You can delete a channel to display the channels you want.
 - **Information**: Displays details of the selected programme.
 - **Sort**: Changes the list ordered by channel number or channel name.
 - **Edit Mode**: You can select desired channels and edit it.

Using Option Menu

Set each channel using the menu options (**Edit Favourites, Lock/Unlock, Delete, Deselect, Select All**).

1. Press the **TOOLS** button in **Channel List** screen, then select the **Edit Mode**. A check box appears to the left of the channel.
2. Press the **▲/▼** buttons to select the desired channel, then press the **ENTER** button. The (✓) mark indicates the channel you've selected.
 -  You can select more than one channel.
 -  Press the **ENTER** again to deselect the channel.
3. Press the **TOOLS** button, then select a function and change its settings.
 - **Edit Favourites**: Set the selected channels you watch frequently as favourites.
 -  The **Edit Favourites** screen has five groups (**Favourites 1, Favourites 2, etc.**). You can add a favourite channel to any one of the groups. Press the **▲/▼** buttons to select a group.
 - **Lock/Unlock**: Lock a channel so that the channel cannot be selected and viewed.
 -  This function is available only when the **Channel Lock** is set to **On**.
 -  The PIN input screen appears. Enter your 4-digit PIN. Change the PIN using the **Change PIN** option.
 - **Delete**: You can delete a channel to display the channels you want.
 - **Deselect**: Deselect the selected channels.
 - **Select All**: Select all the channels in the channel list.

My Channel

Determines the country and genre for the channels provided by the hotel, and if the user selects a country and genre, shows the corresponding channels.

- You must select the country first, or you can NOT set a genre.
- If you select the genre that NOT added any channels, Channel list display all of channels.
- My Channel works in Standalone mode only.
- SI Vendor in Standalone mode: This des not work if Smoovie is selected.
- This is in the Hotel Options in Hotel Menu > Service Mode and can be turned on or off.
- The option only works when it is set to On.

Channel Composition [Genre Mode]

Standard	Category	Ch. Mode	Antenna Mode Activation		Description
			Air/Cable	Satellite	
Hotel	Genre	All (Default)	<input type="radio"/>	<input type="radio"/>	Provide genre channel mode by each country that master has managed in factory mode.
		News	<input type="radio"/>	<input type="radio"/>	
		Radio	<input type="radio"/>	<input type="radio"/>	
		Entertainment	<input type="radio"/>	<input type="radio"/>	
		Sport	<input type="radio"/>	<input type="radio"/>	
		Hotel	<input type="radio"/>	<input type="radio"/>	

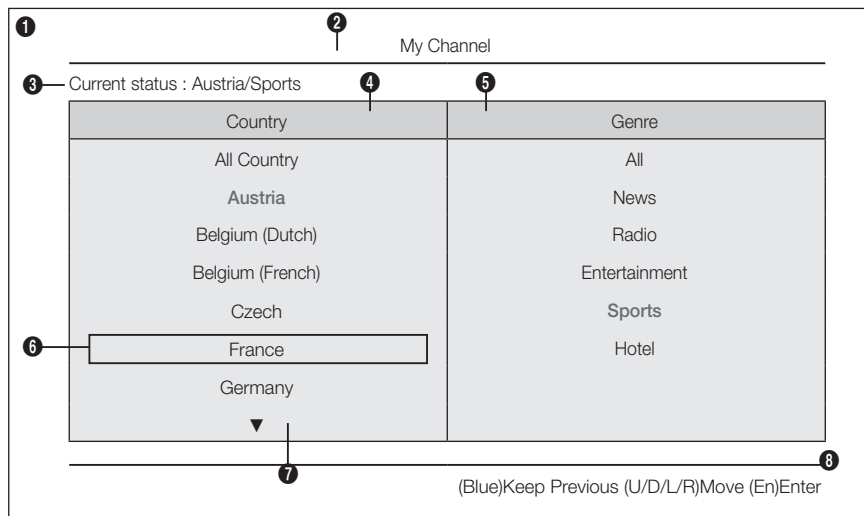

* For the number of items to be displayed in the list, refer to the design document.

Key Guide

Button	Action	Nav. Help
BLUE	Returns to the screen. (Genre setup: Last Country & Genre)	Keep Previous
ENTER	Selects an item.	Enter
Ch. Up/Down	Move the highlight by page.	(No Guide)
UP/DOWN	Navigates the each country, genre list. (in a circular manner.)	Move
RIGHT	Selects the highlighted item, and then move the highlight to Genre section.	
RETURN	Returns to the screen. (Genre setup: Last Country & Genre)	(No Guide)
EXIT	Returns to the screen. (Genre setup: Last Country & Genre)	(No Guide)

Notes

- This section describes the layout of Front UI that appears when TV is turned on. (Factory Mode > Genre Mode: Enable)
- The genre is sub-list of each country.
- The broadcast screen that was being displayed the last memorial channel.
 - If user want to keep previous country & genre channel map, presses 'BLUE', RETURN, EXIT remote-control key to close the Front UI.

Etc.

- Default Highlight : Last Memory items (Country, Genre)
- Timeout (60 sec)

Elements

No	Name	Description
1	Background Screen	<ul style="list-style-type: none">• Displays the last memorial channel that shows when TV is turned on.
2	Function Title	<ul style="list-style-type: none">• This is name of the function.
3	Current Status	<ul style="list-style-type: none">• Display current settings the Country/Genre.
4	Country Items	<ul style="list-style-type: none">• The item for the country list is displayed.• Displays the last selected country.
5	Genre Items	<ul style="list-style-type: none">• The item for the genre list is displayed.• Displays available genre items by each country that master managed in factory mode. (always provide 'All' item)• Displays the last selected genre.
6	Highlight	<ul style="list-style-type: none">• If the item title is too long to be displayed within the area, Auto Text Sliding works.
7	Indicator	<ul style="list-style-type: none">• This is displayed when there is a previous or next page.
8	Nav. Help	<ul style="list-style-type: none">• The key guide is right-aligned.

Highlight Interaction [Country Items]

- This page is only for interaction. Each screen may not be exactly identical to actual one.

Notes

- User can navigate the list items in each country & genre list by pressing the up or down remote control keys.
- Circular navigation is supported.

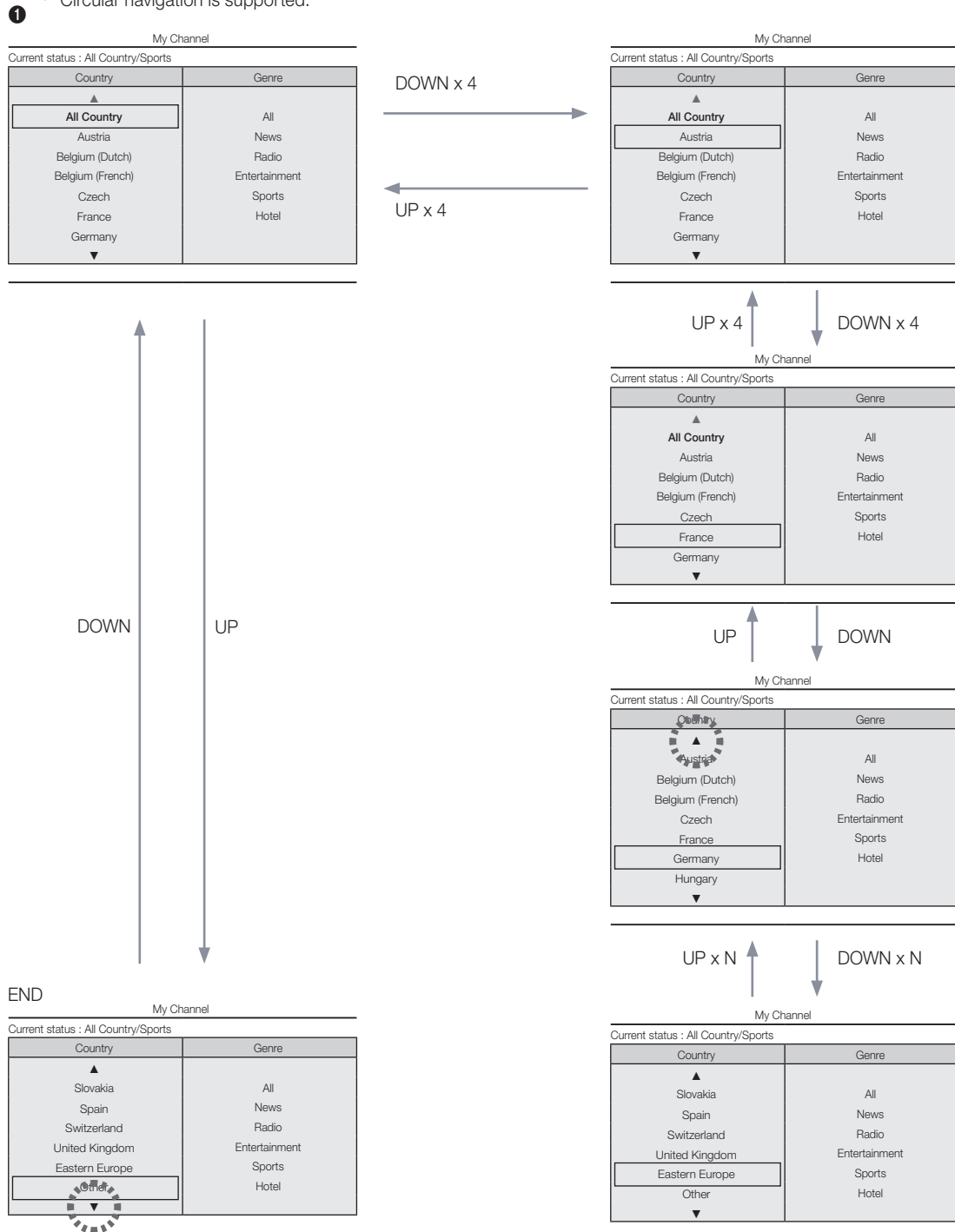

Highlight Interaction [Default Genre]

- This page is only for interaction. Each screen may not be exactly identical to actual one.

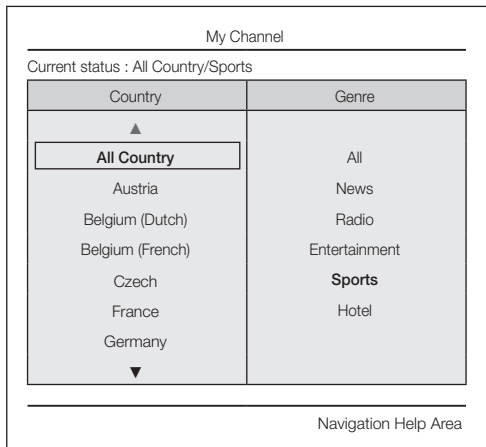

- The current selection of the country is high-lighted.

ENTER / RIGHT

LEFT

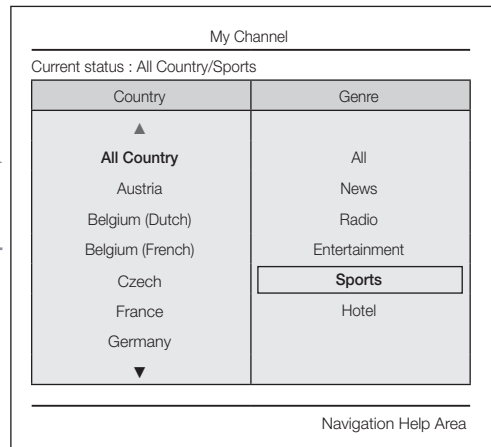

- Default High-light: The current selection of the genre.

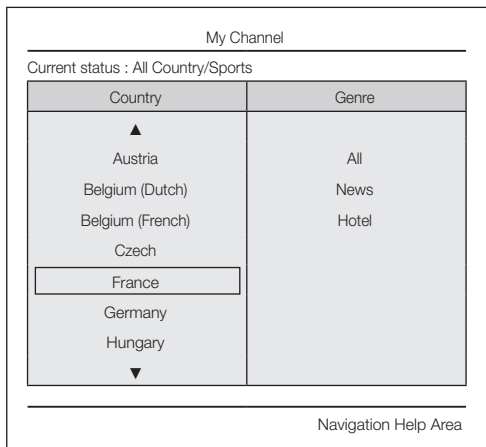

- The other item of the country is high-lighted. (ex. France)

ENTER / RIGHT

LEFT

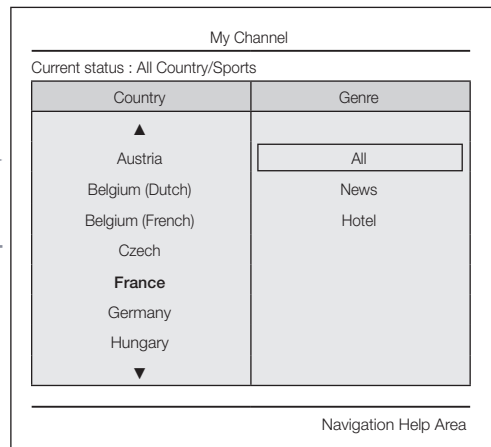

- Default Highlight : All

Mode Change Interaction 1 (1/2)

- This page is only for interaction. Each screen may not be exactly identical to actual one.

1

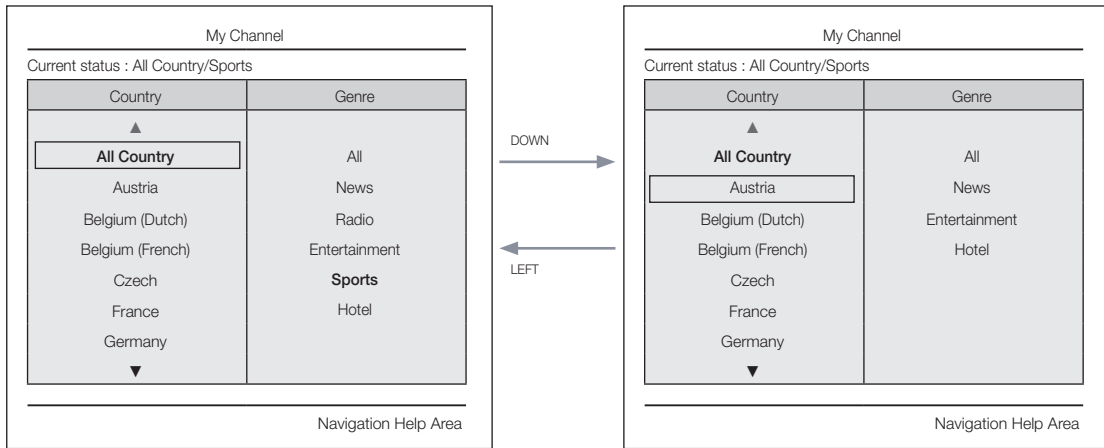

- Current Genre Mode : All Country / Sports

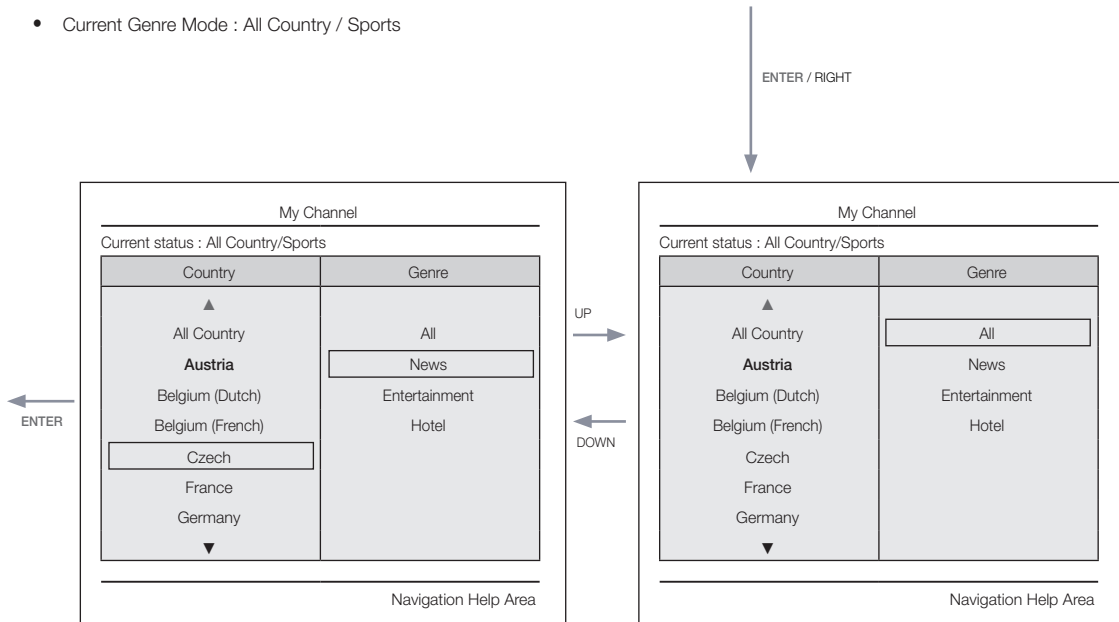

- If the country is selected, highlight move to genre menu automatically.

6

Mode Change Interaction 1 (2/2)

- This page is only for interaction. Each screen may not be exactly identical to actual one.

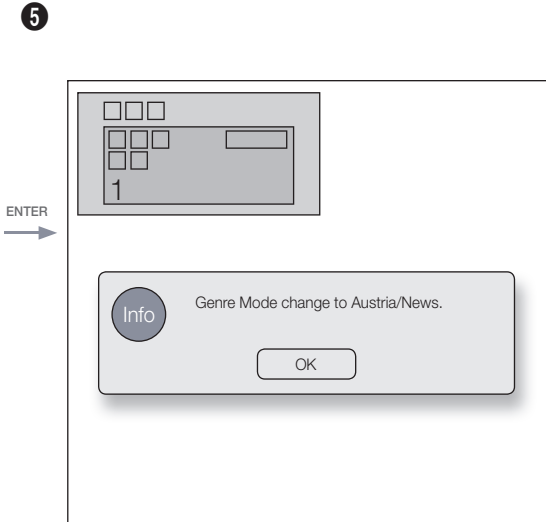

- The genre mode change complete message is displayed.
- Timeout(5 sec.)

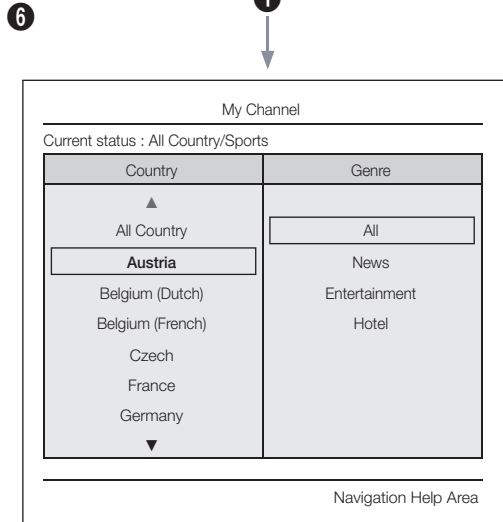

- If the left key is pressed from the genre to country menu, highlights an existing selected country item.

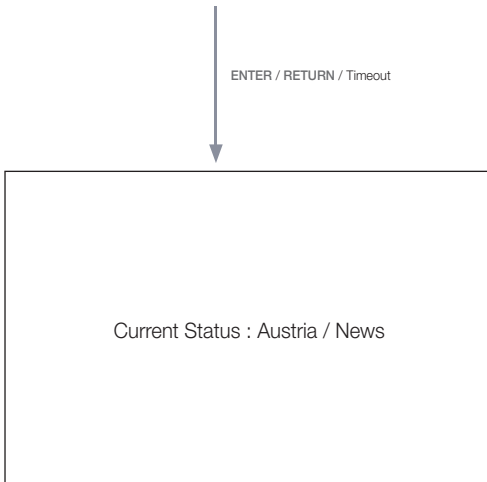

Mode Change Interaction 2 (1/2)

- This page is only for interaction. Each screen may not be exactly identical to actual one.

1

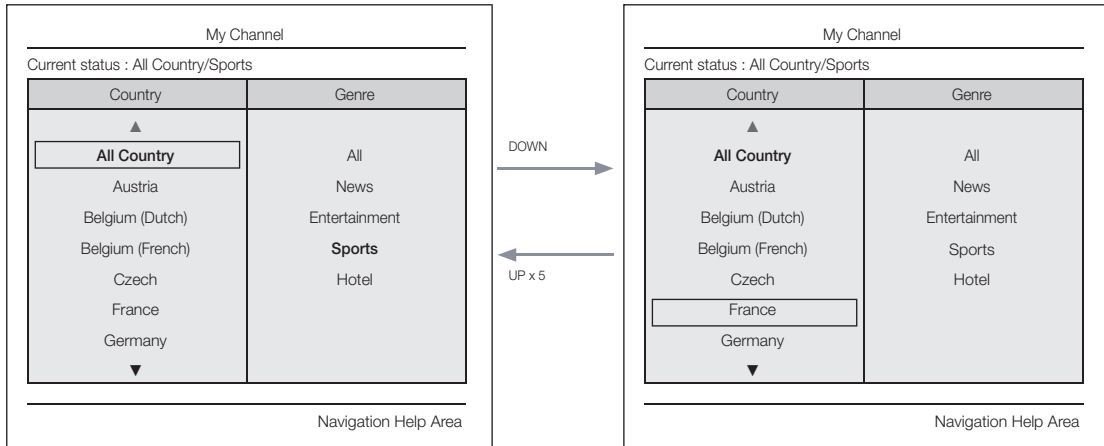

- Current Genre Mode : All Country / Sports

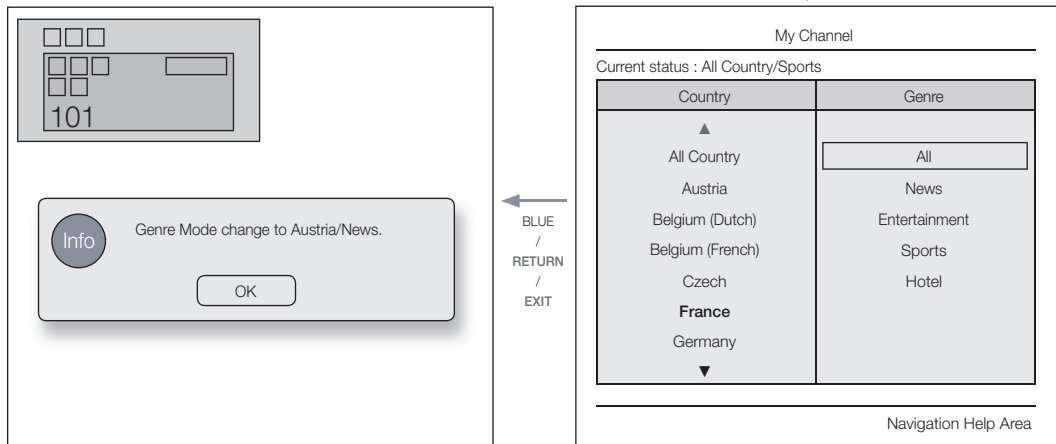

- If the country is selected, highlight move to genre menu automatically.

5



- Current Genre Mode : All Country / Sports

Power On Scenario [Last Memory]

- This page is only for interaction. Each screen may not be exactly identical to actual one.

1

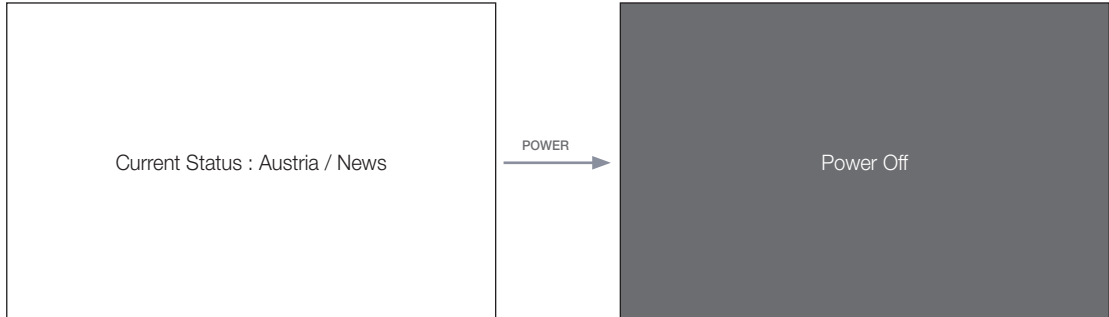

- Current Genre Mode : Austria / News

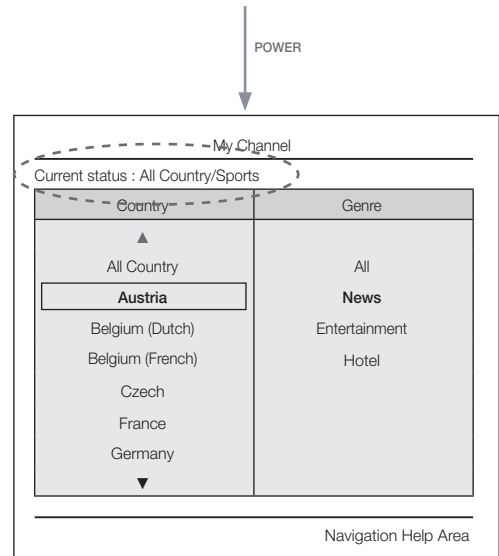

- Current Genre Mode : Austria / News

Genre Editor (This configures the genres of each of the hotel TV channels.)

- This can be used through the Hotel Menu (Factory).
- Supported genres include News, Radio, Entertainment, Sports and Hotel.
- More than one genre can be selected for each channel at the same time.

Country Editor (Channel Editor): This is the editor that configures the country for each of the hotel TV channels.

- Supported countries (20 countries): Austria, Belgium, China, Denmark, Finland, France, Germany, Greece, Italy, Japan, Netherlands, Norway, Portugal, Russia, Korea, Spain, Sweden, Turkey, USA
- If more than one channel is set to a country, the country is registered as a category and users can view the channels by country.
- More than one country can be set to a channel. If the user selects a category, only the channels corresponding to the country are displayed in the channel list.
- If any channel for which the country is set is selected from the channel list, the Edit Countries item is added to the Tools. Otherwise, the Add to Countries item is added to the Tools.
- * If the corresponding function is executed, a country for the selected channel can be set or canceled.
- Front UI
- Provides the screen where the user can select a country or genre when the user turns the power on.

Left Frame Layout

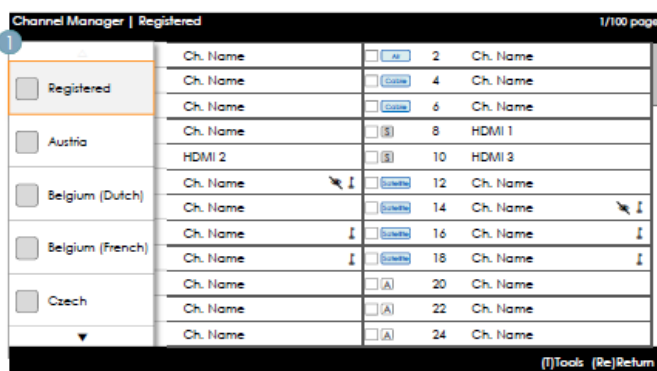

Key Guide

Button	Action	Nav. Help
ENTER	Selects or enters the corresponding Channel Browser area.	(No Guide)
RETURN	Selects or enters the corresponding Channel Browser area.	Return
UP/DOWN	Moves the highlight up or down.	(No Guide)
RIGHT	Moves the highlight to the Channel Browser area.	(No Guide)
INFO	Shows the Category Info.	(No Guide)
TOOLS	Shows the utility function menus.	Tools
EXIT	Cancels and returns to the previous step (Factory Mode).	(No Guide)

Notes

- This is a component of the Left Frame (Country Categories).

Etc.

- Default Highlight: 'The currently selected country'

Elements

No	Name	Description
1		<ul style="list-style-type: none"> When the user enters this screen, the currently selected default item is highlighted. The Country Icon + Category Name are provided. (If the highlight is in the Main Frame, only the icon is displayed.) Moving the highlight <ul style="list-style-type: none"> Pressing the up or down button moves the highlight. If the items cannot be displayed on one page, up and down indicators are provided. Once the highlight is moved to a category, the channel list corresponding to the corresponding category is loaded to the Main Frame.

Left Frame [Country Categories]

Standard	Category	Ch. Mode	Antenna Mode Activation		Description
			Air/Cable	Satellite	
Hotel	Original Tuned	Registered	O	O	<ul style="list-style-type: none"> Lists all the channels registered by the Auto Tune operation.
	Country	All Country	O	O	<ul style="list-style-type: none"> Provides the list of channels and sources specified in the Registered Channels list. All Country is the sum of all channels registered to each country. (This is only provided to end users.)
		Country 1	O	O	
		Country 2	O	O	
.	O	O			

Tools [Registered/Countries Categories]

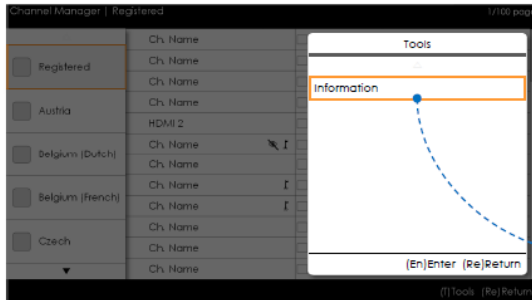

- Channel Manager > Channel Category > Tools > Info

Registered	: 3210
Austria	: 400
Belgium(Dutch)	: 700
Belgium(French)	: 0
Czech	: 60
...	: 70
...	: 80
▼	
Ok	

- The items are displayed without 'Channel'.
- If the Registered/Country item in the Left Frame is highlighted, you can enable the corresponding window by pressing the 'INFO' remote control key.
- All countries are displayed.
- You can navigate country items by pressing the up or down key. (Indicators are provided.)

 Notes

- This is a definition of the Tools menu in the Left Frame Category.
- Only the Info item for each Register/Country is provided.

Elements

Category	Tools menu	Descriptions
Registered, Country	Information	Registered Channels. The number of channels of each country.

- The items are displayed without 'Channel'.

Error Cases

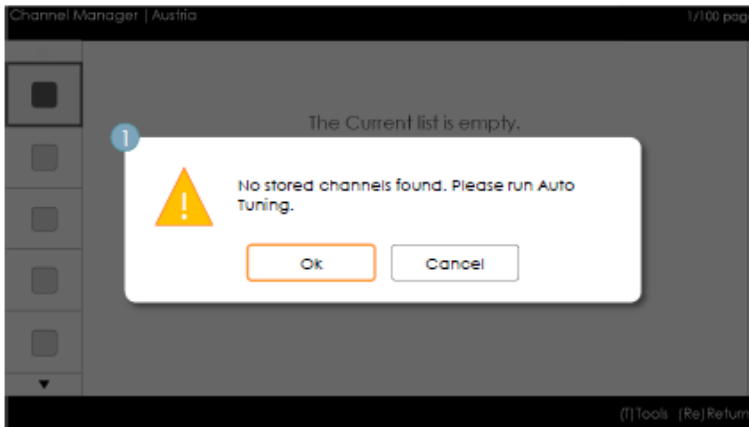

 Notes

- This is the message for when there are no saved channels in the Registered Channels list.

Elements

No	Name	Description
1	Message	<ul style="list-style-type: none"> • When entering the browser, if the Registered channels item is empty, a popup message is displayed which enables users to switch to the Auto Store (Program) menu. • When both the time and the channel are not configured, and a user enters the Channel Manager, a message that allows the user to switch to the Auto Tuning (Auto Program) operation is displayed in the same way as above.

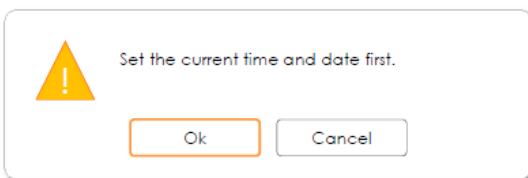

- This is the message when the time is not configured.
 - If the time is not configured, the message is displayed in Factory Mode before entering the Channel Manager.

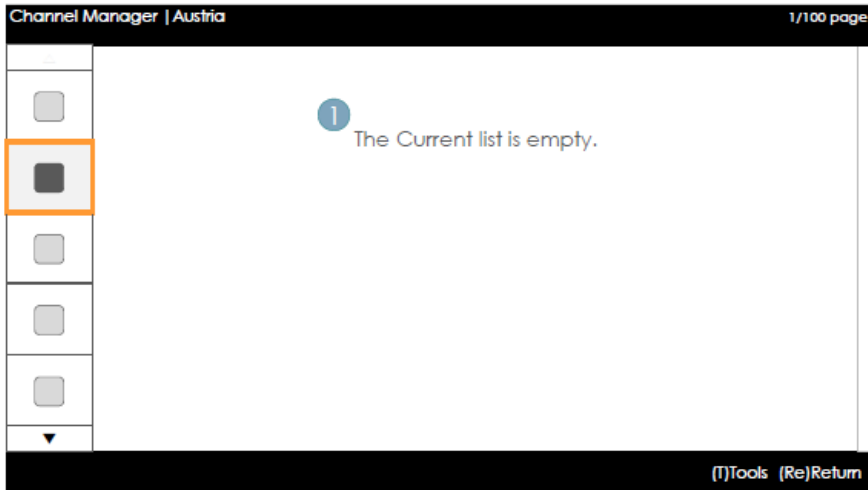

Notes

- This is the component for when there are no channels registered to the country category.

Elements

No	Description	Description
		<ul style="list-style-type: none"> • The message is displayed when the currently selected country does not contain any items.

Main Frame [Channel Browser]

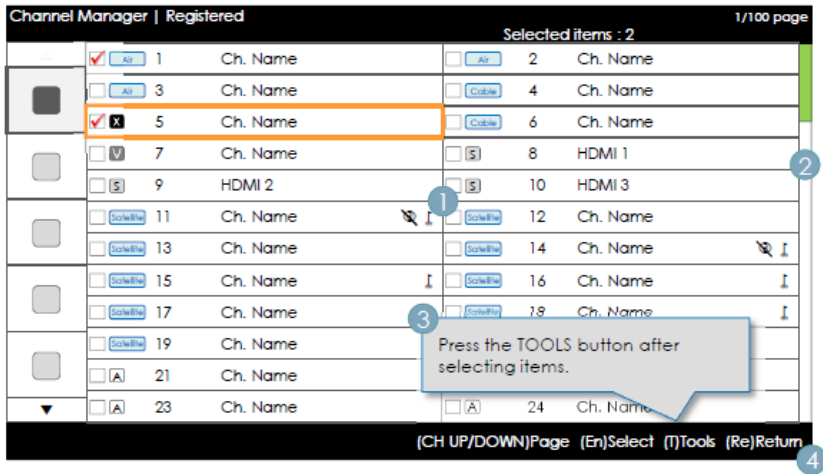

Key Guide

Button	Action	Nav. Help
CH UP/DOWN	Moves the page.	Page
ENTER	Selects or enters the corresponding Channel Browser area.	Select
RETURN	Returns to the previous step (Factory Mode).	Return
UP/DOWN	Moves the highlight up or down.	(No Guide)
RIGHT	Moves the highlight to the Channel Browser area.	(No Guide)
INFO	Shows the Category Info.	(No Guide)
TOOLS	Shows the utility function menus.	Tools
EXIT	Cancels and returns to the previous step (Factory Mode).	(No Guide)

Notes

- This is a component of the Main Frame (Channel Browser).
- The initial highlight is on the channel before entering Factory Mode or the external input.

Elements









No	Name	Description
1	Main Frame	<ul style="list-style-type: none"> • Shows the channel or the source list of the currently selected category.
2	Scroll Bar	<ul style="list-style-type: none"> • Shows the position of the current page amongst the total amount of pages.
3	Navigation Help Area	<ul style="list-style-type: none"> • This is displayed whenever a user enters the Channel Manager. (If a user exits and then reenters the Channel Manager, it is displayed again.) • This disappears when the timeout (5 sec.) is reached or a user presses a key.
4	Navigation Help Area	<ul style="list-style-type: none"> • The currently configured country information and the RED buttons are left-aligned. (They are displayed and navigated by group graphically.) The key guide is right-aligned.

Channel Common Elements [+ Icon-method]

Channel list representation rules

Standard	Item	Construction
ATSC	Digital channels	<ul style="list-style-type: none"> Check Box + Status Icon + Digital Channel Number + Channel Name <ul style="list-style-type: none"> Channel number representation format: ###-### (The channel number is represented by '-'.)
	Analog channels	<ul style="list-style-type: none"> Check Box + Analog Icon + Analog Channel Number + Channel Name <ul style="list-style-type: none"> Channel number representation format: ### ('-' is not used to represent analog channel numbers.)
DVB (CHEM)	Digital channels	<ul style="list-style-type: none"> Check Box + Status Icon + Digital Channel Number + Channel Name <ul style="list-style-type: none"> Channel number representation format: ### (For the maximum length of the channel number representation, follow the regional specifications.)
	Analog channels	<ul style="list-style-type: none"> Check Box + Analog Icon + Analog Channel Number + Channel Name <ul style="list-style-type: none"> Channel number representation format: ### (For the maximum length of the channel number representation, follow the regional specifications.)

Channel list icon representation rules

Item		Example		Priority
Dynamic SI Icon	Channels deleted by Dynamic SI	<input type="checkbox"/>  NNNNNNNN CH. NAME	<ul style="list-style-type: none"> Channels that have been deleted by the Dynamic SI but not by the user. 	1
	Channels added by Dynamic SI	<input type="checkbox"/>  NNNNNNNN CH. NAME	<ul style="list-style-type: none"> Channels that have been added by the Dynamic SI but not by the user. 	2
Analog Channel Icon		<input type="checkbox"/>  NNNNNNNN CH. NAME (The edited channel name.)	<ul style="list-style-type: none"> The analog channel icon is displayed. 	3
Source Channel Icon		<input type="checkbox"/>  NNNNNNNN CH. NAME	<ul style="list-style-type: none"> A channel that is an input source. 	4
Antenna Icon	Air	<input type="checkbox"/>  NNNNNNNN CH. NAME	<ul style="list-style-type: none"> Represents the live channels from the antennas. The Air, Cable or Satellite antenna icons are displayed at the lowest priority. 	5
	Cable	<input type="checkbox"/>  NNNNNNNN CH. NAME		
	Satellite	<input type="checkbox"/>  NNNNNNNN CH. NAME		
Scrambled Channel Icon		NNNNNNNN CH. NAME 	<ul style="list-style-type: none"> The scrambled channel icon. (This appears for the Satellite antenna.) 	-
Video Mute		NNNNNNNN CH. NAME 	<ul style="list-style-type: none"> A screen-muted channel. (Audio and channel information is provided.) 	-

Add to Countries / Edit Countries (1/2)

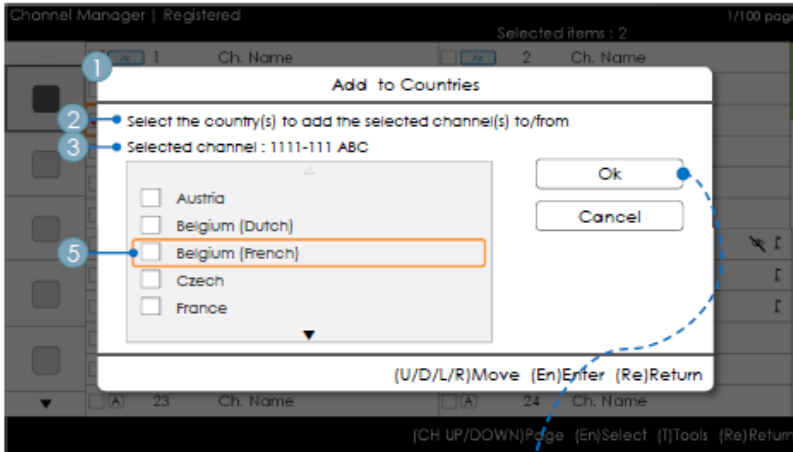

- Channel Manager > Browser > Tools > Add to Countries

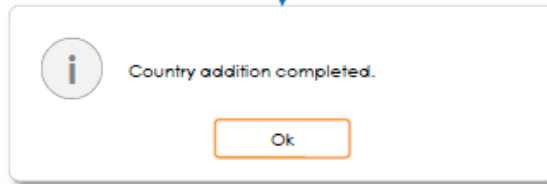

Key Guide

Button	Action	Nav. Help
ENTER	Selects the highlighted item.	Enter
RETURN	Cancels and returns to the previous screen (Tools).	Return
UP/DOWN	Moves the highlight over country items.	Move
LEFT/RIGHT	Moves the highlight.	Move
INFO	N/R	N/R
TOOLS	Closes the current window and displays the 'Tools' menu.	(No Guide)
EXIT	Cancels and returns to the previous step (Factory Mode).	(No Guide)

Note.

- This is the definition of Add to Countries.
- The highlighted channel or more than one selected channel is added to the Country category.

Etc.

- Timeout (60 sec)

Elements

No	Name	Description
1	Add to Countries Window	<ul style="list-style-type: none"> • If there are no channels that have been registered to the country list in the selected channels, "Add to Countries" is displayed as the title. • A check box is displayed depending on whether the country that was selected when entering the screen is registered or not.
2	Guide	
3	Selection Info	<ul style="list-style-type: none"> • The number of the selected channel or the channel name. - The channel name is displayed when one channel has been selected: Selected channel: NNNN-NNN ABC - The number of selected channels is displayed when more than one channel has been selected: Selected Channels : N
4	Complete Message	<ul style="list-style-type: none"> • The message is displayed after the completion of the operation. (This message is always displayed if the OK button is selected.)
5	Selection Mark	<ul style="list-style-type: none"> • How to identify the meaning of multiple channel selection marks <input checked="" type="checkbox"/> • When all of the items have been registered. <input type="checkbox"/> • When only part of the items have been registered. <input type="checkbox"/> • When none of the items have been registered.

Add to Countries / Edit Countries (2/2)

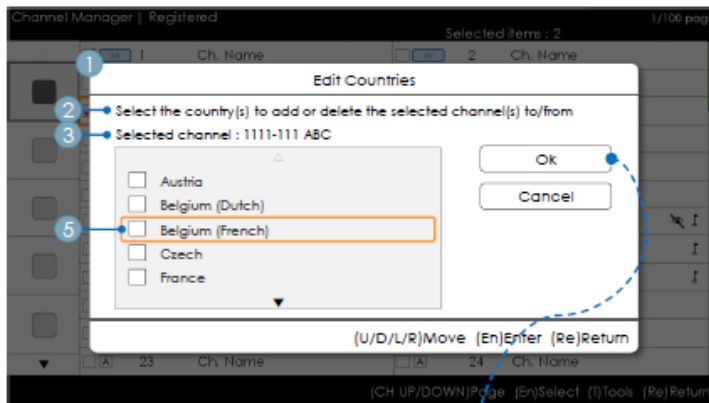

- Channel Manager > Browser > Tools > Add to Countries

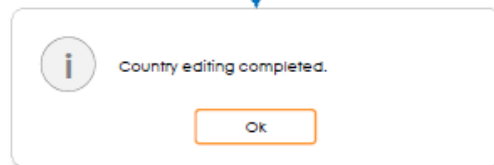

Key Guide

Button	Action	Nav. Help
ENTER	Selects the highlighted item.	Enter
RETURN	Cancels and returns to the previous screen (Tools).	Return
UP/DOWN	Moves the highlight over country items.	Move
LEFT/RIGHT	Moves the highlight.	Move
INFO	N/R	N/R
TOOLS	Closes the current window and displays the 'Tools' menu.	(No Guide)
EXIT	Cancels and returns to the previous step (Factory Mode).	(No Guide)

Notes

- This is the definition for Edit Countries.
- The highlighted channel item or more than one selected channel item is added or deleted from the Country category.

Etc.

- Timeout (60 sec)

Elements

No	Name	Description
1	Add to Countries	<ul style="list-style-type: none"> • If there is a registered channel among the selected channels, Edit Countries is displayed as the title. • A check box is displayed depending on whether the selected country is registered or not.
2	Guide	
3	Complete Message	<ul style="list-style-type: none"> • The message is displayed after the completion of the operation. (This message is always displayed if the OK button is selected.)

Edit Channel Number [Swap Type]

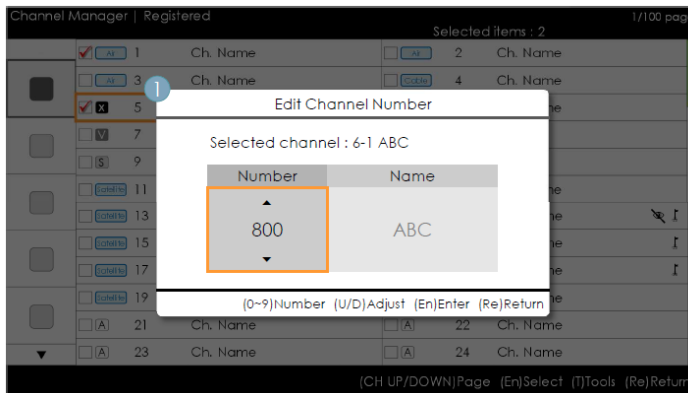

- Channel Manager > Browser > Tools > Edit Channel Number

Key Guide

Button	Action	Nav. Help
ENTER	Applies the changes and closes the window.	Enter
RETURN	Cancels and returns to the previous screen (Tools).	Return
U/D	Changes the channel number of the selected channel.	Adjust
0~9	Enters a digit.	Number
INFO	N/R	N/R
TOOLS	Closes the current window and displays the 'Tools' menu.	(No Guide)
EXIT	Cancels and returns to the previous step (Factory Mode).	(No Guide)

Notes

- This is the definition of the function that changes the channel number. (Swap Type)
- Channel numbers can be changed in all the channel lists and changes are applied to all the channels.
- If the new channel number has not been allocated to another channel, the channel number is updated to the new channel number and the list is sorted again in ascending order of channel number.
- If the new channel number has already been allocated to another channel, follow the Hotel specifications.

Etc.

- Vertical circulation is supported.

Elements

No	Name	Description
1	Edit Channel Number Window	<ul style="list-style-type: none"> Both the numeric keys and the Up/Down keys are supported. <ul style="list-style-type: none"> Selected Channel: Shows the currently selected channel name. Number: Shows the new channel number. (The currently allocated channel name is also displayed.) Name: Shows the currently allocated channel name. (If there are no channels, it is displayed as "(Empty)".) : If there is a channel but it does not have a name, the name is represented as "----".
2	Warning Message	<ul style="list-style-type: none"> If an already allocated channel is selected <ul style="list-style-type: none"> If the new channel number has already been allocated to another channel, the confirmation message pops up. (Refer to the figure below.) If the user wants to change the channel number to one that has already been allocated to another channel, the channel numbers are swapped and saved.

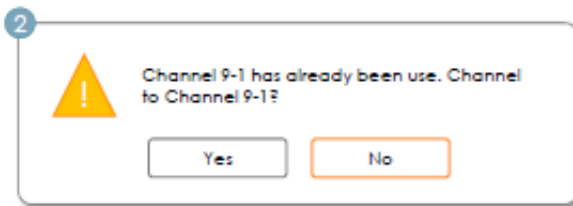

Edit the Channel Number [External Input] (3/3)

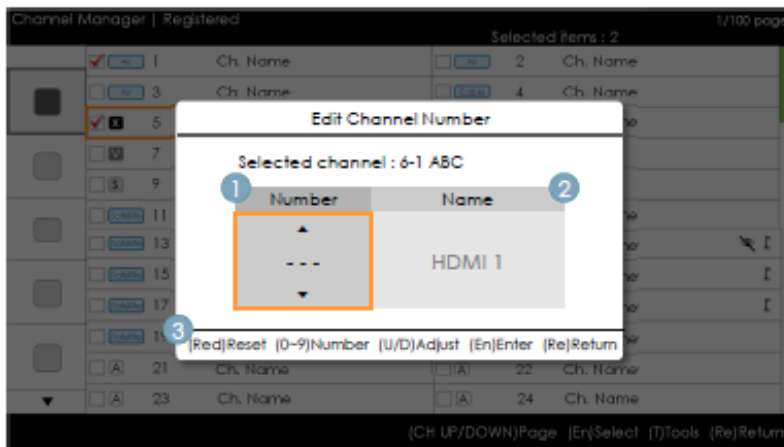

- Channel Manager > Browser > Tools > Edit Channel Number

Key Guide

Button	Action	Nav. Help
RED	If a user presses the button, the channel number is initialized.	Reset
ENTER	Applies the changes and closes the window.	Enter
RETURN	Cancel or returns to the previous screen (Tools).	Return
U/D	Changes the channel number of the selected channel.	Adjust
0~9T	Enters a digit.	Number
INFO	N/R	N/R
TOOLS	Closes the current window and displays the 'Tools' menu.	(No Guide)
EXIT	Cancel and returns to the previous step (Factory Mode).	(No Guide)

Notes

- This function allocates an external input source to a channel number. (The changes are applied to all the channels.)
- If the new channel number has already been allocated to another channel, follow the Hotel specifications.

Etc.

- Default Highlight: Channel number area.
- Vertical circulation is supported.
- Timeout (60 sec)

Elements

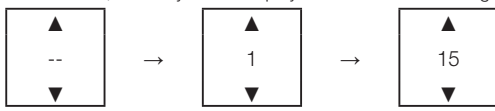
No	Name	Description
1	Channel Number Area	<ul style="list-style-type: none"> • The channel number area. <ul style="list-style-type: none"> - Both the numeric keys and the Up/Down keys are supported. - If no value is allocated, as many '-' are displayed as the number of digits. 
2	Source Name	<ul style="list-style-type: none"> • External input name <ul style="list-style-type: none"> - Items that cannot be configured are disabled.
3	Nav. Help Area	<ul style="list-style-type: none"> • If a user presses the red button, the channel number is initialized.

Edit Channel Name

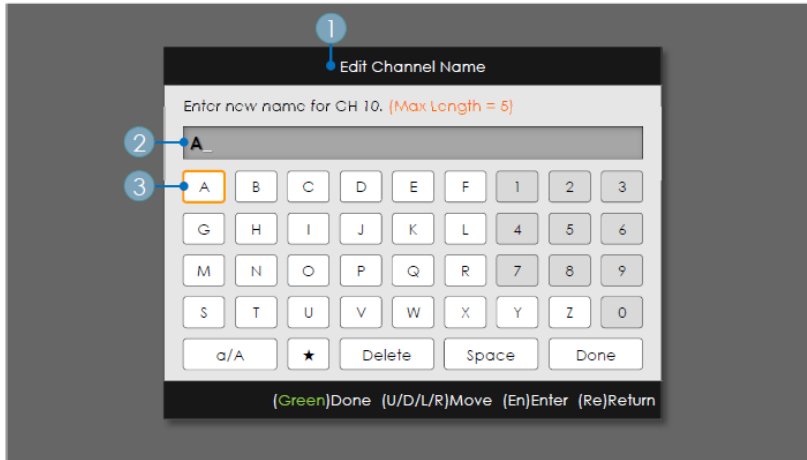

- Channel Manager > Browser > Tools > Edit Channel Name

Key Guide

Button	Action	Nav. Help
GREEN	Saves the changes and returns to the Channel Manager.	Done
ENTER	Saves the channel name and moves the cursor to the next field.	Enter
RETURN	Cancels and returns to the previous screen (Tools).	Return
U/D/L/R	Navigates on the keyboard.	Move
0~9	Enters a digit.	(No Guide)
INFO	N/R	N/R
TOOLS	Closes the current window and displays the 'Tools' menu.	(No Guide)
EXIT	Cancels and returns to the previous step (Factory Mode).	(No Guide)

Notes

- This is the definition of the keypad that is used for the Edit Channel Name function.

Etc.

- Timeout (60 sec)

Elements

No	Name	Description
1	Channel Name Edit Window	
2	Channel Name	<ul style="list-style-type: none"> • The cursor and the character that are currently being entered are in the color of the highlight. • When the maximum number of characters is reached, the cursor is not displayed.
3	Keyboard	<ul style="list-style-type: none"> • For a detailed scenario, refer to the keypad design document.

Tools [Edit Mode]

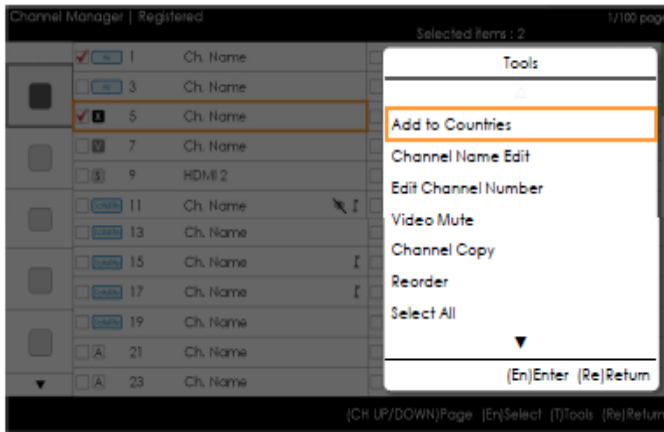

Edit Mode	
Content Highlight (when the number of the checked item is 0 or 1)	When there is more than one checked item.
Add to Countries Edit Countries (when an already-registered item is checked.) Channel Name Edit Edit Channel Number Video Mute Channel Copy (Astra HD +) Reorder (Satellite) Select All Deselect All (this is only displayed when 1 or more items are selected) Delete	Add to Countries Edit Countries (when an already-registered item is checked.) Video Mute Reorder (Satellite) Select All Deselect All Delete

Notes

- This is the definition of the Tools menu.
- The position of the popup menu: The Tools menu for an item in the left column of the Channel List → This is displayed on the right. The Tools menu for an item in the right column of the Channel List → This is displayed on the left.
- If a user presses the Tools button when the highlighted item is not selected, the item is automatically marked as selected.
- For the detailed specifications of each function, refer to the NEO Channel Manager.

CH Banner [when a channel number is allocated to an external input]

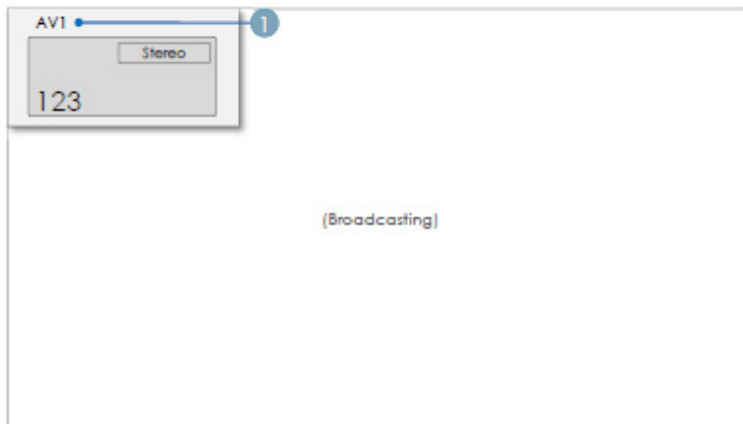

Notes

- The TV channel banner specifications are applied.
- When there is an unsupported item or there is no corresponding information, the item values are not displayed.
- The channel name is represented as the 'external input name'.

Elements

No	Name	Description
1	External Input Name	

The Channel List provides some functions of the GenreTV.

- Country Mode
- Changes the genre mode.

Mixed Channel Map

Mixed Channel Map is a function to mix Air, Cable and Setellite channels.

[Except for Aus, Singapore, NZ models]

- **Mixed channel Map should be ON in order to mix Air, Cable and Setellite channels.**
- **Use Channel Editor to sort the channels after turning on 'Mixed channel Map' in Hotel Option Menu.**

Sound Bar

- **Samsung Sound-Bar & Hospitality TV in 2012**

- Samsung Sound-Bar & hospitality TV support HDMI 1.4, so you can listen to TV's sound on Sound-Bar by using single HDMI cable.
- Supporting model.
 - Sound-Bar : HW-E350/E450/E550

- **The operation of "Hotel mode" in Sound Bar**

- The following items of TV's hotel option menus should be set in advance.
 - Hotel option → Power On → Power ON Volume = "Enable" / Power ON Vol / Max Vol
 - Hotel option → External Device → Sound Bar Out = "On"
- Connect an HDMI cable from the HDMI OUT port of Sound-BAR to the HDMI2 port of hospitality TV.
- After being connected to the 2012 hospitality TV via HDMI Cable, while TV turns on, Sound-Bar automatically detects TV and then, will be converted to "hotel mode" by itself.
- The change with power-on volume & max volume on TV is applied to the connected sound-bar since TV boots twice.

- **Features of "Hotel MODE" in Sound-BAR**

- Synchronized power on/off with TV.
- HDMI_CEC enabled.
- Accessible "HDMI OUT" port only. (Other inputs are disabled)
- Synchronized "power-on"&"max" volume with TV's one. (Sound-Bar's volume is set as the half of TV's one)
- Adjustable "power-on"&"max" volume acquired from TV's hotel option menu. (Sound-Bar volume=TV volume/2)
Ex.) If the volume settings in TV are "power-on volume=20 and max volume=90", Sound bar will work as power-on volume=10, max volume=45.

*This function may differ depending on the model.

SIRCH

• Introduction

SIRCH (Samsung Interactive Remote Control for Hospitality) is a professional interactive remote controller for DTV that lets you deliver TV firmware updates, cloning data, and channel mapping changes to several hundred hospitality TVs simultaneously. Mounted at the broadcast head-end system in hotels, motels, resorts, hospitals, and apartment buildings, it delivers modulated RF control signals to hospitality sets in each guest room through coax cable.

SIRCH includes PC embedded systems and cable RF modulators which have DVB-C (Europe) and OpenCable (North America) RF output. It also has a 40GB Solid State hard drive, and a 100/1000 Base-T Ethernet port which lets you load TV firmware updates.

 SIRCH is sold separately.

• System Block Diagram (eg. Headend System in Hotel)

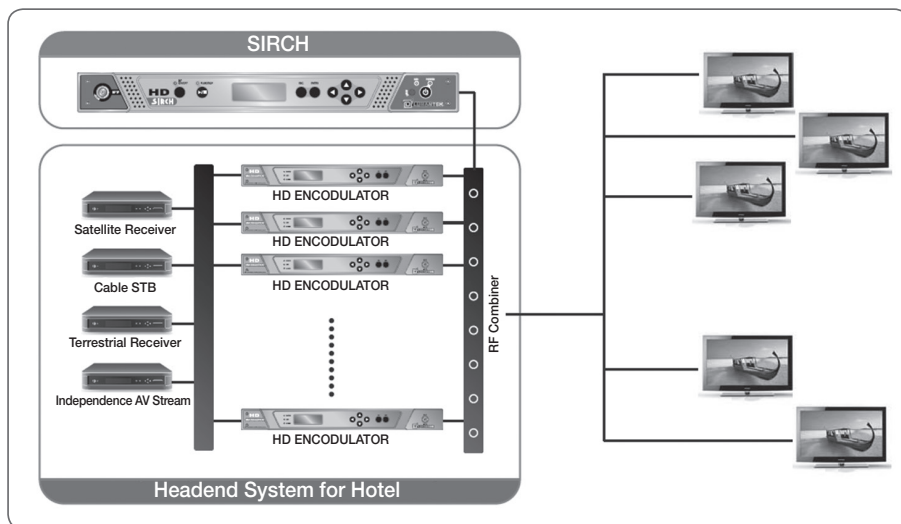

• Features

- SIRCH Windows Application SW
- 19 inch Rack Unit type, PC embedded Modulator : OpenCable.
- Remote Upgrade (TV Software, Cloning Data, Channel Map)
- Operation can be controlled by key button, extra key board, monitor, and mouse.
- Low Phase noise, High MER, 50~870MHz, +7 ~ -30dBm RF output.

• Cautions

- SIRCH can operate only in TV RF mode. (OpenCable QAM Modulation).
- You can install SIRCH only on TVs in the stand-alone mode. (Power On Source should be TV).
- SIRCH operates only when the SIRCH application version is higher than the TV's SIRCH version.
- You must check the SIRCH application version to ensure it is compatible with the TV firmware version.
- The SIRCH function is not supported for satellite channels.
(To use the SIRCH function in satellite models, make sure to set the Power On Channel to an Air or Cable channel.)

- SIRCH operating Diagram

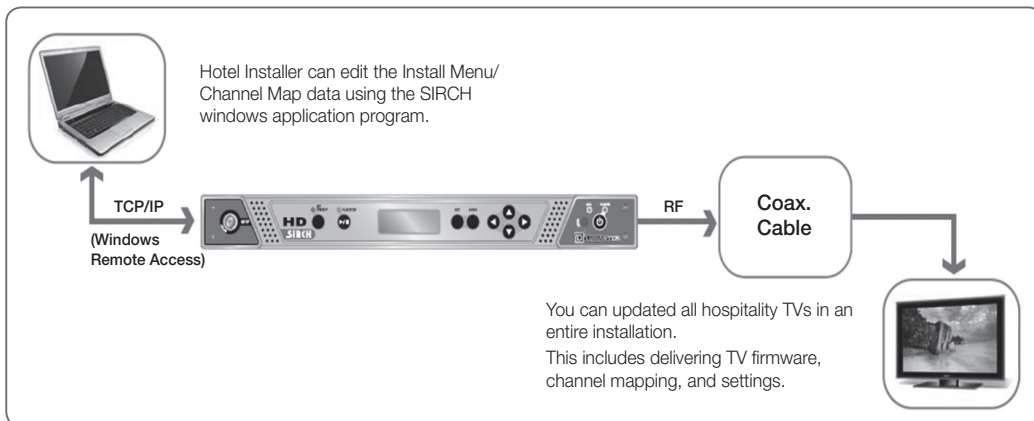

- SIRCH Installation Considerations

There are a number of factors and operations you need to consider when you set up and run SIRCH:

1. Set the SIRCH Update Time

- Normally, you would use Standby SIRCH. Standby SIRCH updates TVs when they have been in Standby mode for a certain length of time or when they are in Standby mode at a certain time every day.
- You can set the standby SIRCH value to Off, 1Hour, 2Hour, 12:00 PM, 02:00 PM, 12:00 AM, or 02:00 AM.
- The default value is 1Hour.
- When you select "1Hour" or "2Hour", 1 or 2 hours after a TV goes into Standby mode, the SIRCH upgrade starts automatically.
- If you select a specific time setting, the Standby SIRCH is performed once a day at the defined time.

2. Set the SIRCH Channel

- Use SIRCH Channel to set the PID frequency that will carry the SIRCH parameters to the TVs in the system.
- Open Cable : You can use CH2 through CH135.
- A detailed frequency table is available in the SIRCH Windows Application Program User's Manual.

3. Verify the SIRCH Version

- The SIRCH version at the headend must be a higher version than the version on the TVs for the TVs to update.
- For example, if the software version in the SIRCH PC application is 01a0, then the current TV SIRCH version on a TV must be less than this for the TV to update.
- The software version value updates to a higher value automatically each time a change is implemented.
- The software version value for the TV clone data must be in hexadecimal format.

4. Test using Manual SIRCH

- Plan to use Manual SIRCH to test whether SIRCH has been installed properly.

NOTE

- Please visit www.lumantek.com/sirch/ for more information.
- SIRCH Windows Application Program User's Manual is available at <http://www.samsung.com/us/business/hospitality>.

GENERAL INFORMATION

- **System Overview**

The 'Samsung Interactive Remote Control for Hospitality (SIRCH)' application is a Remote Control Update system for the better and cost effective service to Hospitality industries. This will allow user/operator to configure the guest TV with RF distributing system. Application will help user to set and configure the guest room TV Set parameter. The created setting file will get used by SRCUS for configuration of guest TV.

Application is intended to create or modify clone files for user and to update guest TV with these clone files by transmitting them with RF. Application provides a user interface similar in appearance to TV's parameter settings where user can update factory menu settings and can modify or tune channels to update guest TVs.

To effectively complete and support the requirements of the "Hospitality" Industry, a management system is needed that will allow the operator to have control of the TV sets in the guest's room without requiring a potential disruptive or costly visit to each room

- **Channel Configuration Made Easy All from the Head End FMA System.**
- **Will configure and deliver the channel line-up and SW upgrade to the guest room terminals via the hotel's coaxial distribution.**

This application is an S/W utility to configure user configuration parameter defined below:

- **Hotel Factory Menu (Standalone Menu/Interactive Menu)**
- **Channel map**

It also supports generation of TS stream embedding clone file information and control of the modulator which is used for broadcast of TS stream.

- **Purpose of the Document**

This document is prepared to facilitate and guide the user how to create/modify clone files, to update interactive/standalone menu settings, to configure channel map and to create TS stream using SIRCH. Screens-wise explanations are provided here in this document in the process flow of the application.

GETTING STARTED

- **Installation instructions for Windows XP/Vista/2007**

1. To install Samsung Interactive Remote Control for Hospitality (SIRCH), locate and open the setup directory of SIRCH and double-click on the file "setup.exe".

2. Click on Next Button to proceed for Installation wizard of SIRCH.

3. Read the license agreement carefully and select "I accept the terms in the license agreement" and click on Next button.

4. Please enter User and Organization information and click on Next to proceed.

5. Click Next to install the application files to the default folder, or click Change to install to a different folder.

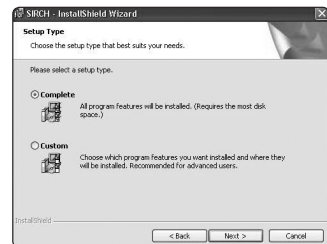
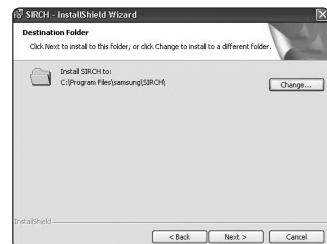
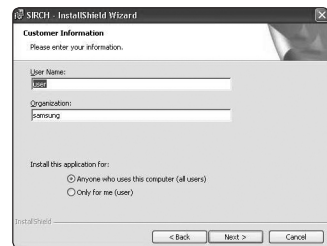
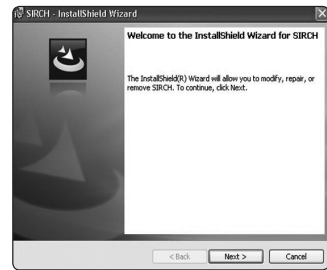

6. Choose the setup type (Complete / Custom) that best suits your needs. Complete is recommended for users as it will install all program features.
7. The wizard is ready to begin installation. Click on Install to begin the installation.

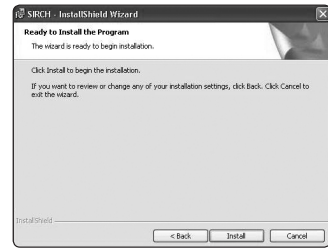

8. After installation process completes, Click Finish to exit the wizard.
9. After clicking on finish a desktop icon is made for launching SIRCH application and also it is added in your Start Menu → Programs.



- **Launching/Starting SIRCH Application**

1. To launch SIRCH, either user can double-click on the icon made on desktop named "SIRCH.exe" or user can go to Start Menu → Programs → Samsung → SIRCH → SIRCH.exe.
2. Application will launch a window asking to select Mode and Model to proceed.
3. User can choose options form File Menu to proceed to his specific application requirement.

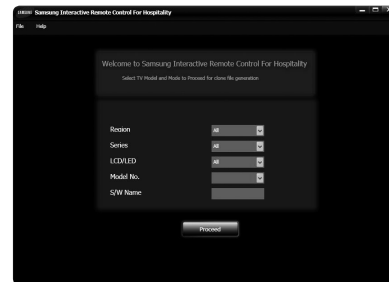

- **Uninstalling SIRCH Application**

1. To uninstall SIRCH go to StartMenu → Programs → Samsung → SIRCH → Uninstall.exe.
2. Follow the steps of uninstall wizard.

- **Create New Clone Files**

After launching SIRCH, application will show a window asking for Model and Mode selection. Application starts with the utility to create new clone files thus other utilities can be called from File Menu. To create new files user may follow the following steps:

1. To create new file, either launch SIRCH.exe or choose Create New File from File Menu.
2. Select series, region, LCD/LED type of the model from the drop down boxes. If user doesn't know the series, region or type of the model, he can select "All".
3. Selecting Region, Series and type will filter out the Models in Modelno. Dropdown box.
4. Select TV Model from the drop down box in front of "Model" Option.
5. After selecting Model no. S/w name of the model will shown in S/W name box.
6. Click on Proceed button.

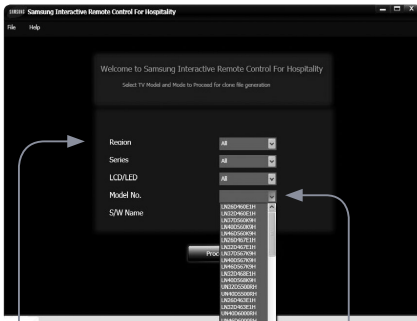
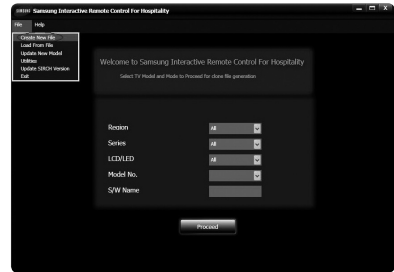

Select Model's Series, Region, LCD/LED

Select TV Model

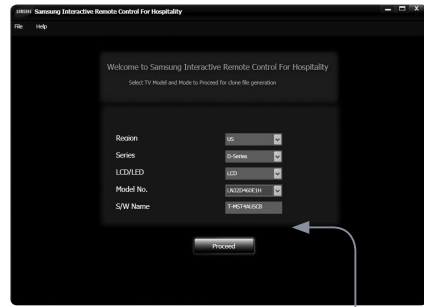

Software Name for selected TV Model appears

- **Modify existing Clone files**

To modify the existing clone files user must follow the following steps:

1. Go to File Menu → Load from file. If the option is disabled user is probably on the next screen so he must come back to main screen by clicking back button.
2. After clicking on Load from file, a browser window will open which will ask user to locate clone file folder. User must locate the immediate parent folder of the files not the folder named with version no.
3. After locating files click on **OK**.
4. Model no, Region, Series, Type and S/w name will be uploaded from clone files and made visible to user. Though user is not allowed to change them.
5. Click on Proceed button.
6. All Hospitality option menu settings and channels in channel map will be loaded from the files. User can change them and can save or overwrite.

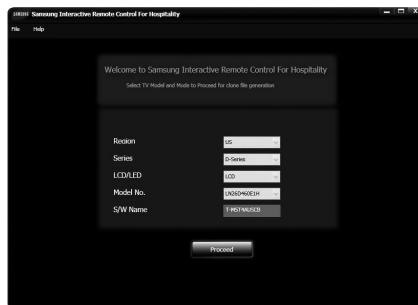

- **Hospitality Options Setting**

After clicking “Proceed” button, application will navigate user to next screen with different tabs (Hospitality Options, channel map and generate). User can navigate to other Tabs , this will not lead to any loss of unsaved data.

To modify factory menu settings user may follow the following steps:

1. Select Hospitality Options Tab.
2. Application will show Blue labels and drop down boxes in front of each labels which have their different values.
3. User may select any value from the drop down box to change some parameter.
4. Default values are selected are shown according to that particular TV Model’s default settings, if user doesn’t make changes.
5. Dark and Dim labels are the parameter which user cannot change and are disabled.
6. To set logo user can click on logo Download which will navigate him to a file browser window.
7. User should Click save button only when all settings are done including Channel Map settings because save button will generate Clone files. Thus user should not confuse himself that there is different save button for every Tab.

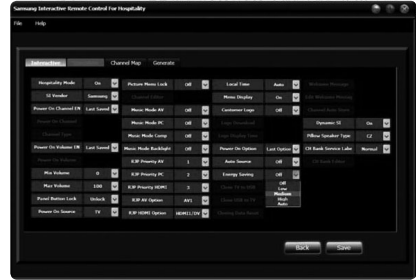

Hospitality Option TAB



Drop Down Box to change default values

Disabled Parameters

- **Channel Map Configuration**

Channel Map tab shows a list of channels in a table where for every channel, channel name, PTC no., Program No., Modulation and Program Type are shown. Channel map information is only configured for English language. Though channel names in any other language in clone file loaded from TV will remain undisturbed after changes from SIRCH application. Channel category is a list of options for Air, Cable, Satellite and All, at left of the table. All is selected as default, which shows every channel existing in the map. By selecting Analog or Digital user can filter channel list in the table. User can add a new channel, edit existing channel in list or delete it by clicking on add, edit and delete buttons respectively. Edit Button also shows complete information for a channel in the list which can be modified by user.



- **Add a New Channel**

To add a new channel user must follow following steps:

1. Select Air, Cable or Satellite whichever type of channel user wants to add.
2. Select Analog or Digital.
3. Then click on the Add button. Application will pop up an Add New Channel Window.
4. Fill and complete respective fields and drop down boxes for the channel to add, like Name, Major No., Minor No., Program Type etc. These fields and their name will shown depend on selected region.
5. Click on Add Button to add the channel otherwise click Cancel.

(For DTV channels in ATSC models display number has two fields (major-minor) which can be set to any vaules from 0 to 999.)

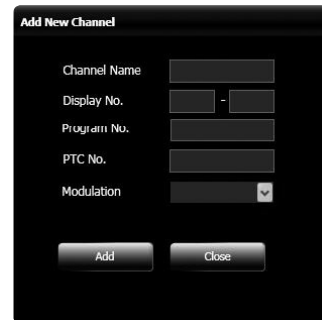

- **Modify an existing Channel from the list**

To modify parameters (like PTC no., Program type, etc) of an existing channel from the list user must follow the following steps:

1. Select Air, Cable or Satellite whichever type of channel user wants to edit.
2. Select Analog or Digital.
3. Select the channel from the list to Modify and click on Modify button.
4. Modify the respective fields and drop down boxes for the channel to edit.
5. Click on Edit Button to modify the channel otherwise click Cancel

(For DTV channels in ATSC models display number has two fields (major-minor). Channel display number minor part can be changed from SIRCH application but not from TV.)

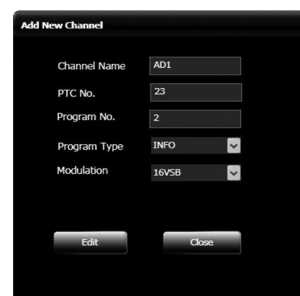

- **Delete a Channel from the list**

To delete an existing channel from the list user must follow the following steps:

1. Select Air, Cable or Satellite whichever type of channel user wants to delete.
2. Select Analog or Digital.
3. Select the channel from the list to Delete and click on Delete button.

- **Channel - Editor**

To change display no. or channel name user must follow the following steps:

1. Select Air, Cable or Satellite whichever type of channels user wants to edit.
2. Select Analog or Digital.
3. Select the channel from the list to Edit and click on Channel-Edit button.
4. Change the display no. or Channel name of the channel. Click on OK Button to edit the channel.
5. If a new display no. already exists, application will ask user to modify the display number. On clicking Yes, application will swap the new channel with the existing one.

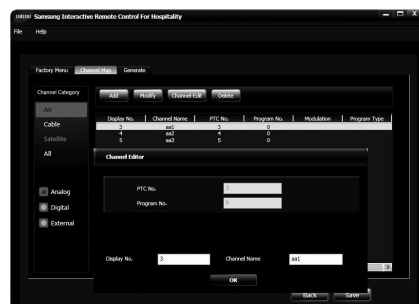

- **Saving Clone Files**

To save the clone files with modified parameters and channel map configuration user must follow the following steps:

1. When user has done all the changes in Interactive/Standalone menu and in Channel map, click on the Save Button.
2. A browser window will open, which will ask for location to save the clone files.
3. Select the folder where clone files should be saved or make a new folder and click Ok.
4. After clicking Ok files will be saved with inside a folder named with version no. of the model. User can find clone files inside (Location given by user) → (Version no, of Model) → Clone.



- **Going Back to Main Screen**

1. To go back to main screen click on Back button.
2. This operation will not save all you parameter changes or channel map configuration, so be sure to save clone files before going back and select some different model.

- **Merging with TS- Stream**

To merge clone file with TS-stream follow following steps:

1. Go to File Menu → Utility → Generate and click on Launch TS-Merge.
2. Please read about Update version clauses [2.13] before merge.
3. Select Merge Clone files radio button to clone files.
4. Browse Clone files folder.
5. Browse seed stream folder.
6. Click on generate button to generate stream and output stream will be generated. This step will take few minutes to create output stream.

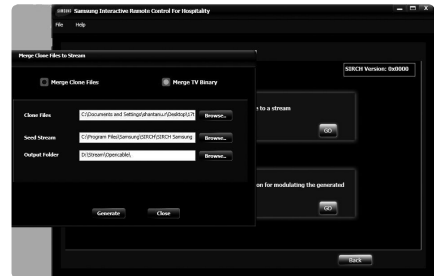

- **Launching Ventus application**

Go to File Menu → Utility → Generate and click on GO for Launch Ventus

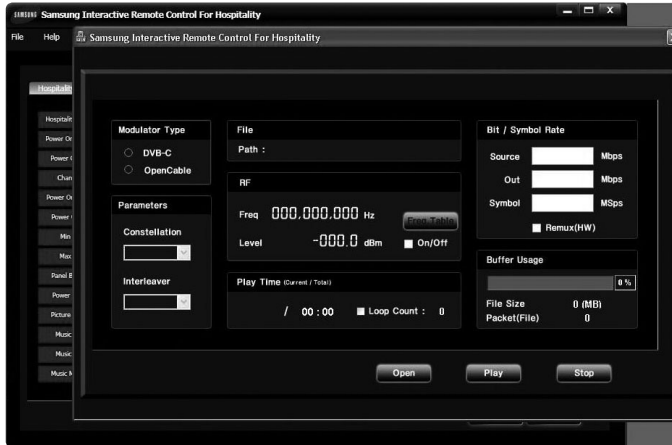

- **Upgrading clone or binary file on TV**

To upgrade the clone for binary file on TV, keep prepared merged stream (Binary_outputstream.mpg or clone_outputstream.mpg).

1. Locate stream file in Modulator utility (as explained in 2.11).
2. Set the set channel to broadcast the stream by clicking on Frequency Table.
3. Select Opencable for ATSC or DVB-C for DVB models.
4. Click Play Button to broadcast the stream.
5. In TV's factory menu, **SIRCH** channel must be same as the channel on which stream is broadcasting.
6. And SIRCH version must be smaller than the software version set before generating stream file.
7. Click on Manual **SIRCH**. (Please check channel setup is set to Cable not Air if cable is connected to TV for broadcasting.)

- **Updating the application with new Model**

To update the application with new model, so that you can configure the clone files for that model user must possess a model installation XML file. To update new model user must follow following steps:

1. Go to File Menu → Update New Model.
2. A window (Add/Update Model) will open and asks user to enter Configuration file (Model installation xml file).
3. To locate model installation xml file click on browse button. A file browser window will open where user can locate the file.
4. After selecting the installation file, window will show model name, series, region and TV model name in the textboxes which are disabled to user.
5. To add model click on Add button. If model already exists application will update the model otherwise it will add the model in the model dropdown box.
6. To close the window click on Close button.



- **Update SIRCH Version**

To update **SIRCH** version for Clone and user should follows as below.

1. Go to File Menu → Update Software Version.
2. A window will open which ask for Software Version (Clone File Up gradation).
3. User should provide higher version than TV version in version value. E.g.
 - i) If software version is set as 01a0 in **SIRCH** PC application, then current TV **SIRCH** version should be less than this value for update.
4. Software version value for clone should in hexadecimal format e.g. fa1b but less than ffff.
5. After provide value click on Update button for update version value.



- **Closing the application**

1. To close the application either click the close button on top right corner or go File Menu and Exit.

- **FAQs**

If **SIRCH** seems to have a problem, first review this list of possible problems and solutions.

- Test SIRCH modulator controller settings:

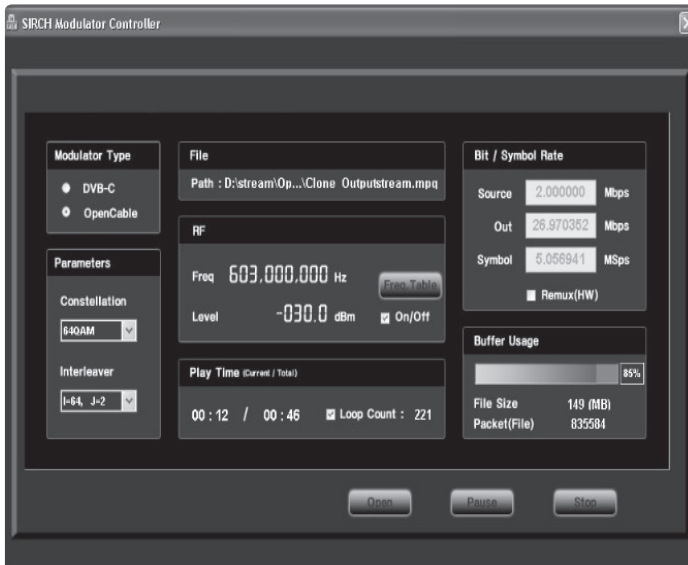

- The **SIRCH** upgrade only support OpenCable & DVB-C
- Recommended setting
 - Parameters Constellation: 64 QAM
 - Remux(H/W) : Off
- **SIRCH** Frequency should be matched **SIRCH** Channel of TV.
 - If you change frequency table, please refer the frequency table in **SIRCH** manual (Appendix A).
 - You should set same channel in both **SIRCH** PC program and in TV. For ex. if you have empty 2channel (57MHz) in Hotel, you should set 2channel(57MHz) both **SIRCH** PC program and TV.
 - Default initial value : **SIRCH** 87 (603MHz), TV **SIRCH** Channel : 87

- **Test version information while merging files into stream :**

- To merge clone files ensure while merging SIRCH clone version in SIRCH PC program should be greater than the SIRCH version stored in TV.
- To merge binary file ensure the binary merged into the stream has higher version than the binary already updated in TV.

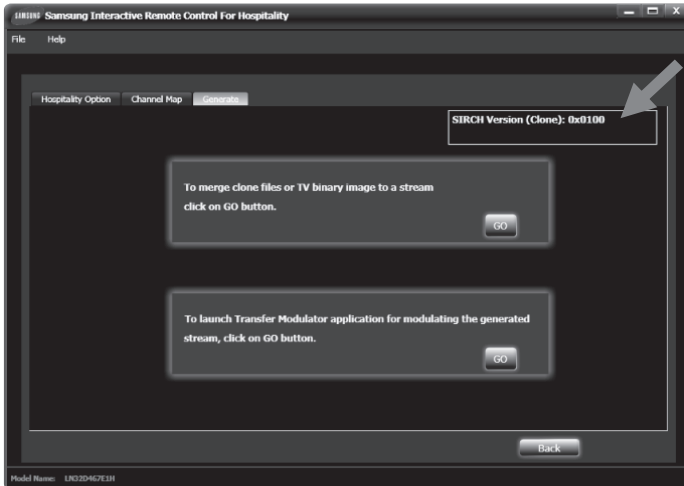

- TV SIRCH version should be less than SIRCH PC application value for update.
 - PC application: SIRCH Version (Clone): 0002, TV SIRCH Version: 0001. Update is possible. After update TV version will be set equal to SIRCH PC version, hence TV will be 0002.
 - PC application: SIRCH Version (Clone): 0002, TV SIRCH Version: 0002. Update is not possible.



- Merge TV Binary : support to upgrade Main SW.
 - You need to contact to Samsung to have Merge TV Binary.
 - Merge TV Binary could not support to upgrade Sub Micom

- Merged TS Stream should be located in D:\stream\OpenCable(US) or D:\stream\DVBC(EU)

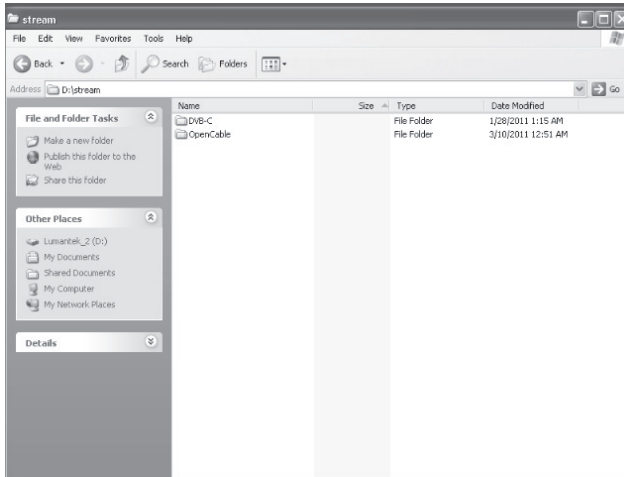

- You can check displaying SIRCH merged stream if you tune SIRCH channel.

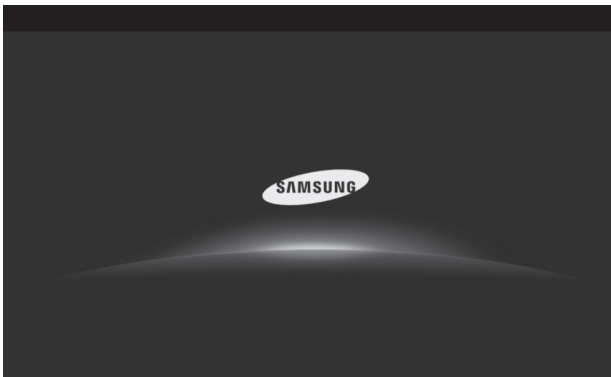

- Cautions for Hospitality mode options

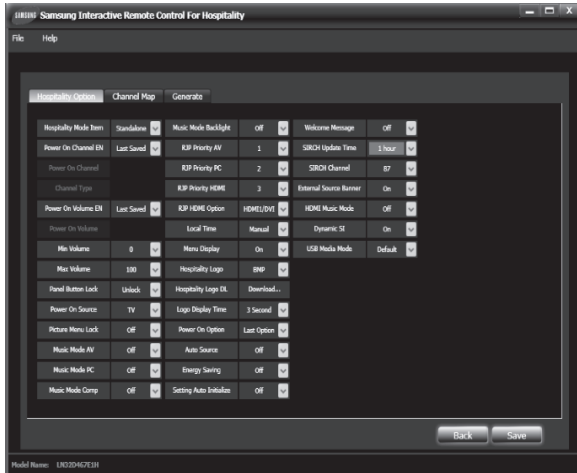

- Hospitality Mode: should be Standalone. - Interactive mode could not support SIRCH.
- Power On Source must be set TV. If you select others external source, SIRCH cannot support upgrade.
- If you try to upgrade SIRCH in external source (PC/HDMI...), SIRCH could not support upgrade by manual SIRCH / SIRCH Update Time.
- SIRCH Upgrade Time: not off.
- Dynamic SI should be set 'Off' to modify DTV display channel map in channel map tap.

- Which all TV broadcasting standard supported by SIRCH application?

SIRCH application support only ATSC and DVB .

- How to add channels for DVB /ATSC?

User need to select particular TV region and model no. On basis of these parameter application allow to add channel for DVB(for EU) or ATSC (for US). Please refer section 2.7.

- What all broadcasting type SIRCH Modulator supports?

SIRCH modulator support only DVB-C (for DVB)and OpenCable(for ATSC) standard for broadcasting.

- What is difference b/w Channel in channel map and Channel configured in SIRCH modulator?

- Channel in Channel Map are used watch channel on TV. We can add more than one channel in channel map. It is in form of clone data and transfer using seed stream. On other hand Channel configured in SIRCH modulator is used for broadcast data (clone or binary) from modulator with fixed frequency or channel number. This same channel number is used on TV named as SIRCH channel for software update. (Please refer Appendix A).

Installing the Wall Mount

The wall mount kit (sold separately) allows you to mount the TV on the wall. For detailed information on installing the wall mount, see the instructions provided with the wall mount. Contact a technician for assistance when installing the wall mount bracket. We do not advise you to do it yourself.

Samsung Electronics is not responsible for any damage to the product or injury to yourself or others if you elect to install the TV on your own.

Wall Mount Kit Specifications (VESA)

 Wall mount kit is not supplied but sold separately.

Install your wall mount on a solid wall perpendicular to the floor. When attaching to other building materials, please contact your nearest dealer. If installed on a ceiling or slanted wall, it may fall and result in severe personal injury.

NOTE

- Standard dimensions for wall mount kits are shown in the table below.
- When purchasing our wall mount kit, a detailed installation manual and all parts necessary for assembly are provided.
- Do not use screws that do not comply with the VESA standard screw specifications.
- Do not use screws longer than the standard dimension, as they may cause damage to the inside of the TV set.
- For wall mounts that do not comply with the VESA standard screw specifications, the length of the screws may differ depending on their specifications.
- Do not fasten the screws too strongly, this may damage the product or cause the product to fall, leading to personal injury. Samsung is not liable for these kinds of accidents.
- Samsung is not liable for product damage or personal injury when a non-VESA or non-specified wall mount is used or the consumer fails to follow the product installation instructions.
- Do not exceed 15 degrees tilt when mounting this TV.

inches	VESA Spec. (A * B)	Standard Screw	Quantity
19~22	75 X 75	M4	4
26	100 X 100		
32~40	200 X 200	M6	
46~60	400 X 400	M8	

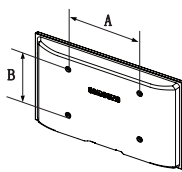

Do not install your Wall Mount Kit while your TV is turned on. It may result in personal injury due to electric shock.

Securing the TV to the Wall



Caution: Pulling, pushing, or climbing onto the TV may cause the TV to fall. In particular, ensure that your children do not hang over or destabilize the TV; doing so may cause the TV to tip over, resulting in serious injuries or death. Follow all safety precautions provided on the included Safety Flyer. For added stability, install the anti-fall device for safety purposes, as follows.

To avoid the TV from falling

1. Put the screws into the clamps and firmly fasten them onto the wall. Confirm that the screws have been firmly installed onto the wall.

 You may need additional material such as an anchor depending on the type of wall.

 Since the necessary clamps, screws, and string are not supplied, please purchase these additionally.

2. Remove the screws from the centre back of the TV, put the screws into the clamps, and then fasten the screws onto the TV again.

 Screws may not be supplied with the product. In this case, please purchase the screws of the following specifications.

3. Connect the clamps fixed onto the TV and the clamps fixed onto the wall with a strong string and then tie the string tightly.



NOTE

- Install the TV near to the wall so that it does not fall backwards.
 - It is safe to connect the string so that the clamps fixed on the wall are equal to or lower than the clamps fixed on the TV.
 - Untie the string before moving the TV.
4. Verify all connections are properly secured. Periodically check connections for any sign of fatigue for failure. If you have any doubt about the security of your connections, contact a professional installer.

Anti-theft Kensington Lock

The Kensington Lock is not supplied by Samsung. It is a device used to physically fix the system when using it in a public place. The appearance and locking method may differ from the illustration depending on the manufacturer. Refer to the manual provided with the Kensington Lock for additional information on proper use.

To lock the product, follow these steps:

 Please find a “” icon on the rear of the TV. A Kensington slot is beside the “” icon.

1. Wrap the Kensington lock cable around a large, stationary object such as desk or chair.
2. Slide the end of the cable with the lock attached through the looped end of the Kensington lock cable.
3. Insert the locking device into the Kensington slot on the product (❶).
4. Lock the lock.

 These are general instructions. For exact instructions, see the User manual supplied with the locking device.

 The locking device has to be purchased separately.

 The location of the Kensington Lock may be different depending on its model.

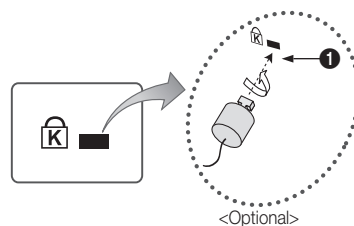

Specifications

Display Resolution	1920 x 1080		
Environmental Considerations			
Operating Temperature	50°F to 104°F(10°C to 40°C)		
Operating Humidity	10% to 80%, non-condensing		
Storage Temperature	-4°F to 113°F(-20°C to 45°C)		
Storage Humidity	5% to 95%, non-condensing		
Stand Swivel (Left / Right)	-20° ~ 20°		
Model Name	HG40AA690	HG46AA690	HG32NA790
Screen Size	40 inches	46 inches	32 inches
Power Consumption			
Normal operation	TBD	TBD	43.1W
Standby			
Sound (Output)	10W x 2		
Dimensions (WxDxH)			
Body	927.4 X 46.9 X 554.7 mm	1062.8 X 46.9 X 631.1 mm	739.6 X 46.9 X 448.0 mm
With stand	927.4 X 227.7 X 608.4 mm	1062.8 X 227.7 X 684.8 mm	739.6 X 241.3 X 514.8 mm
Weight			
Without Stand	10.3 kg	13.2 kg	6.5 kg
With Stand	13.2 kg	16.1 kg	8.5 kg
Model Name	HG40NA790	HG46NA790	HG55NA790
Screen Size	40 inches	46 inches	55 inches
Power Consumption			
Normal operation	55W	58.9W	67.7W
Standby			
Sound (Output)	10W x 2		
Dimensions (WxDxH)			
Body	926.8 X 46.9 X 553.4 mm	1062.2 X 46.9 X 629.8 mm	1252.8 X 46.9 X 736.6 mm
With stand	926.8 X 241.3 X 619.1 mm	1062.2 X 276.6 X 700.8 mm	1252.8 X 276.6 X 807.6 mm
Weight			
Without Stand	10.3 kg	12.9 kg	16.2 kg
With Stand	13.2 kg	15.8 kg	19.1 kg

 Design and specifications are subject to change without prior notice.

 For information about power supply, and more about power consumption, refer to the label attached to the product.

HDMI

The terms HDMI and HDMI High-Definition Multimedia Interface, and the HDMI Logo are trademarks or registered trademarks of HDMI Licensing LLC in the United States and other countries.



Contact SAMSUNG WORLDWIDE

If you have any questions or comments relating to Samsung products, please contact the SAMSUNG customer care center.

Country	Customer Care Centre ☎
AUSTRIA	800-112233
FINLAND	0771-400002
FRANCE	0825-022062
GERMANY	01805-471101
HUNGARY	0640-985985
ITALIA	800-194194
NETHERLANDS	015-2197000
POLAND	0-801-B2BSAM (222726)
PORTUGAL	808-B2BSAM
SPAIN	0902024-010
UNITED KINGDOM	+44 (0) 845 8414141
SOUTH AFRICA	0860-SAMSUNG (726-7864)
U.A.E	800-SAMSUNG (726-7864) 8000-4726



BN68-04282R-00

© 2012 Samsung Electronics Co., Ltd. All rights reserved.