

**BDL4620QL**



[www.philips.com/welcome](http://www.philips.com/welcome)

User Manual (English)

**PHILIPS**

## Safety Instructions

### Warnings and Precautions

#### KNOW THESE SAFETY SYMBOLS



**CAUTION:** TO REDUCE THE RISK OF ELECTRIC SHOCK, DO NOT REMOVE COVER (OR BACK). NO USER-SERVICEABLE PARTS INSIDE. REFER SERVICING TO QUALIFIED SERVICE PERSONNEL.



This symbol indicates high voltage is present inside. It is dangerous to make any kind of contact with any inside part of this product.



This symbol alerts you that important literature concerning operation and maintenance has been included with this product.

**CAUTION:** FCC/CSA regulations state that any unauthorized changes or modifications to this equipment may void the user's authority to operate it.

**CAUTION:** To prevent electric shock, match the wide blade of plug to the wide slot, and fully insert the plug.

TO PREVENT DAMAGE WHICH MAY RESULT IN FIRE OR ELECTRIC SHOCK HAZARD, DO NOT EXPOSE THIS APPLIANCE TO RAIN OR MOISTURE.

The Socket-outlet should be installed near the apparatus and be easily accessible.



#### Read and follow these instructions when connecting and using your Public Information Display:

- Unplug the display if you are not going to use it for an extensive period of time.
- Unplug the display if you need to clean it with a slightly damp cloth. The screen may be wiped with a dry cloth when the power is off. However, never use alcohol, solvents or ammonia-based liquids.
- Consult a service technician if the display does not operate normally when you have followed the instructions in this manual.
- The casing cover should be opened only by qualified service personnel.
- Keep the display out of direct sunlight and away from stoves or any other heat sources.
- Remove any object that could fall into the vents or prevent proper cooling of the display's electronics.
- Do not block the ventilation holes on the cabinet.
- Keep the display dry. To avoid electric shock, do not expose it to rain or excessive moisture.
- If turning off the display by detaching the power cable, wait for 6 seconds before re-attaching the power cable for normal operation.
- To avoid the risk of shock or permanent damage to the set do not expose the display to rain or excessive moisture.
- When positioning the display, make sure the power plug and outlet are easily accessible.
- **IMPORTANT:** Always activate a screen saver program during your application. If a still image in high contrast remains on the screen for an extended period of time, it may leave an 'after-image' or 'ghost image' on the front of the screen. This is a well-known phenomenon that is caused by the shortcomings inherent in LCD technology. In most cases the afterimage will disappear gradually over a period of time after the power has been switched off. Be aware that the after-image symptom cannot be repaired and is not covered under warranty.

## Important Safety Instructions

1. Read these instructions.
2. Keep these instructions.
3. Heed all warnings.
4. Follow all instructions.
5. Do not use this apparatus near water.
6. Clean only with dry cloth.
7. Do not block any ventilation openings. Install in accordance with the manufacturer's instructions.
8. Do not install near any heat sources such as radiators, heat registers, stoves, or other apparatus (including amplifiers) that produce heat.
9. Do not defeat the safety purpose of the polarized or grounding-type plug. A polarized plug has two blades with one wider than the other. A grounding type plug has two blades and a third grounding prong. The wide blade or the third prong are provided for your safety. If the provided plug does not fit into your outlet, consult an electrician for replacement of the obsolete outlet.
10. Protect the power cord from being walked on or pinched particularly at plugs, convenience receptacles, and the point where they exit from the apparatus.
11. Only use attachments/accessories specified by the manufacturer.
12. Use only with the cart, stand, tripod, bracket, or table specified by the manufacturer, or sold with the apparatus. When a cart is used, use caution when moving the cart/apparatus combination to avoid injury from tip-over.
13. Unplug this apparatus during lightning storms or when unused for long periods of time.
14. Refer all servicing to qualified service personnel. Servicing is required when the apparatus has been damaged in any way, such as power-supply cord or plug is damaged, liquid has been spilled or objects have fallen into the apparatus, the apparatus has been exposed to rain or moisture, does not operate normally, or has been dropped.



**CAUTION:** These servicing instructions are for use by qualified service personnel only. To reduce the risk of electric shock, do not perform any servicing other than that contained in the operating instructions unless you are qualified to do so.

**CAUTION:** Excessive sound pressure from earphones and headphones can cause hearing loss. Adjustment of the equalizer to maximum increases the earphone and headphone output voltage and the sound pressure level. Therefore, to protect your hearing, adjust the equalizer to an appropriate level.

**For UL/CUL application:** For use only with UL Listed Wall Mount Bracket with minimum weight/load: **41.1 kg**.

**For CB application:** Unit without base weight: **13.7 kg**. The equipment and its associated mounting means still remain secure during the test. (Used wall mounting kit: **400 x 400 mm** distance by using **M6** screws of **20 mm** long plus the thickness of the mounting bracket.)

**WARNING:** TO REDUCE THE RISK OF FIRE OR ELECTRIC SHOCK, DO NOT EXPOSE THIS APPARATUS TO RAIN OR MOISTURE.

**WARNING:** Apparatus shall not be exposed to dripping or splashing and no objects filled with liquids, such as vases, shall be placed on the apparatus.

**WARNING:** The batteries (batteries installed) shall not be exposed to excessive heat such as sunshine, fire or the like.

**WARNING:** The mains plug or appliance coupler is used as the disconnect device, the disconnect device shall remain readily operable.

**WARNING:** To prevent the spread of fire, keep candles or other open flames away from this product at all times.



**WARNING:** To prevent injury, this apparatus must be securely attached to the floor/wall in accordance with the installation instructions.

## Regulatory Information

### CE Declaration of Conformity

We declare under our responsibility that the product is in conformity with the following standards:

- EN60065:2002+A1:2006+A11:2008+A2:2010+A12:2011 (Safety requirement of Audio, video and similar electronic apparatus)
- EN55022:2010 (Radio Disturbance requirement of Information Technology Equipment)
- EN55024:2010 (Immunity requirement of Information Technology Equipment)
- EN61000-3-2:2006 +A1:2009+A2:2009 (Limits for Harmonic Current Emission)
- EN61000-3-3:2008 (Limitation of Voltage Fluctuation and Flicker)
- EN 50581:2012 (Technical documentation for the assessment of electrical and electronic products with respect to the restriction of hazardous substances)

following provisions of directives applicable:

- 2006/95/EC (Low Voltage Directive)
- 2004/108/EC (EMC Directive)
- 2009/125/EC (ErP Directive, EC No. 1275/2008, 642/2009 Implementing Directive for Standby and Off mode power consumption)
- 93/68/EEC (Amendment of EMC and Low Voltage Directive) and is produced by a manufacturing organization on ISO9000 level.
- 2011/65/EU (RoHS 2 Directive)

## Federal Communications Commission (FCC) Notice (U.S. Only)



This equipment has been tested and found to comply with the limits for a Class B digital device, pursuant to Part 15 of the FCC Rules. These limits are designed to provide reasonable protection against harmful interference when the equipment is operated in a commercial environment. This equipment generates, uses and can radiate radio frequency energy and, if not installed and used in accordance with the instructions manual, may cause harmful interference to radio communications. Operation of this equipment in a residential area is likely to cause harmful interference in which case the user will be required to correct the interference at his own expense.



Changes or modifications not expressly approved by the party responsible for compliance could void the user's authority to operate the equipment.

Use only an RF shielded cable that was supplied with the display when connecting this display to a computer device.

To prevent damage which may result in fire or shock hazard, do not expose this appliance to rain or excessive moisture.

THIS CLASS B DIGITAL APPARATUS MEETS ALL REQUIREMENTS OF THE CANADIAN INTERFERENCE- CAUSING EQUIPMENT REGULATIONS.



This device complies with Part 15 of the FCC Rules. Operation is subject to the following two conditions: (1) this device may not cause harmful interference, and (2) this device must accept any interference received, including interference that may cause undesired operation.

## Polish Center for Testing and Certification Notice

The equipment should draw power from a socket with an attached protection circuit (a three-prong socket). All equipment that works together (computer; display; printer; and so on) should have the same power supply source.

The phasing conductor of the room's electrical installation should have a reserve short-circuit protection device in the form of a fuse with a nominal value no larger than 16 amperes (A).

To completely switch off the equipment, the power supply cable must be removed from the power supply socket, which should be located near the equipment and easily accessible.

A protection mark "B" confirms that the equipment is in compliance with the protection usage requirements of standards PN-93/T-42107 and PN-89/E-06251.

### Wymagania Polskiego Centrum Badań i Certyfikacji

Urządzenie powinno być zasilane z gniazda z przyłączonym obwodem ochronnym (gniazdo z kołkiem). Współpracujące ze sobą urządzenia (komputer, monitor, drukarka) powinny być zasilane z tego samego źródła.

Instalacja elektryczna pomieszczenia powinna zawierać w przewodzie fazowym rezerwową ochronę przed zwarciami, w postaci bezpiecznika o wartości znamionowej nie większej niż 16A (amperów).

W celu całkowitego wyłączenia urządzenia z sieci zasilania, należy wyjąć wtyczkę kabla zasilającego z gniazda, które powinno znajdować się w pobliżu urządzenia i być łatwo dostępne.

Znak bezpieczeństwa "B" potwierdza zgodność urządzenia z wymaganiami bezpieczeństwa użytkownika zawartymi w PN-93/T-42107 i PN-89/E-06251.

### Pozostałe instrukcje bezpieczeństwa

- Nie należy używać wtyczek adapterowych lub usuwać kołka obwodu ochronnego z wtyczki. Jeżeli konieczne jest użycie przedłużacza to należy użyć przedłużacza 3-żyłowego z prawidłowo połączonym przewodem ochronnym.
- System komputerowy należy zabezpieczyć przed nagłymi, chwilowymi wzrostami lub spadkami napięcia, używając eliminatora przepięć, urządzenia dopasowującego lub bezzakłócenowego źródła zasilania.
- Należy upewnić się, aby nic nie leżało na kablach systemu komputerowego, oraz aby kable nie były umieszczone w miejscu, gdzie można byłoby na nie nadeptywać lub potykać się o nie.
- Nie należy rozlewać napojów ani innych płynów na system komputerowy.
- Nie należy wypychać żadnych przedmiotów do otworów systemu komputerowego, gdyż może to spowodować pożar lub porażenie prądem, poprzez zwarcie elementów wewnętrznych.
- System komputerowy powinien znajdować się z dala od grzejników i źródeł ciepła. Ponadto, nie należy blokować otworów wentylacyjnych. Należy unikać kładzenia luźnych papierów pod komputer oraz umieszczania komputera w ciasnym miejscu bez możliwości cyrkulacji powietrza wokół niego.

## Electric, Magnetic and Electromagnetic Fields ("EMF")

1. We manufacture and sell many products targeted at consumers, which, like any electronic apparatus, in general have the ability to emit and receive electromagnetic signals.
2. One of our leading Business Principles is to take all necessary health and safety measures for our products, to comply with all applicable legal requirements and to stay well within the EMF standards applicable at the time of producing the products.
3. We are committed to develop, produce and market products that cause no adverse health effects.
4. We confirm that if its products are handled properly for their intended use, they are safe to use according to scientific evidence available today.
5. We play an active role in the development of international EMF and safety standards, enabling us to anticipate further developments in standardization for early integration in its products.

## Information for U.K. only

### WARNING – THIS APPLIANCE MUST BE EARTHED.

#### Important:

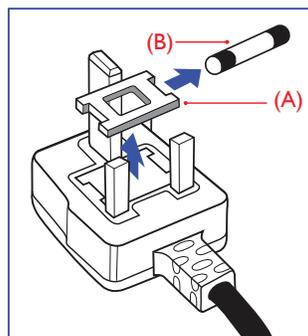

This apparatus is supplied with an approved moulded 13A plug. To change a fuse in this type of plug proceed as follows:

1. Remove fuse cover and fuse.
2. Fit new fuse which should be a BS 1362 5A, A.S.T.A. or BSI approved type.
3. Refit the fuse cover:

If the fitted plug is not suitable for your socket outlets, it should be cut off and an appropriate 3-pin plug fitted in its place.

If the mains plug contains a fuse, this should have a value of 5A. If a plug without a fuse is used, the fuse at the distribution board should not be greater than 5A.

**NOTE:** The severed plug must be destroyed to avoid a possible shock hazard should it be inserted into a 13A socket elsewhere.

#### How to connect a plug

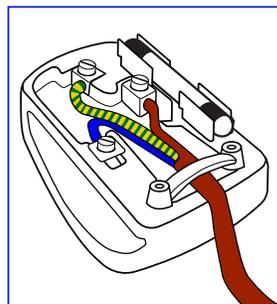

The wires in the mains lead are coloured in accordance with the following code:

BLUE – "NEUTRAL" ("N")

BROWN – "LIVE" ("L")

GREEN & YELLOW – "EARTH" ("E")

1. The GREEN & YELLOW wire must be connected to the terminal in the plug which is marked with the letter "E" or by the Earth symbol or coloured GREEN or GREEN & YELLOW.
2. The BLUE wire must be connected to the terminal which is marked with the letter "N" or coloured BLACK.
3. The BROWN wire must be connected to the terminal which is marked with the letter "L" or coloured RED.

Before replacing the plug cover, make certain that the cord grip is clamped over the sheath of the lead – not simply over the three wires.



## North Europe (Nordic Countries) Information

Placering/Ventilation

### **VARNING:**

FÖRSÄKRA DIG OM ATT HUVUDBRYTARE OCH UTTAG  
ÄR LÅTÅTKOMLIGA, NÄR DU STÄLLER DIN UTRUSTNING  
PÅ PLATS.

Placering/Ventilation

### **ADVARSEL:**

SØRG VED PLACERINGSFOR, AT NETLEDNINGENS STIK OG  
STIKKONTAKT ER NEMT TILGÆNGELIGE.

Paikka/Ilmankierto

### **VAROITUS:**

SIIJOITA LAITE SITEN, ETTÄ VERKKOJOHTO VOIDAAN  
TARVITTAESSA HELPOSTI IRROTTAA PISTORASIESTA.

Plassering/Ventilasjon

### **ADVARSEL:**

NÅR DETTE UTSTYRET PLESSERES, MÅ DU PASSE PÅ AT  
KONTAKTENE FOR STØMTILFØRSEL ER LETTE Å NÅ.

## End-of-Life Disposal

Your new Public Information Display contains materials that can be recycled and reused. Specialized companies can recycle your product to increase the amount of reusable materials and to minimize the amount to be disposed of.

Please find out about the local regulations on how to dispose of your old display from your local Philips dealer.

### **(For customers in Canada and U.S.A.)**

This product may contain lead and/or mercury. Dispose of in accordance to local-state and federal regulations. For additional information on recycling contact [www.eia.org](http://www.eia.org) (Consumer Education Initiative)

## Waste Electrical and Electronic Equipment- WEEE

### Attention users in European Union private households



This marking on the product or on its packaging illustrates that, under European Directive 2002/96/EC governing used electrical and electronic appliances, this product may not be disposed of with normal household waste. You are responsible for disposal of this equipment through a designated waste electrical and electronic equipment collection. To determine the locations for dropping off such waste electrical and electronic, contact your local government office, the waste disposal organization that serves your household or the store at which you purchased the product.

### End of Life Directives-Recycling



Your new Public Information Display contains several materials that can be recycled for new users.

Please dispose of according to all Local, State, and Federal laws.



As an ENERGY STAR Partner, we have determined that this product meets the ENERGY STAR guidelines for energy efficiency.

# Table Of Contents

<b>1. Unpacking and Installation.....</b>	<b>1</b>	5.2. Settings .....	13
1.1. Unpacking.....	1	5.2.1. Picture menu.....	13
1.2. Package Contents.....	1	5.2.2. Sound menu.....	14
1.3. Installation Notes.....	1	5.2.3. General settings menu.....	15
1.4. Mounting on a Wall.....	2	5.3. Network Settings.....	15
<b>2. Parts and Functions.....</b>	<b>3</b>	<b>6. Input mode.....</b>	<b>16</b>
2.1. Control Panel.....	3	<b>7. Pixel Defect Policy.....</b>	<b>17</b>
2.2. Input/Output Terminals .....	4	7.1. Pixels and Sub-pixels.....	17
2.3. Remote Control.....	5	7.2. Types of Pixel Defects + Dot Definition.....	17
2.3.1. General functions .....	5	7.3. Bright Dot Defects .....	17
2.3.2. Inserting batteries in the remote control.....	6	7.4. Dark Dot Defects .....	18
2.3.3. Handling the remote control.....	6	7.5. Proximity of Pixel Defects.....	18
2.3.4. Operating range of the remote control.....	6	7.6. Pixel Defect Tolerances .....	18
<b>3. Connection .....</b>	<b>7</b>	7.7. MURA.....	18
3.1. Connecting External Equipments.....	7	<b>8. Cleaning and Troubleshooting.....</b>	<b>19</b>
3.2. Connecting Multiple Displays .....	8	8.1. Cleaning .....	19
3.2.1. RS232C control connection (optional).....	8	8.2. Troubleshooting.....	20
3.2.2. IR connection (optional) .....	8	<b>9. Technical Specifications .....</b>	<b>21</b>
3.3. IR Pass-through Connection (optional) .....	8		
3.4. Wire-connecting to Network (optional).....	9		
<b>4. Operation.....</b>	<b>10</b>		
4.1. Watch the Connected Video Source.....	10		
4.2. Change Picture Format.....	10		
4.3. Select your Preferred Picture Settings.....	10		
4.4. Select your Preferred Sound Settings.....	10		
4.5. Play Multimedia Files.....	10		
4.5.1. Play files from computer.....	10		
4.5.2. Play multimedia files from USB device .....	11		
4.6. Play options.....	11		
4.6.1. Playing music files .....	11		
4.6.2. Playing movie files .....	12		
4.6.3. Playing photo files .....	12		
<b>5. Change your settings.....</b>	<b>13</b>		
5.1. Quick Picture and Sound.....	13		



# 1. Unpacking and Installation

## 1.1. Unpacking

- This product is packed in a carton, together with the standard accessories.
- Any other optional accessories will be packed separately.
- Due to the size and weight of this display it is recommended for two people to move it.
- After opening the carton, ensure that the contents are complete and in good condition.

## 1.2. Package Contents

Please verify that you received the following items with your package content:

- LCD display
- CD ROM
- Remote control with AAA batteries
- Power cord (1.8 m)
- VGA cable (1.8 m)
- RS232 cable (1.8 m)
- Quick start guide



CD ROM

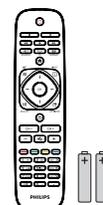

Remote Control and AAA Batteries



Quick Start Guide

\* The supplied power cord varies depending on destination.



For EU



For China



For North America



For UK



RS232 Cable

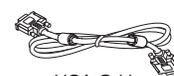

VGA Cable

### NOTES:

- For all other regions, apply a power cord that conforms to the AC voltage of the power socket and has been approved by and complies with the safety regulations of the particular country.
- Keep the package box and packing material for shipping the display.

## 1.3. Installation Notes

- Due to the high power consumption, always use the plug exclusively designed for this product. If an extended line is required, please consult your service agent.
- The product should be installed on a flat surface to avoid tipping. The distance between the back of the product and the wall should be maintained for proper ventilation. Avoid installing the product in the kitchen, bathroom or any other places with high humidity so as not to shorten the service life of the electronic components.
- The product can normally operate only under 2000 m in altitude. In installations at altitudes above 2000 m, some abnormalities may be experienced.

## 1.4. Mounting on a Wall

To mount this display to a wall, you will have to obtain a standard wall-mounting kit. We recommend using a mounting interface that complies with UL1678 standard in North America.

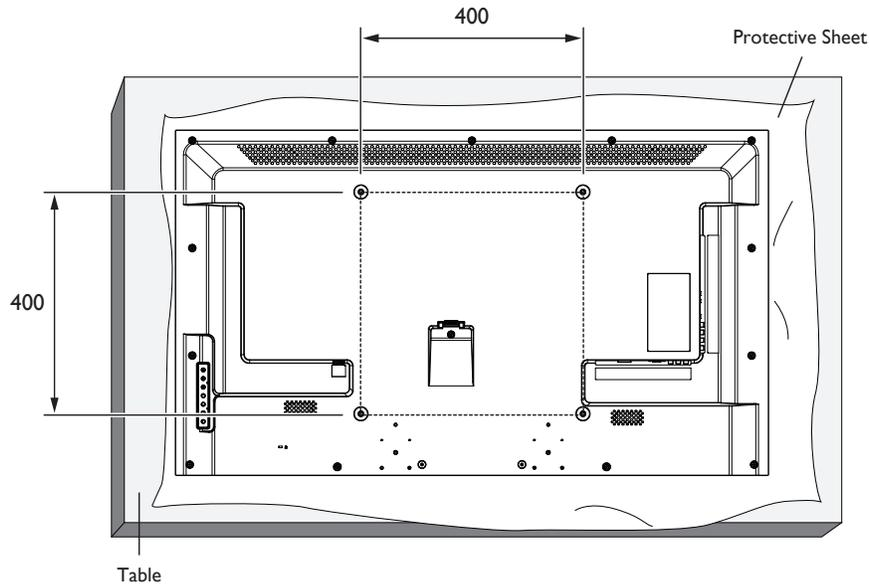

1. Lay a protective sheet on a table, which was wrapped around the display when it was packaged, beneath the screen surface so as not to scratch the screen face.
2. Ensure you have all accessories for mounting this display.
3. Follow the instructions that come with the base mounting kit. Failure to follow correct mounting procedures could result in damage to the equipment or injury to the user or installer. Product warranty does not cover damage caused by improper installation.
4. For the wall-mounting kit, use **M6** mounting screws (**20 mm** long plus the thickness of the mounting bracket) and tighten them securely.

### Caution:

To prevent the display from falling:

- To lessen the probability of injury and damage resulting from fall of the display in case of earthquake or other natural disaster; be sure to consult the bracket manufacturer for installation location.

### Ventilation Requirements for enclosure locating

To allow heat to disperse, leave space between surrounding objects as shown in the diagram below.

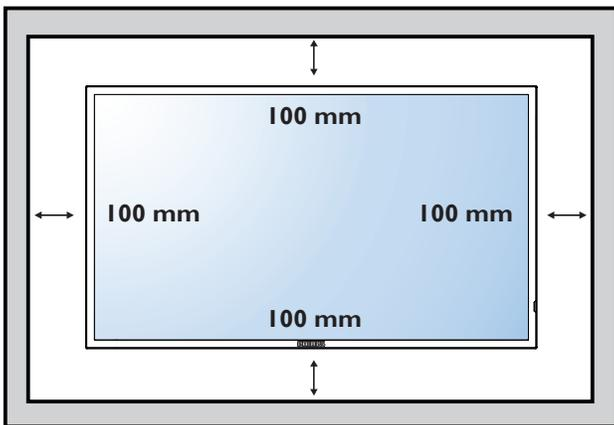

NOTE: When installing the display on a wall, please consult a professional technician for proper installation. We accept no liability for installations not performed by a professional technician.

## 2. Parts and Functions

### 2.1. Control Panel

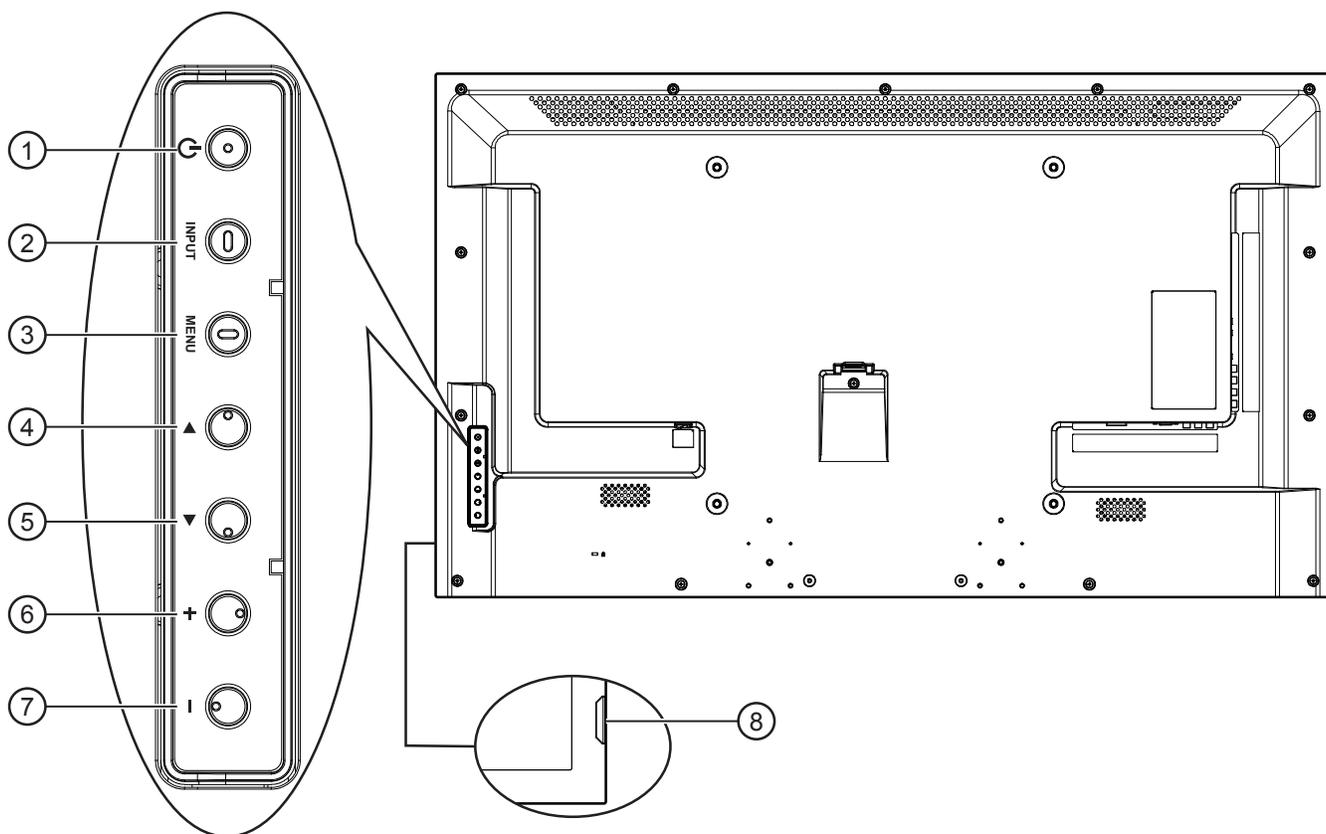

#### ① [POWER] button

Press to switch the display on or off.

#### ② [INPUT] button

Press to select input source.

#### ③ [MENU] button

Press to access the OSD menu.

#### ④ [▲] button

Press to move the highlight bar up to adjust the selected item while OSD menu is on.

#### ⑤ [▼] button

Press to move the highlight bar down to adjust the selected item while OSD menu is on.

#### ⑥ [+] button

Press to increase the adjustment while OSD menu is on, or to increase the audio output level while OSD menu is off.

#### ⑦ [–] button

Press to decrease the adjustment while OSD menu is on, or to decrease the audio output level while OSD menu is off.

#### ⑧ Remote control sensor and power status indicator

- Receives command signals from the remote control.
  - Lights green when this display is turned on
  - Lights red when this display is in standby mode
  - Lights off when the main power of this display is turned off

## 2.2. Input/Output Terminals

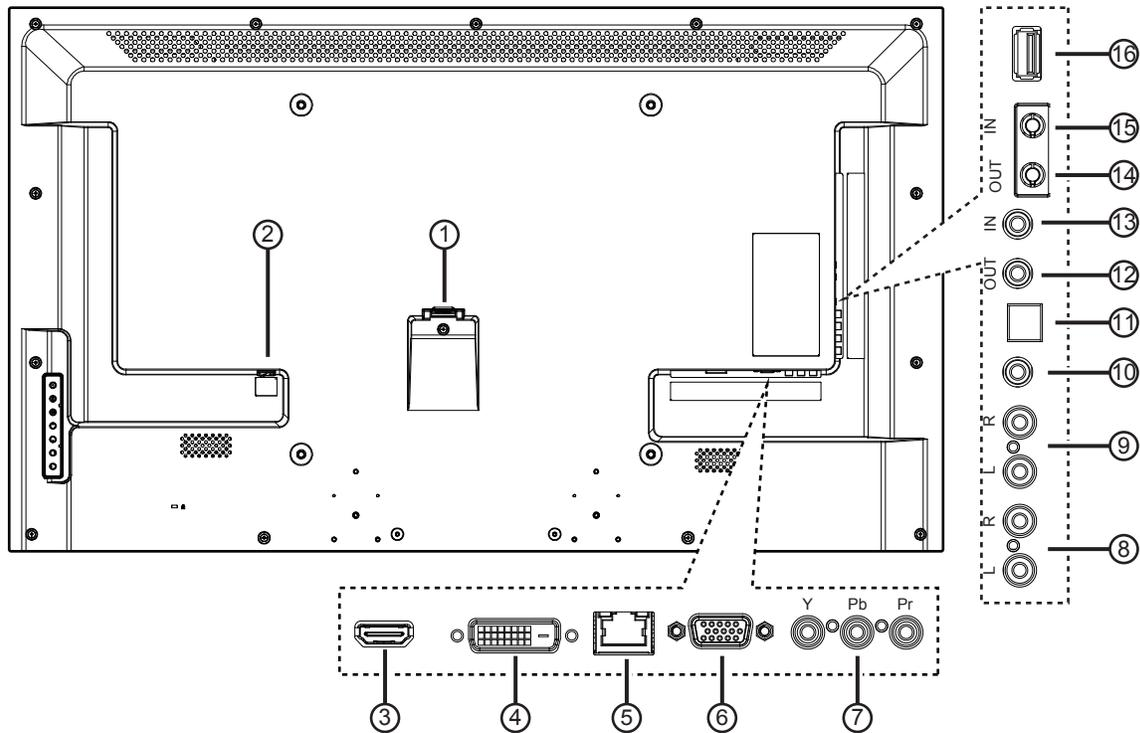

**① AC IN**

AC power input.

**② MAIN POWER SWITCH**

Main power on/off switch.

**③ HDMI IN**

HDMI video/audio input.

**④ DVI IN**

DVI-D video input.

**⑤ RJ-45**

LAN control function for the use of remote control signal from control center.

**⑥ VGA IN (D-Sub)**

VGA video input.

**⑦ COMPONENT IN (RCA)**

Component YPbPr video source input.

**⑧ AUDIO IN (RCA)**

Audio input from external AV device.

**⑨ AUDIO OUT (RCA)**

Audio signal output to connect your external AV device.

**⑩ AUDIO IN (3.5mm)**

Audio input from your PC.

**⑪ SPDIF OUT**

Digital audio signal output to connect your external AV device.

**⑫ IR OUT / ⑬ IR IN (3.5 mm)**

IR signal output/input for the loop-through function.

**NOTES:**

- This display's remote control sensor will stop working if the jack [IR IN] is connected.
- To remotely control your A/V device via this display, refer to page 8 for **IR Pass Through** connection.

**⑭ RS232C OUT / ⑮ RS232C IN (2.5 mm)**

RS232C network output/input for the loop-through function.

**⑯ USB PORT**

Connect your UBS storage device.

## 2.3. Remote Control

### 2.3.1. General functions

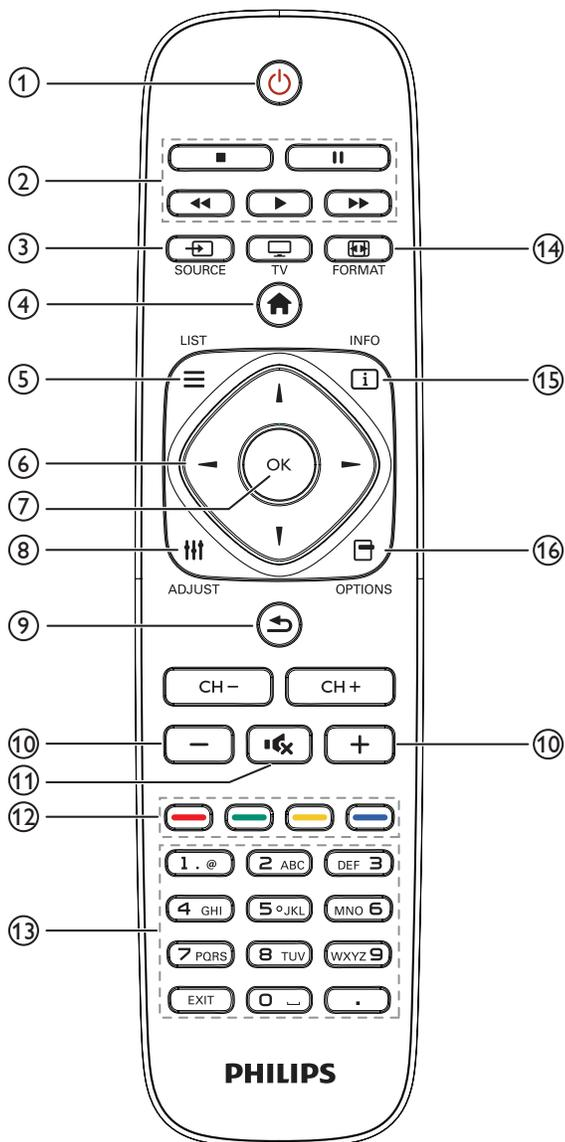

#### 7 OK button

Confirm an entry or selection.

#### 8 ADJUST button

Access currently available options, picture and sound menus.

#### 9 BACK button

Return to the previous menu page or exit from the previous function.

#### 10 - + VOLUME button

Adjust volume.

#### 11 MUTE button

Press to turn the mute function on/off.

#### 12 COLOR buttons

Select tasks or options.

#### 13 NUMERIC buttons

Enter text for network setting.

#### 14 FORMAT button

Change picture format.

#### 15 INFO button

Display information about current activity.

#### 16 OPTIONS

Access currently available options, picture and sound menus.

#### 1 POWER button

Switch this display on or off.

#### 2 PLAY buttons

Control playback of media files.

#### 3 SOURCE button

Select input source. Press [←] or [→] button to select from **USB**, **Network**, **HDMI**, **DVI**, **YPbPr**, **AV**, or **VGA**. Press [OK] button to confirm and exit.

#### 4 HOME button

Access the OSD menu.

#### 5 LIST

No function.

#### 6 NAVIGATION buttons

Navigate through menus and select items.

### 2.3.2. Inserting batteries in the remote control

The remote control is powered by two 1.5V AAA batteries.

To install or replace batteries:

1. Press and then slide the cover to open it.
2. Align the batteries according to the (+) and (-) indications inside the battery compartment.
3. Replace the cover.

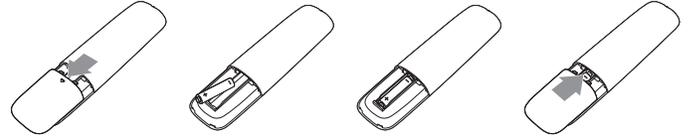

#### Caution:

The incorrect use of batteries can result in leaks or bursting. Be sure to follow these instructions:

- Place "AAA" batteries matching the (+) and (-) signs on each battery to the (+) and (-) signs of the battery compartment.
- Do not mix battery types.
- Do not combine new batteries with used ones. It causes shorter life or leakage of batteries.
- Remove the dead batteries immediately to prevent them from liquid leaking in the battery compartment. Don't touch exposed battery acid, as it can damage your skin.

**NOTE:** If you do not intend to use the remote control for a long period, remove the batteries.

### 2.3.3. Handling the remote control

- Do not subject to strong shock.
- Do not allow water or other liquid to splash the remote control. If the remote control gets wet, wipe it dry immediately.
- Avoid exposure to heat and steam.
- Other than to install the batteries, do not open the remote control.

### 2.3.4. Operating range of the remote control

Point the front of the remote control toward this display's remote control sensor when pressing a button.

Use the remote control within a distance of less than 10m/33ft from this display's sensor, and a horizontal and vertical angle of less than 30 degrees.

**NOTE:** The remote control may not function properly when the remote control sensor on this display is under direct sunlight or strong illumination, or when there is an obstacle in the path of signal transmission.

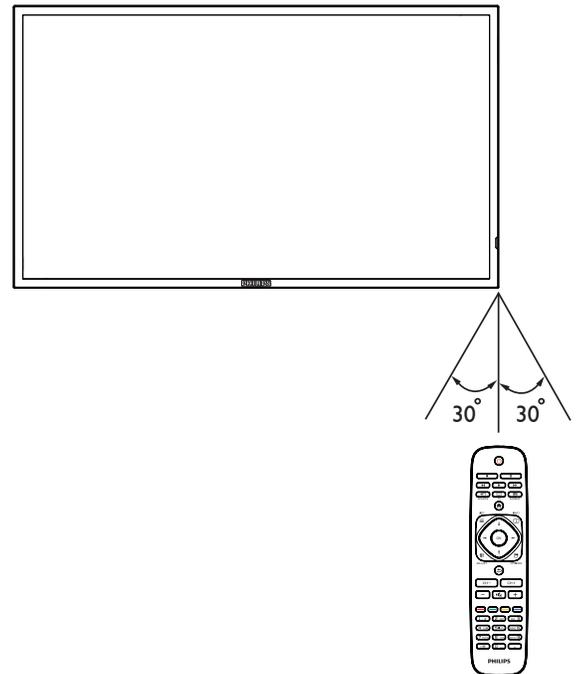

### 3. Connection

NOTE: The peripherals and cables shown are for example purposes only.

#### 3.1. Connecting External Equipments

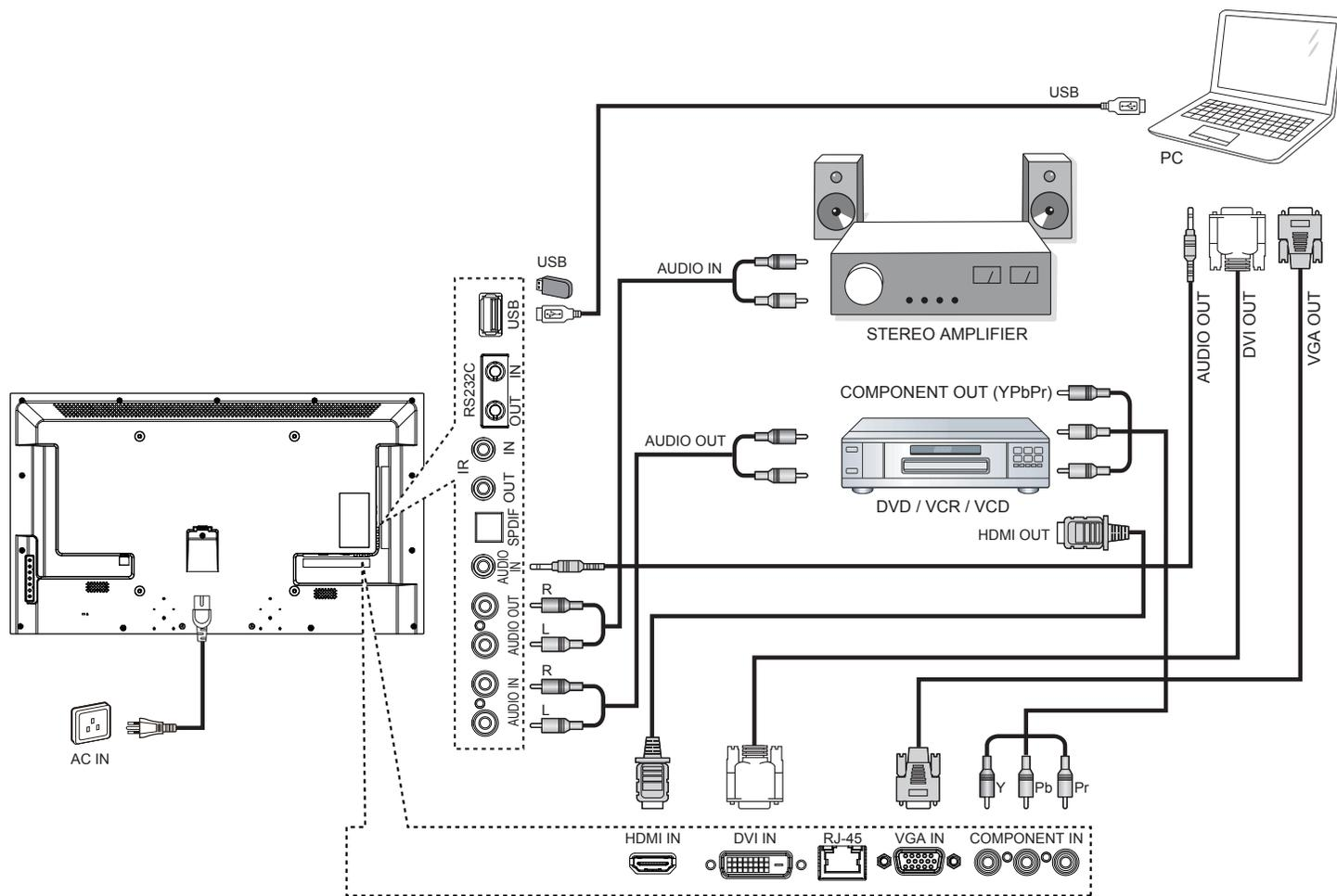

## 3.2. Connecting Multiple Displays

### 3.2.1. RS232C control connection (optional)

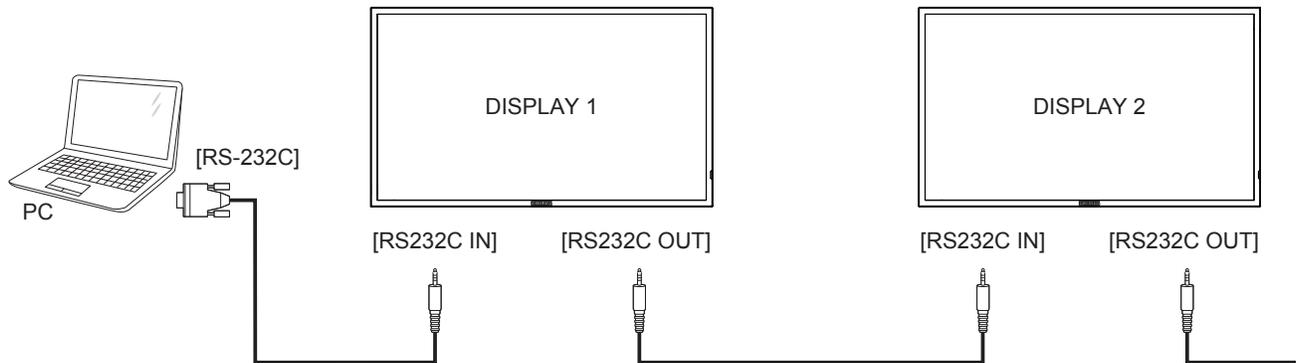

### 3.2.2. IR connection (optional)

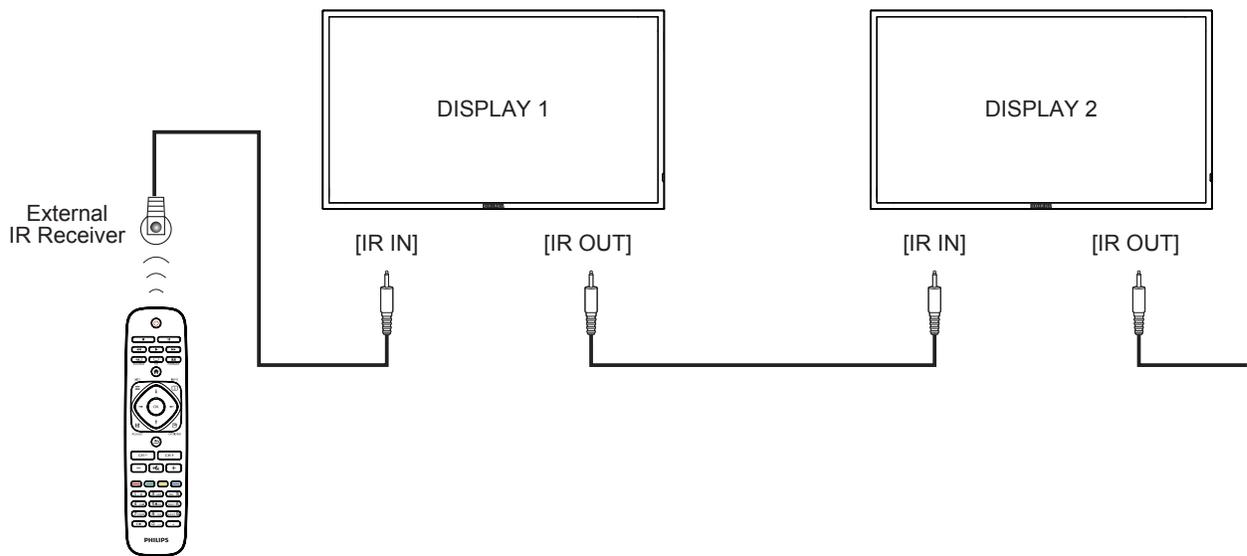

NOTE: This display's remote control sensor will stop working if the [IR IN] is connected.

### 3.3. IR Pass-through Connection (optional)

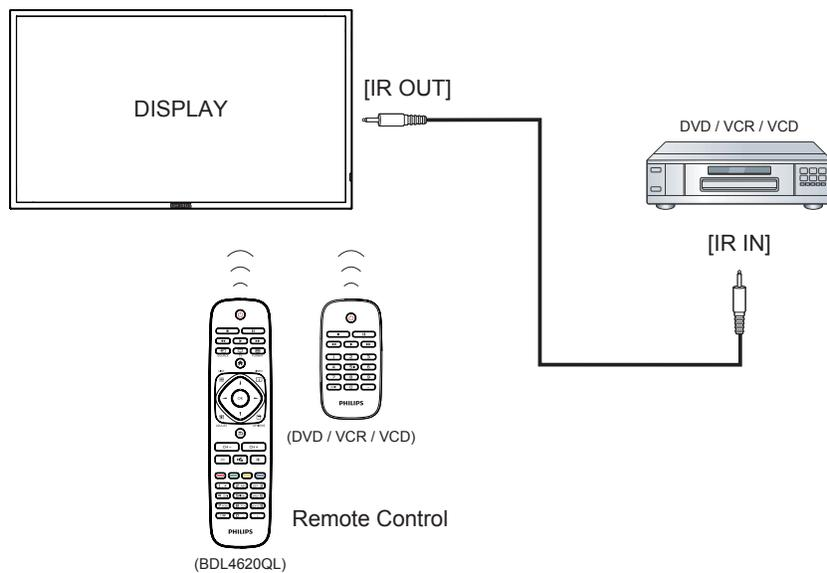



### 3.4. Wire-connecting to Network (optional)

If you connect this display to a home network, you can play photos, music and videos from your computer. See *Play multimedia files* (Page 10) for more detail.

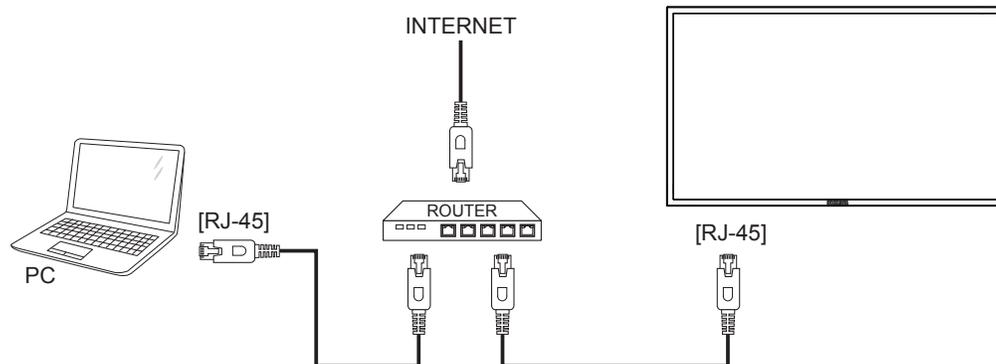

#### To setup the network:

1. Switch on the router and switch on its DHCP setting.
2. Connect the router to this display with an Ethernet cable.
3. Press **Home** button on the remote control, then select **{Setup}**.
4. Select **{Connect to network}**, then press **OK** button.
5. Follow the on-screen instructions to install the network.
6. Wait for this display to find the network connection.
7. If you are prompted, agree to the "End User Licence Agreement".

**NOTE:** Connecting with a shielded CAT-5 Ethernet cable to comply with the EMC directive.

## 4. Operation

**NOTE:** The control button described in this section is mainly on the remote control unless specified otherwise.

### 4.1. Watch the Connected Video Source

See page 7 for external equipments connection.

1. Press  **SOURCE** button.
2. Press  or  button to select a device, then press **OK** button.

### 4.2. Change Picture Format

You can change the picture format to suit the video source. Each video source has its available picture formats.

The available picture formats depend on the video source:

1. Press  **FORMAT** button.
2. Press  or  button to select a picture format, then press **OK** button.
  - **{Auto zoom}**: Enlarge the picture to fill the screen. Recommended for minimal screen distortion but not for **HD** or **PC**.
  - **{Movie expand 16:9}**: Scale 4:3 format to 16:9. Not recommended for **HD** or **PC**.
  - **{Wide screen}**: Shows widescreen format content unstretched. Not recommended for **HD** or **PC**.
  - **{Unscaled}**: Provide maximum detail for **PC**. Only available when **PC** mode is selected in the **{Picture}** menu.
  - **{4:3}**: Display the classic 4:3 format.

### 4.3. Select your Preferred Picture Settings

1. While this display is playing video source, press  **OPTIONS** button.
2. Press  or  button to select **Picture and sound** → **Picture style**, then press **OK** button.
3. Press  or  button to select an option, then press **OK** button:
  - **{Personal}**: Apply your personalised picture settings.
  - **{Vivid}**: Rich and dynamic settings, ideal for daytime viewing.
  - **{Natural}**: Natural picture settings.
  - **{Standard}**: Default settings that suit most environments and types of video.
  - **{Movie}**: Ideal settings for movies.
  - **{Photo}**: Ideal settings for photos.
  - **{Energy saving}**: Settings that conserve the most energy.

### 4.4. Select your Preferred Sound Settings

1. While this display is playing video source, press  **OPTIONS** button.
2. Press  or  button to select **Picture and sound** → **Sound style**, then press **OK** button.
3. Press  or  button to select an option, then press **OK** button:
  - **{Personal}**: Apply your personalised sound settings.
  - **{Original}**: Settings that suit most environments and types of audio.
  - **{Movie}**: Ideal settings for movies.
  - **{Music}**: Ideal settings for listening to music.

- **{Game}**: Ideal settings for games.
- **{News}**: Ideal settings for spoken audio, such as the news.

## 4.5. Play Multimedia Files

You can play videos, photos, and music on your display from:

- Your computer connected through your home network.
- A USB device connected to this display.

### 4.5.1. Play files from computer

To play files from computer, you will need:

- A wired home network, connected with a Universal Plug and Play (uPnP) router.
- Optional: A LAN cable that connects your display to your home network.
- A media server running on your computer.
- Appropriate settings on your computer firewall to allow you to run the media server.

### Set up the network

1. Connect your display and the computer to the same home network. See page 9 for connecting your display to a network.
2. Switch on your computer and the router.

**NOTE:** If the apparatus does not return to DLNA mode due to external electrical disturbances (e.g. electrostatic discharge), user intervention is required.

### Set up media sharing

1. Install a media server on your computer to share media files. These are some media servers:
  - For **PC**: Windows Media Player 11 (or higher) or TVersity
  - For **Mac**: Twonky
2. Switch on media sharing on your computer using the media server. For more information on how to set up the media server, refer to the website of the media server.

### Play files

1. Press  **SOURCE** button.
2. Select **[Browse network]**, then press **OK** button.
3. Select a file from the content browser, then press **OK** button to start playing.
4. Press the **Play buttons** on the remote control to control playing.

### Tips:

- Select the top bar to filter your files by type.
- Select **[Sort]** to arrange the files by album name, artist, or other fields.
- To clear the list of offline media servers, press  **OPTIONS** button, then select **[Clear offline servers]** and press **OK** button.

## 4.5.2. Play multimedia files from USB device

This display can play music, movie, or photo files from your USB device.

1. Connect your USB device to the USB port on this display.

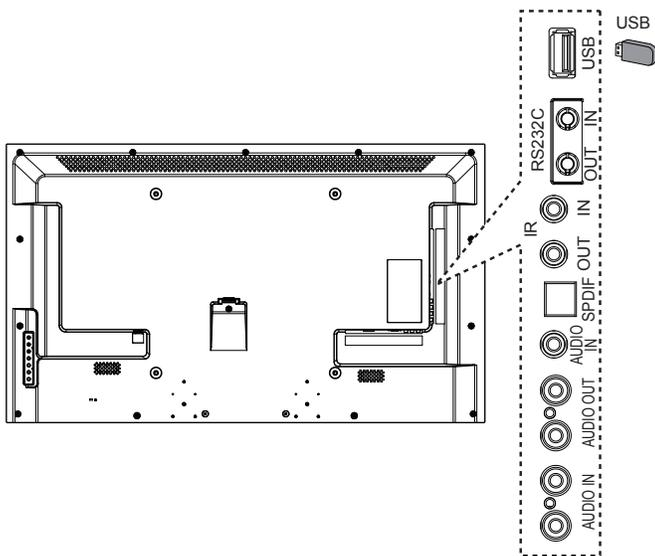

2. Press **SOURCE** button, select **USB**, then press **OK** button.
3. The connected USB device is detected automatically for all its playable files, which will be automatically sorted into 3 types: **Music**, **Movie**, and **Photo**.

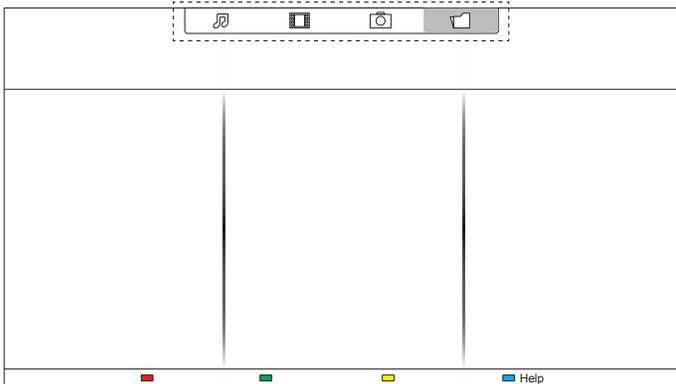

4. Press the **BACK** button to go up to the top layer in the screen. Press **LEFT** or **RIGHT** button to select the file type. Press **OK** button to enter its play list.
5. Select the file you want. Press **OK** button to start playing.
6. Follow the on-screen instruction to control the play option.
7. Press the PLAY buttons (**STOP**, **PAUSE**, **PREVIOUS**, **PLAY**, **NEXT**) to control playing.

### Supported file system:

- FAT32

### Supported file format:

- **Music:** MP3, WMA, M4A, AAC, AC3
- **Movie:** AVI, MP4, MOV, MPG/MPEG
- **Photo:** JPEG, BMP, GIF

### Caution:

- The manufacturer is not responsible if the USB device is not supported, nor is it responsible for damage to or loss of data in the device.

- Do not overload the USB port. If you connect a USB storage device that consumes more than 500mA power, make sure that it is connected to its own external power supply.

## 4.6. Play options

### 4.6.1. Playing music files

1. Select **Music** in the top bar.



2. Select one music track, then press **OK** button.



- To play all the tracks in a folder, select one music file, then select **{Play All}**.
- To skip to the next or previous track, press **CH+** or **VOL-** button.
- To pause the track, press **OK** button. Press **OK** button again to resume playback.
- To skip backward or forward 10 seconds, press **◀** or **▶** button.
- To search backward or forward, press **◀◀** or **▶▶** button, press repeatedly to toggle between different speeds.
- To stop the music, press **■** button.

### Music options

While you play music, press **OPTIONS** button, then press **OK** button to select an option:

- **{Repeat}**: Select **{Repeat}** to play a track or an album repeatedly, or select **{Play once}** to play a track once.
- **{Media Server}**: When you play content from a media server; you can select another media server.
- **{Shuffle On}** / **{Shuffle Off}**: Enable or disable random play of tracks.

**NOTE:** To view information about a song (for example, title, artist or duration), select the song, then press **i INFO** button. To hide the information, press **i INFO** button again.

### 4.6.2. Playing movie files

1. Select **Movie**  in the top bar.



2. Select a video, then press **OK** button.

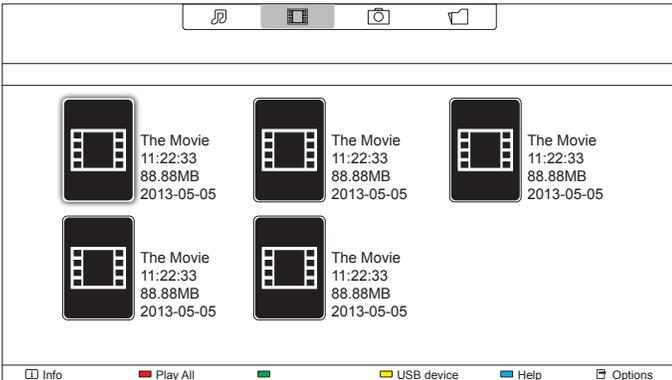

- To play all the videos in a folder, select one video file, then select **{Play All}**.
- To skip to the next or previous video, press **CH+** or **VOL-** button.
- To pause the video, press **OK** button. Press **OK** button again to resume playback.
- To skip backward or forward 10 seconds, press **◀** or **▶** button.
- To search backward or forward, press **◀◀** or **▶▶** button, press repeatedly to toggle between different speeds.
- To stop the video, press **■** button.

#### Movie options

While playing video, press **OPTION** button, then press **OK** button to select an option:

- **{Subtitles}**: Select the available subtitle settings.
- **{Subtitle Language}**: Select the language for subtitles if available.
- **{Character Set}**: Select the correct character set for the subtitles.
- **{Audio Language}**: Select an audio language.
- **{Repeat}**: Select **{Repeat}** to play the video file repeatedly or **{Play once}** to play the video file once.
- **{Media server}**: When you play content from a media server, you can select another media server.
- **{Shuffle On}** / **{Shuffle Off}**: Enable or disable random play of video files.
- **{DivX(R) VOD}**: Display the DivX registration and deregistration codes for this display.

**NOTE:** To view information about a video (for example, played position, duration, title, or date), select the video, then press **i INFO** button. To hide the information, press **i INFO** button again.

### 4.6.3. Playing photo files

1. Select **Photo**  in the top bar.



2. Select a photo thumbnail, then press **OK** button.

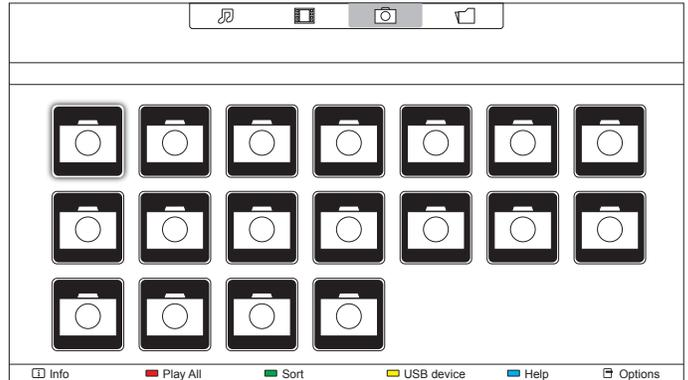

#### Start a slideshow

If there are multiple photos in a folder, select a photo, then select **{Play All}**.

- To skip to the previous or next photo, press **◀** or **▶** button, and then press **OK** button.
- To stop the slideshow, press **■** button.

#### Slideshow options

While you play a slideshow, press **OPTION** button, then press **OK** button to select an option:

- **{Shuffle Off}** / **{Shuffle On}**: Enable or disable random display of pictures in the slideshow.
- **{Repeat}**: Select **{Repeat}** to watch a slideshow repeatedly or **{Play once}** to watch once.
- **{Slideshow Time}**: Select the displaying time for each photo in the slideshow.
- **{Slideshow Transitions}**: Select the transition from one photo to the next.
- **{Media Server}**: When you play content from a media server, you can select another media server.

## 5. Change your settings

### Using the remote control:

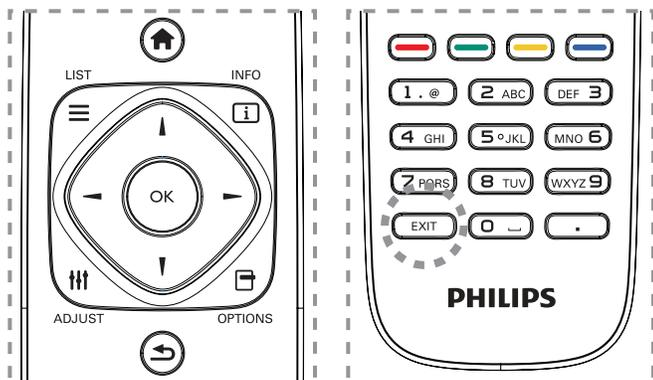

1. Press **HOME** button to display the OSD menu.
2. Press **←**, or **→** button to select {Setup}. Press **OK** button to enter.

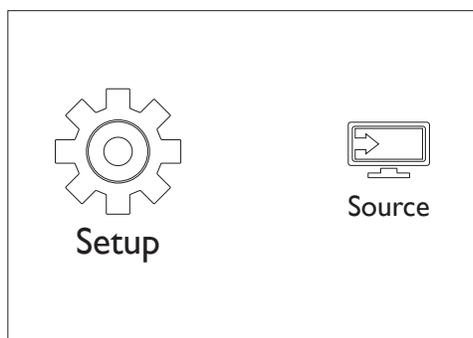

3. Press **▲**, **▼**, **←**, or **→** button to select {Quick picture and sound}, {Settings}, {Connect to network}, or {Network settings}. Press **OK** button to enter.

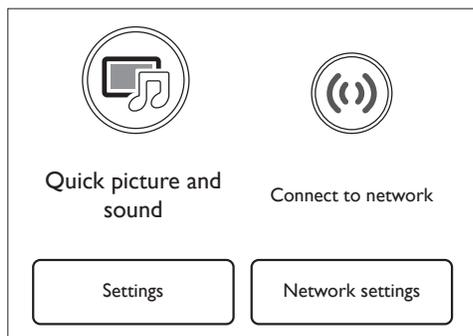

4. Press **▲**, **▼**, **←**, or **→** button to select its menu item or to adjust its value. Press **OK** button to confirm.
5. Press **↶** **BACK** button to go back to the previous menu layer.
6. Press **EXIT** button to exit the OSD menu.

### Using this display's control buttons:

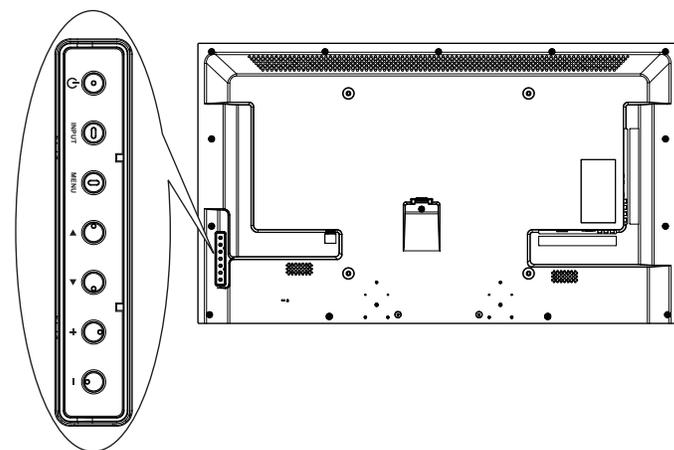

1. Press **MENU** button to display the OSD menu.
2. Press **▲** [**▼**] [**+**] or [**-**] button to select menu item or adjust its value.
3. Press **INPUT** button to confirm menu selection and enter its submenu.
4. Press **MENU** button to exit the OSD menu.

### 5.1. Quick Picture and Sound

You can select picture and sound settings with the help of the settings assistant, which demonstrates the effect of your chosen setting immediately.

1. Press **HOME** button to display the OSD menu.
2. Select {Setup}. Press **OK** button.
3. Select {Quick picture and sound}. Press **OK** button.
4. Select {Continue}, then press **OK** button
5. Follow the on-screen instructions to choose your preferred settings.

### 5.2. Settings

#### 5.2.1. Picture menu

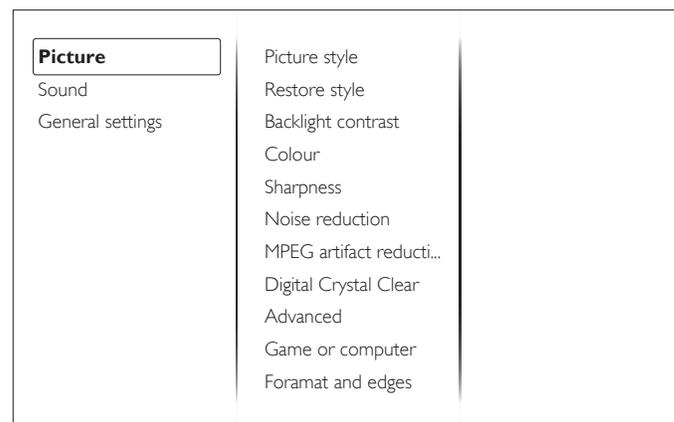

#### Picture style

Select a predefined picture setting.

#### Restore style

Restore the last-selected predefined picture setting.

**Backlight contrast**

Adjust the brightness of this display's backlight.

**Colour**

Adjust the colour saturation of the picture.

**Sharpness**

Adjust the sharpness of the picture.

**Noise reduction**

Select the amount of noise reduction for the picture.

**MPEG artifact reduction**

Smoothen transitions and haziness in the digital picture.

**Digital Crystal Clear**

Fine-tune each pixel to match surrounding pixels and produce a brilliant, high-definition image.

- **{Advanced sharpness}**: Enable superior sharpness, especially on lines and contours in the picture.
- **{Dynamic contrast}**: Dynamically enhance the details in the dark, medium and light areas of the picture.
- **{Dynamic backlight}**: Select a backlight level to optimise dynamic power consumption and picture contrast.
- **{Colour enhancement}**: Dynamically enhance the vividness and details of colours.

**Advanced**

Access advanced settings such as gamma, tint settings and video contrast settings.

- **{Gamma}**: Adjust the non-linear setting for picture luminance and contrast.
- **{Tint}**: Change the colour balance.
- **{Custom tint}**: Customise colour balance setting. Only available if **{Tint}** → **{Custom}** is selected.
- **{Video contrast}**: Adjust video contrast.
- **{Brightness}**: Adjust screen brightness.

**Game or computer**

When viewing content from a connected game console, select **{Game}** to apply game settings. When a computer is connected through HDMI, select **{Computer}**.

Make sure that **{Format and edges}** → **{Picture format}** → **{Unscaled}** is selected so as to view maximum detail.

**Format and edges**

Access advanced settings to control the displaying format of the picture.

- **{Picture format}**: Change the picture format.
- **{Screen edges}**: Change the picture size.
- **{Picture shift}**: If available, move the position of the picture.

**5.2.2. Sound menu****Sound style**

Access predefined sound settings.

**Restore style**

Restore the last-selected predefined sound setting.

**Bass**

Adjust the bass level of the speaker and headphones.

**Treble**

Adjust the treble level of the speaker and headphones.

**Surround mode**

Select a surround sound mode to enhance your audio experience.

**Audio out**

Adjust audio output volume.

**Advanced**

Access advanced settings to enhance your audio experience.

- **{Auto volume leveling}**: Enable the reduction of sudden volume changes.
- **{Speaker settings}**: Turn on or off the internal speakers.
- **{Clear sound}**: Enhance sound quality.
- **{Audio out format}**: Select the type of audio output through the digital audio output connector.
- **{Audio out leveling}**: Set the output level for stereo audio. Select **{Less}** for a certain amount of loss in intensity or signal strength. Select **{More}** for no loss in intensity or signal strength.
- **{Audio out delay}**: Automatically sync the image on this display to the audio from a connected home theatre.
- **{Audio out offset}**: Adjust the setting for audio output delay. Available if **{Audio out delay}** is switched on.

### 5.2.3. General settings menu

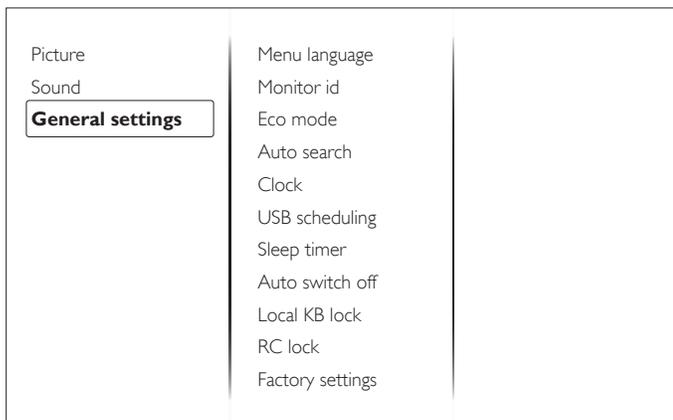

#### Menu language

Select language used for OSD menus.

#### Monitor id

Set the ID number for controlling this display via the RS232C connection. Each display must have a unique ID number when multiple sets of this display are connected.

#### Eco mode

Set this display to reduce the power consumption automatically.

#### Auto search

Choose to let this display detect and display available signal sources automatically.

#### Clock

Adjust clock settings.

#### USB scheduling

This function allows you to program up to 3 different scheduled time intervals for this display to activate, and auto play USB media file of your setting.

After changing the {Clock} option in the {General settings} menu, you need to set this {USB scheduling} again.

#### Sleep timer

Switch off this display after a specified time.

#### Auto switch off

Set the time for this display to be switched off after a period of no activity. Press any key on the remote control to disable this function.

#### Local KB lock

Choose to enable or disable the keyboard (control buttons) function of this display.

- {Unlock}: Enable the keyboard function.
- {Lock all}: Lock all keyboard function.
- {Lock but volume}: Disable all the keyboard function except the **VOL+** and **VOL-** button.
- {Lock but power}: Disable all the keyboard function except the **POWER** button.

#### RC lock

Choose to enable or disable the button function of the remote control.

- {Unlock}: Enable the button function.
- {Lock all}: Lock all button function.

- {Lock but volume}: Disable all the button function except the **+** **VOLUME** button.
- {Lock but power}: Disable all the button function except the **POWER** button.

**NOTE:** To disable the lock function from [Local KB lock] or [RC lock] item, press buttons **HOME 1 9 9 8** on the remote control.

#### Factory settings

Reset all your customized settings to the factory defaults.

## 5.3. Network Settings

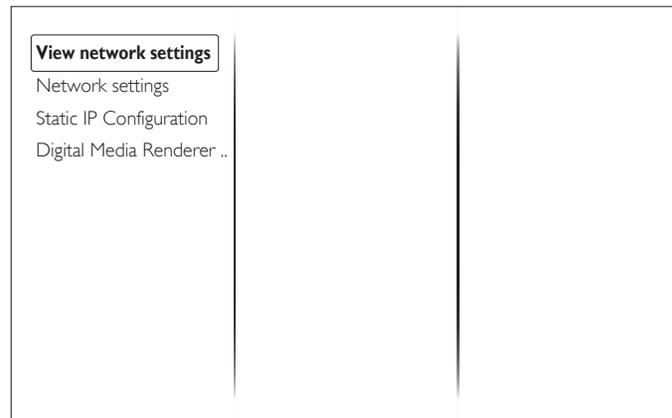

#### View network settings

View connected network status.

#### Network settings

Select how this display should assign addresses to the network resources.

#### Static IP Configuration

Assign {IP address}, {Netmask}, {Gateway}, {DNS1}, and {DNS2} for this display.

#### Digital Media Renderer - DMR

Receive multimedia files from Smart Phones or Tablets connected to your network.

## 6. Input mode

### PC Resolution:

Standard Resolution	Active Resolution		Refresh Rate	Pixel Rate	Aspect Ratio	Stand for Mode
	H Pixels	V Lines				
VGA	640	480	60 Hz	25.175 MHz	4:3	Video Graphic Array
		480	72 Hz	31.5 MHz		
		480	75 Hz	31.5 MHz		
WVGA	720	400	70 Hz	33.75 MHz	16:9	Wide Video Graphic Array
SVGA	800	600	60 Hz	40 MHz	4:3	Super VGA
		600	75 Hz	49.5 MHz		
XGA	1024	768	60 Hz	65 MHz	4:3	Extended Graphic Array
		768	75 Hz	78.75 MHz		
WXGA	1280	768	60 Hz	79.5 MHz	5:3	Wide XGA
WXGA	1280	800	60 Hz	79.5 MHz	16:10	Wide XGA
SXGA	1280	1024	60 Hz	108 MHz	5:4	Super XGA
WXGA	1360	768	60 Hz	85.5 MHz	16:9	Wide XGA
UXGA	1600	1200	60 Hz	162 MHz	4:3	Ultra XGA
HD1080	1920	1080	60 Hz	148.5 MHz	16:9	HD1080

### SDTV Resolution:

Standard Resolution	Active Resolution		Refresh Rate	Pixel Rate	Aspect Ratio	Stand for Mode
	H Pixels	V Lines				
480i	720	480	29.97 Hz	13.5 MHz	4:3	Modified NTSC Standard
480p			59.94 Hz	27 MHz		
576i	720	480	25 Hz	13.5 MHz	4:3	Modified PAL Standard
576p			50 Hz	27 MHz		

### HDTV Resolution:

Standard Resolution	Active Resolution		Refresh Rate	Pixel Rate	Aspect Ratio	Stand for Mode
	H Pixels	V Lines				
720p	1280	720	50 Hz	74.25 MHz	16:9	Normally DVB Mode
			60 Hz			
1080i	1920	1080	25 Hz	74.25 MHz	16:9	Normally ATSC Mode
			30 Hz			
1080p	1920	1080	50 Hz	148.5 MHz	16:9	Normally ATSC Mode
			60 Hz			

- The PC text quality is optimum in HD 1080 mode (1920 × 1080, 60 Hz).
- Your PC display screen might appear different depending on the manufacturer (and your particular version of Windows).
- Check your PC instruction book for information about connecting your PC to a display.
- If a vertical and horizontal frequency-select mode exists, select 60 Hz (vertical) and 31.5 KHz (horizontal). In some cases, abnormal signals (such as stripes) might appear on the screen when the PC power is turned off (or if the PC is disconnected). If so, press the **[INPUT]** button to enter the video mode. Also, make sure that the PC is connected.
- When horizontal synchronous signals seem irregular in RGB mode, check PC power saving mode or cable connections.
- This display settings table complies to the IBM/VESA standards, and based on the analog input.
- The DVI support mode is regarded as same to the PC support mode.
- The best timing for the vertical frequency to each mode is 60 Hz.



## 7. Pixel Defect Policy

We strive to deliver the highest quality products and use some of the industry's most advanced manufacturing processes whilst practicing stringent quality control. However, pixel or sub-pixel defects on the PDP / TFT panels used in Plasma- & LCD- displays are sometimes unavoidable. No manufacturer can guarantee that all panels will be free from pixel defects, but Philips guarantees that any Plasma- & LCD- displays with an unacceptable number of defects will be repaired during the warranty period in line with your local guarantee conditions.

This notice explains the different types of pixel defects and defines the acceptable defect level for the LCD screen. In order to qualify for repair under warranty, the number of pixel defects must exceed a certain level as shown in the reference table. If the LCD screen is within specification a warranty exchange / claim back will be refused. Additionally, because some types or combinations of pixel defects are more noticeable than others, Philips sets even higher quality standards for those.

### 7.1. Pixels and Sub-pixels

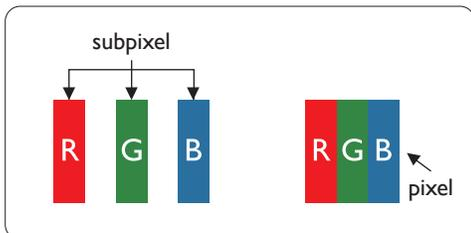

A pixel, or picture element, is composed of three sub-pixels in the primary colors of red, green and blue. Many pixels together form an image. When all sub-pixels of a pixel are lit, the three colored sub-pixels together appear as a single white pixel. When all are dark, the three colored sub-pixels together appear as a single black pixel. Other combinations of lit and dark sub-pixels appear as single pixels of other colors.

### 7.2. Types of Pixel Defects + Dot Definition

Pixel and sub-pixel defects appear on the screen in different ways. There are three categories of pixel defects and several types of sub-pixel defects within each category.

#### Dot definition = What is a defective "Dot"?

One or more defective, adjacent sub-pixel are defined as one "dot". The no. of defective sub-pixels are not relevant to define a defective dot. This means that a defective dot can consist of one, two or three defective sub-pixels which can be dark or lit.

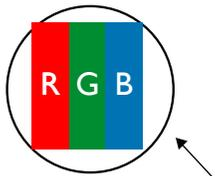

One dot = One Pixel; consists of three sub-pixels of Red, Green, and Blue.

### 7.3. Bright Dot Defects

Bright dot defects appear as pixels or sub-pixels that are always lit or "on". These are the examples of bright dot defects:

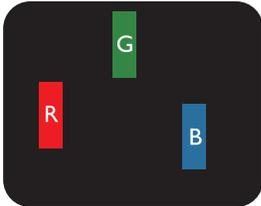
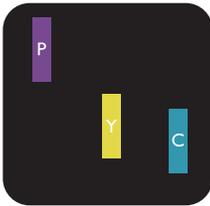
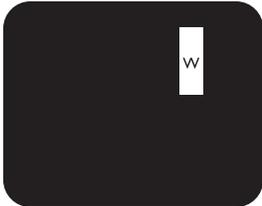
 <p>One lit red, green or blue sub pixel</p>	 <p>Two adjacent lit sub pixels: Red + Blue = Purple Red + Green = Yellow Green + Blue = Cyan (Light Blue)</p>	 <p>Three adjacent lit sub pixels (one white pixel)</p>
---	---	--

## 7.4. Dark Dot Defects

Black dot defects appear as pixels or sub-pixels that are always dark or "off". These are the examples of black dot defects:

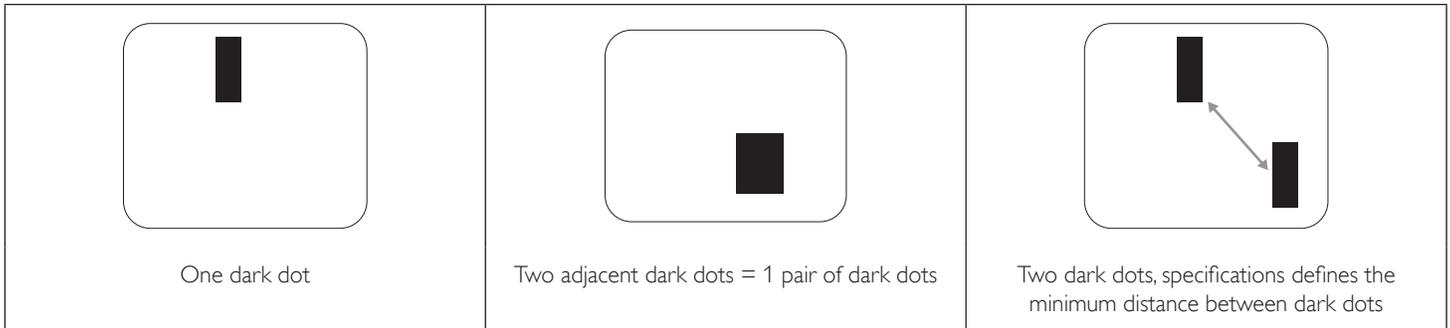

## 7.5. Proximity of Pixel Defects

Because pixel and sub-pixels defects of the same type that are nearby one another may be more noticeable, Philips also specifies tolerances for the proximity of pixel defects. In the table below you can find specifications about:

- Allowed amount of adjacent dark dots = (adjacent dark dots = 1 pair of dark dots)
- Minimum distance between dark dots
- Total no. of all defective dots

## 7.6. Pixel Defect Tolerances

In order to qualify for repair due to pixel defects during the warranty period, a PDP / TFT panel in a Philips Plasma / LCD- display must have pixel or sub-pixel defects exceeding the tolerances listed in the following table.

BRIGHT DOT EFFECT	ACCEPTABLE LEVEL
1 lit sub pixel	2
BLACK DOT EFFECT	ACCEPTABLE LEVEL
1 dark sub pixel	10
TOTAL DOT DEFECTS OF ALL TYPES	12

NOTE: \* 1 or 2 adjacent sub pixel defects = 1 dot defect

## 7.7. MURA

Dark spots or patches may occasionally appear on some liquid crystal display (LCD) panels. This is known within the industry as Mura, which is a Japanese term for "unevenness." It is used to describe an irregular pattern or area in which uneven screen uniformity appears under certain conditions. Mura is a result of the deterioration of the liquid crystal alignment layer and is most commonly caused by long-term operation under high ambient temperatures. It is an industry- wide phenomenon and Mura is not repairable. It is also not covered by our warranty terms.

Mura has been around since the introduction of LCD technology and with screens getting bigger and in operation 24/7, many displays are running in low light conditions. This all adds to the possibility of Mura affecting displays.

### HOW TO SPOT MURA

There are many symptoms of Mura and also multiple causes. Several of these are listed below:

- Impurities or foreign particles in the crystal matrix
- Uneven distribution of LCD matrix during manufacturing
- Non-uniform luminance distribution of the backlight
- Panel assembly induced stress
- Flaws within the LCD cells
- Thermal induced stress – high temperature operation over long periods of time

### HOW TO AVOID MURA

Although we can not guarantee the complete eradication of Mura every time, in general the appearance of Mura can be minimized by these methods:

- Lower the backlight brightness
- Use a screen saver
- Reduce the ambient temperature around the unit

---

## 8. Cleaning and Troubleshooting

### 8.1. Cleaning

#### Caution When Using the Display

- Do not bring your hands, face or objects close to the ventilation holes of the display. The top of the display is usually very hot due to the high temperature of exhaust air being released through the ventilation holes. Burns or personal injuries may occur if any body parts are brought too close. Placing any object near the top of the display could also result in heat related damage to the object as well as the display itself.
- Be sure to disconnect all cables before moving the display. Moving the display with its cables attached may damage the cables and thus cause fire or electric shock.
- Disconnect the power plug from the wall outlet as a safety precaution before carrying out any type of cleaning or maintenance procedure.

#### Front Panel Cleaning Instructions

- The front of the display has been specially treated. Wipe the surface gently using only a cleaning cloth or a soft, lint-free cloth.
- If the surface becomes dirty, soak a soft, lint-free cloth in a mild detergent solution. Wring the cloth to remove excess liquid. Wipe the surface of the display to remove dirt. Then use a dry cloth of the same type to dry.
- Do not scratch or hit the surface of the panel with fingers or hard objects of any kind.
- Do not use volatile substances such as insect sprays, solvents and thinners.

#### Cabinet Cleaning Instructions

- If the cabinet becomes dirty, wipe the cabinet with a soft, dry cloth.
- If the cabinet is extremely dirty, soak a lint-free cloth in a mild detergent solution. Wring the cloth to remove as much moisture as possible. Wipe the cabinet. Use another dry cloth to wipe over until the surface is dry.
- Do not allow any water or detergent to come into contact with the surface of the display. If water or moisture gets inside the unit, operating problems, electrical and shock hazards may result.
- Do not scratch or hit the cabinet with fingers or hard objects of any kind.
- Do not use volatile substances such as insect sprays, solvents and thinners on the cabinet.
- Do not place anything made from rubber or PVC near the cabinet for any extended periods of time.

## 8.2. Troubleshooting

Symptom	Possible Cause	Remedy
No picture is displayed	<ol style="list-style-type: none"> <li>1. The power cord is disconnected.</li> <li>2. The main power switch on the back of the display is not switched on.</li> <li>3. The selected input has no connection.</li> <li>4. The display is in standby mode.</li> </ol>	<ol style="list-style-type: none"> <li>1. Plug in the power cord.</li> <li>2. Make sure the power switch is switched on.</li> <li>3. Connect a signal connection to the display.</li> </ol>
Interference displayed on the display or audible noise is heard	Caused by surrounding electrical appliances or fluorescent lights.	Move the display to another location to see if the interference is reduced.
Color is abnormal	The signal cable is not connected properly.	Make sure that the signal cable is attached firmly to the back of the display.
Picture is distorted with abnormal patterns	<ol style="list-style-type: none"> <li>1. The signal cable is not connected properly.</li> <li>2. The input signal is beyond the capabilities of the display.</li> </ol>	<ol style="list-style-type: none"> <li>1. Make sure that the signal cable is attached firmly.</li> <li>2. Check the video signal source to see if it is beyond the range of the display. Please verify its specifications with this display's specification section.</li> </ol>
Display image doesn't fill up the full size of the screen	The zoom mode is not correctly set.	Use the Zoom mode or Custom zoom function in the Screen menu to fine tune display geometry and time frequency parameter.
Can hear sound, but no picture	Improperly connected source signal cable.	Make sure that both video inputs and sound inputs are correctly connected.
Can see picture but no sound is heard	<ol style="list-style-type: none"> <li>1. Improperly connected source signal cable.</li> <li>2. Volume is turned all the way down.</li> <li>3. [MUTE] is turned on.</li> <li>4. No external speaker connected.</li> </ol>	<ol style="list-style-type: none"> <li>1. Make sure that both video inputs and sound inputs are correctly connected.</li> <li>2. Press [—] or [+ ] button to hear sound.</li> <li>3. Switch MUTE off by using the  [MUTE] button.</li> <li>4. Connect external speakers and adjust the volume to a suitable level.</li> </ol>
Some picture elements do not light up	Some pixels of the display may not turn on.	This display is manufactured using an extremely high level of precision technology; however, sometimes some pixels of the display may not display. This is not a malfunction.
After-Images can still be seen on the display after the display is powered off. (Examples of still pictures include logos, video games, computer images, and images displayed in 4:3 normal mode)	A still picture is displayed for an over extended period of time	Do not allow a still image to be displayed for an extended period of time as this can cause a permanent after-image to remain on the display.

## 9. Technical Specifications

### Display:

Item	Specifications
Screen Size (Active Area)	46" LCD (116.8 cm)
Aspect Ratio	16:9
Number of Pixels	1920 (H) × 1080 (V)
Pixel Pitch	0.53025 (H) × 0.53025 (V) [mm]
Displayable Colors	16.7 Million colors
Brightness	350 cd/m <sup>2</sup>
Contrast Ratio (Typical)	3000:1
Viewing Angle	178 degrees

### In/Out Terminals:

Item	Specifications
Speaker Output	Internal Speakers 7W (L) + 7W (R) [RMS]/16Ω, 1 Way 1 Speaker System 82 dB/W/M/160 Hz ~ 13 KHz
Audio Output	RCA Jack × 2 0.5V [rms] (Normal) / 2 Channel (L+R)
Audio Input	3.5 mm Stereo × 1 RCA Jack × 2 0.5V [rms] (Normal) / 2 Channel (L+R)
RS232C Input/Output	2.5 mm × 2 TXD + RXD (1:1)
LAN	RJ-45 Jack × 1 (8 pin) 10/100 LAN Port
HDMI Input	HDMI Jack × 1 (Type A) (19 pin) Digital RGB: TMDS (Video + Audio) MAX: Video: 720p, 1080p, 1920 × 1080/60 Hz (WUXGA) Audio: 48 KHz / 2 Channel (L+R) Supports LPCM only
DVI-D Input	DVI-D jack Digital RGB: TMDS (Video)
VGA Input	D-Sub Jack × 1 (15 pin) Analog RGB: 0.7V [p-p] (75Ω), H/CS/V: TTL (2.2kΩ), SOG: 1V [p-p] (75Ω) MAX: 720p, 1080p, 1920 × 1080/60 Hz (WUXGA)
Component Input	RCA Jack × 3 Y: 1V [p-p] (75Ω), Pb: 0.7V [p-p] (75Ω), Pr: 0.7V [p-p] (75Ω) MAX: 480i, 576i, 480p, 576p, 720p, 1080i, 1080p
SPDIF Output	SPDIF Port Serial digital audio output when input is HDMI
IR Input/Output	3.5 mm × 2 IR pass through or IR daisy chain
USB Input	USB × 1 (Type B) USB 2.0, External PC connection

### General:

Item	Specifications
Power Input	100-240V $\sim$ 50-60Hz, 2.5A
Power Consumption (Max.)	95 W
Power Consumption (Typical)	80 W
Power Consumption (EPA6.0)	60 W
Power Consumption (Standby & Off)	< 0.5W (OSD: APM mode off)
Dimensions [W × H × D]	1068 × 622.5 × 38.8 mm
Weight	13.7 Kg
Gross Weight	17.2 Kg

### Environmental Condition:

Item	Specifications	
Temperature	Operational	5 ~ 40°C
	Storage	-20 ~ 60°C
Humidity	Operational	20 ~ 80% RH (No condensation)
	Storage	10 ~ 90% RH (No condensation)
Altitude	Operational	0 ~ 2,000 m
	Storage	0 ~ 5,000 m

