



Quick Installation Guide

Full HD Mini Fixed Dome Network Camera

This document will guide you through the basic installation process for your new D-Link Network Camera.

DCS-6210

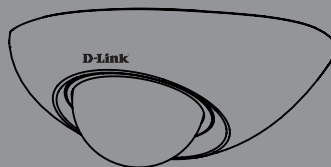

Quick Installation Guide
Installationsanleitung
Guide d'installation
Guía de instalación
Guida di Installazione

Documentation also available on CD
and via the D-Link Website



DCS-6210 Quick Install Guide

This installation guide provides basic instructions for installing the DCS-6210 Network Camera on your network. For additional information about how to use the camera, please see the User's Manual which is available on the CD included in this package or from the D-Link support website.

Installation Steps

1. Verify the package contents against the list below.
2. Hardware Overview
3. SD Card Installation
4. Hardware Installation
5. Configuration with Wizard
6. Adjusting the lens 3-axis angel

1. Package Contents

- DCS-6210 Network camera
- Manual and Software on CD-ROM
- Quick Installation Guide
- Power Adaptor
- CAT-5 Ethernet cable
- Screwdriver and Screws for installation
- Alignment Sticker
- Rubbers

If any of the above items are missing, please contact your reseller.

Safety Notice:

Installation and servicing should be done by certified technicians so as to conform to all local codes and prevent voiding your warranty.

2. Hardware Overview

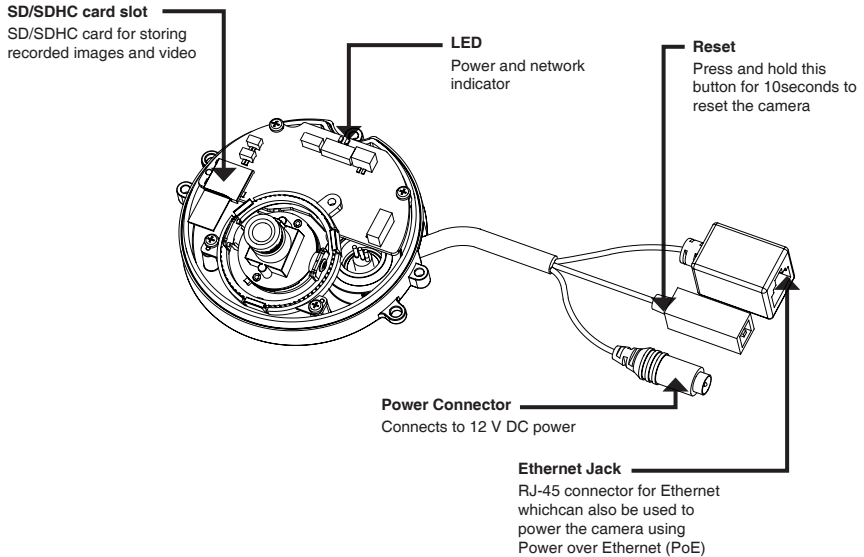

3. SD Card Installation

Disassemble the Camera

Open the camera enclosure by loosen the 3 screws. Lift the dome off the base of the camera.

Install the SD Card

Push the SD card into the camera with the gold contacts oriented towards the base of the camera. To eject the SD card, push the SD card into the slot.

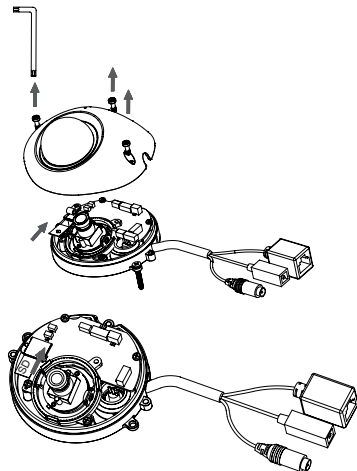

4. Hardware Installation

Mounting Installation

Please see the User Manual for detailed instructions regarding installation and mounting of the camera.

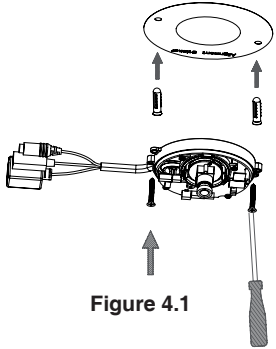

Figure 4.1

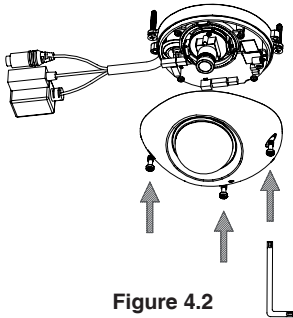

Figure 4.2

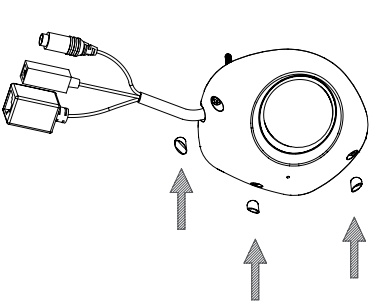

Figure 4.3

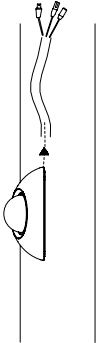

Figure 4.4

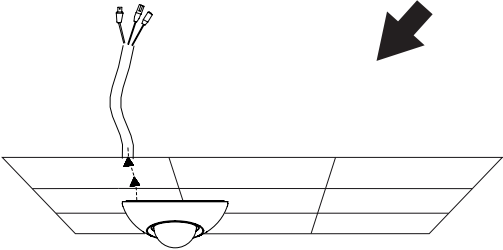
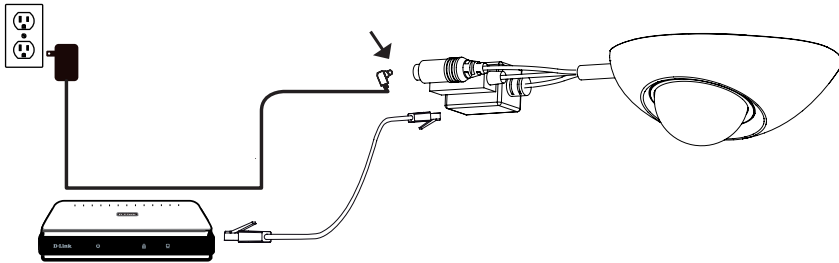

Figure 4.5

General Connection Using 12 V DC Power Adapter

1. Connect the network camera to a hub via an Ethernet cable.
2. Connect the supplied power cable from the camera to a power outlet.

**Connection with a PoE Hub**

If you are using a PoE hub, connect the IP camera to the hub via an Ethernet cable, which will provide transmission of both power and data over a single cable.

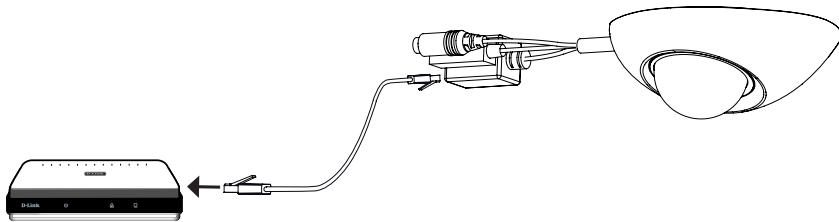

5. Configuration with Wizard

Insert the DCS-6210 CD into your computer's CD-ROM drive to begin the installation. If the Autorun function on your computer is disabled, or if the D-Link Launcher fails to start automatically, click **Start > Run**. Type **D:\autorun.exe**, where D: represents the drive letter of your CD-ROM drive.

Click **Setup Wizard** to begin the installation.

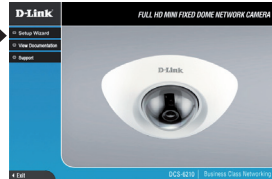

After clicking Setup Wizard, the following window will open.

Click **Next** to continue.

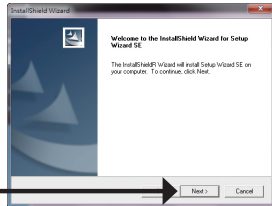

Click **Yes** to accept the License Agreement.

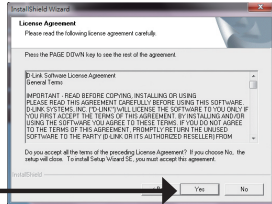

To start the installation process, click **Next**.

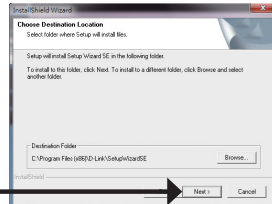

Note: The installation may take several minutes to finish.

Click **Finish** to complete the installation.

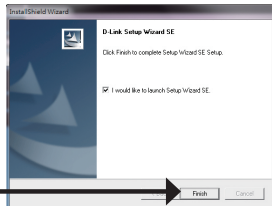

Click on the **D-Link Setup Wizard SE** icon that was created in your Windows Start menu.

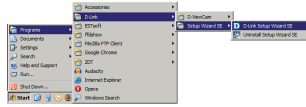

Start > D-Link > Setup Wizard SE

The Setup Wizard will appear and display the MAC address and IP address of your camera(s). If you have a DHCP server on your network, a valid IP Address will be displayed. If your network does not use a DHCP server, the network camera's default static IP **192.168.0.20** will be displayed.

Click the **Wizard** button to continue.



Enter the Admin ID and password. When logging in for the first time, the default Admin ID is **admin** with the password left blank.

Click **Next**, to proceed to the next page.

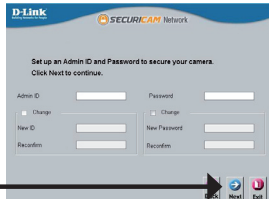

Select DHCP if your camera obtains an IP address automatically when it boots up. Select static IP if the camera will use the same IP address each time it is started.

Click **Next**, to proceed to the next page.



Take a moment to confirm your settings and click **Restart**.

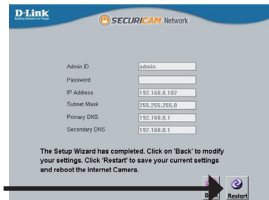

Viewing Camera via Web Browser

Click on the **D-Link Setup Wizard SE** icon that was created in your Windows Start menu.

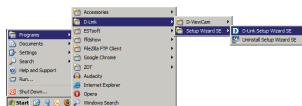

Start > D-Link > Setup Wizard SE

Select the camera and click the button labeled **"Link"** to access the web configuration.

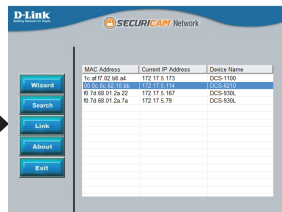

The Setup Wizard will automatically open your web browser to the IP address of the camera.

Enter **admin** as the default username and leave the password blank. Click **OK** to continue.

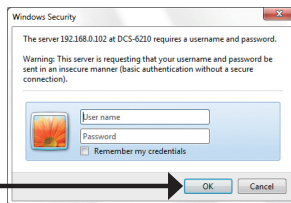

This section shows your camera's live video. You can select your video profile and view or operate the camera. For additional information about web configuration, please refer to the user manual included on the CD-ROM or the D-Link website.



6. Adjusting the lens 3-axis angel

Adjust the Viewing Angle of the 3-axis Mechanism

Turn the lens module left and right until the desired position is achieved.

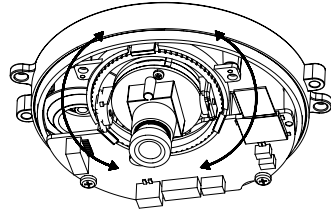

Turn the lens up and down until the desired position is achieved.

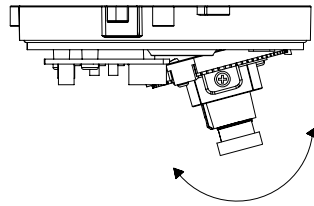

Turn the lens to adjust the IP camera's image until the desired orientation is achieved.

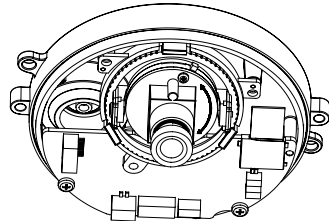

TECHNICAL SUPPORT

United Kingdom (Mon-Fri) website: <http://www.dlink.co.uk> FTP: <ftp://ftp.dlink.co.uk>
Home Wireless/Broadband 0871 873 3000 (9.00am–06.00pm, Sat 10.00am–02.00pm)
Managed, Smart, & Wireless Switches, or Firewalls 0871 873 0909 (09.00am- 05.30pm)
(BT 10ppm, other carriers may vary.)

Ireland (Mon-Fri)

All Products 1890 886 899 (09.00am–06.00pm, Sat 10.00am–02.00pm)
Phone rates: €0.05ppm peak, €0.045ppm off peak times

NOTES

DCS-6210 Installationsanleitung

Diese Installationsanleitung bietet Ihnen grundlegende Anleitungen zur Installation der DCS-6210 Netzwerkkamera in Ihrem Netzwerk. Zusätzliche Informationen zur Verwendung der Kamera finden Sie im Benutzerhandbuch, das Ihnen auf der CD, die diesem Paket beiliegt, oder über die D-Link Support-Website zur Verfügung steht.

Installationsschritte

1. Prüfen Sie den Packungsinhalt, ob er mit den auf der Liste unten aufgeführten Artikeln übereinstimmt.
2. Hardware-Überblick
3. SD-Karteninstallation
4. Hardware-Installation
5. Konfiguration mithilfe des Assistenten
6. 3-Achsenwinkel des Objektivs einstellen

1. Packungsinhalt

- DCS-6210 Netzwerkkamera
- Handbuch und Software auf der CD-ROM
- Schnellinstallationsanleitung
- Netzteil
- CAT-5 Ethernet-Kabel
- Schraubenzieher und Schrauben für die Installation
- Klebeschablone
- Radierer

Sollte einer der oben aufgeführten Artikel fehlen, wenden Sie sich bitte an Ihren Fachhändler.

Sicherheitshinweis:

Installation und Wartungsarbeiten sollten nur von zertifizierten Technikern vorgenommen werden, zu jeder Zeit allen örtlich geltenden Richtlinien und Anforderungen entsprechen sowie verhindern, dass Ihr Garantiesanspruch erlischt.

2. Hardware-Überblick

SD/SDHC-Karteneinschub

SD/SDHC-Karte zum Speichern von Bildern und Videoaufnahmen

LED

Strom- und Netzwerkanzeige

Zurücksetzen

Drücken und halten Sie diese Taste 10 Sekunden lang, um die Kameraeinstellungen zurückzusetzen

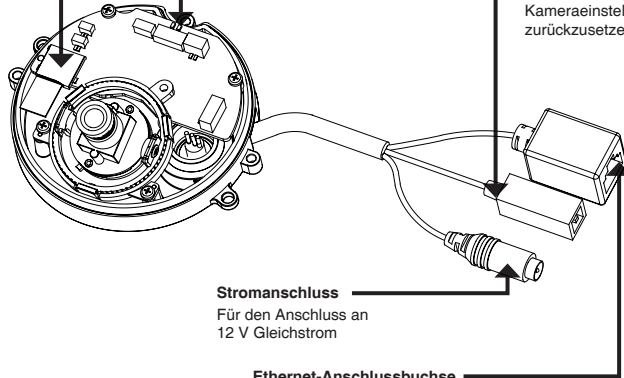

Stromanschluss

Für den Anschluss an 12 V Gleichstrom

Ethernet-Anschlussbuchse

RJ-45-Anschluss für Ethernet, der auch für die Stromzufuhr (PoE/Power over Ethernet) der Kamera verwendet werden kann

DEUTSCH

3. SD-Karteninstallation

Vorbereitende Demontage der Kamera

Öffnen Sie das Kameragehäuse, indem Sie die 3 Schrauben lösen. Nehmen Sie den Dom vom Sockel der Kamera.

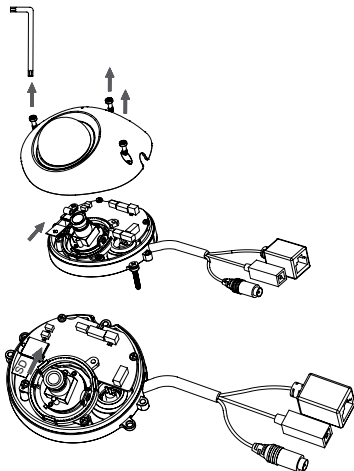

Installation der SD-Karte

Stecken Sie die SD-Karte in die Kamera. Achten Sie darauf, dass die goldfarbenen Kontakte auf den Kamerafuß zeigen. Um die SD-Karte auszuwerfen, drücken Sie sie leicht in den Steckplatz.

4. Hardware-Installation

Montage und Installation

Genauere Anleitungen zur Installation und Montage der Kamera mithilfe eines Befestigungsbügels finden Sie im Benutzerhandbuch.

DEUTSCH



Abbildung 4.1



Abbildung 4.2

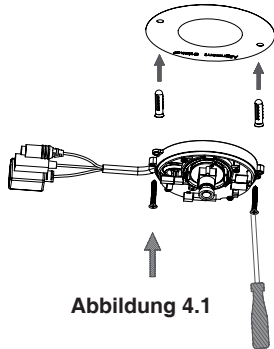

Abbildung 4.3

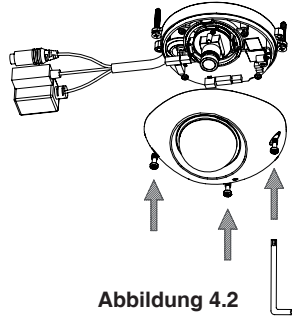

Abbildung 4.4

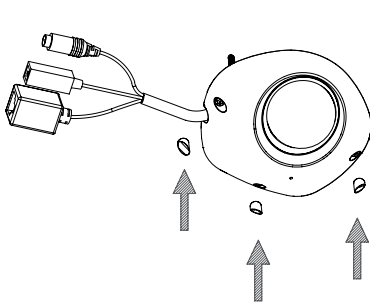

Abbildung 4.5

Allgemeiner Anschluss mit 12 V Gleichstrom-Netzteil/Stromadapter

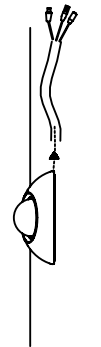
1. Schließen Sie die Netzwerkkamera mit dem Ethernetkabel an einen Hub an.
2. Schließen Sie die Kamera mit dem mitgelieferten Stromkabel an eine Steckdose an.

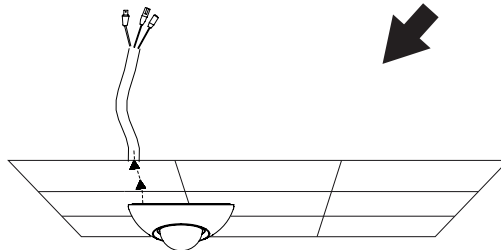
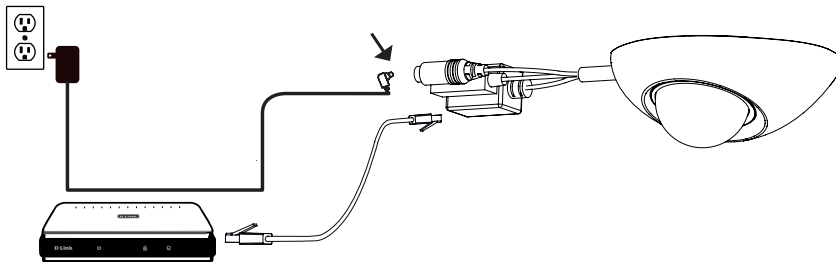

DEUTSCH

Anschluss an einen PoE-Hub

Wenn Sie einen PoE-Hub verwenden, schließen Sie die IP-Kamera mit dem Ethernetkabel an den Hub an, so dass Strom und Daten über ein einziges Kabel übertragen werden.

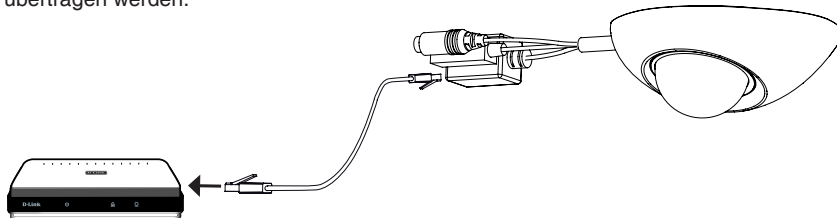

5. Konfiguration mithilfe des Assistenten

Legen Sie die DCS-6210 CD in das CD-ROM-Laufwerk Ihres Computers, um die Installation zu beginnen. Sollte die CD auf Ihrem Computer nicht automatisch ausgeführt werden oder der D-Link Launcher startet nicht automatisch, klicken Sie auf **Start > Ausführen**. Geben Sie **D:\autorun.exe** ein, wobei D: für den Laufwerkbuchstaben Ihres CD-ROM-Laufwerks steht.

DEUTSCH

Klicken Sie auf **Setup Wizard** (Setup-Assistent), um die Installation zu beginnen.



Nachdem Sie auf 'Setup Wizard' (Setup-Assistent) geklickt haben, wird das folgende Fenster geöffnet.

Klicken Sie auf **Next**(Weiter), um fortzufahren.

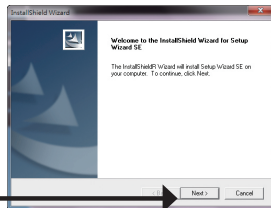

Klicken Sie auf **Yes** (Ja), um die Lizenzvereinbarung zu akzeptieren.

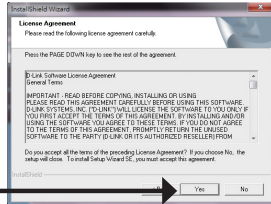

Um den Installationsprozess zu starten, klicken Sie auf **Next** (Weiter).

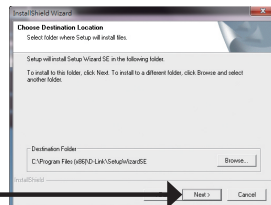

Hinweis: Der Installationsvorgang kann mehrere Minuten dauern.

Klicken Sie auf **Finish** (Fertig stellen), um die Installation abzuschließen.

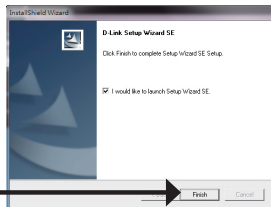

Klicken Sie auf das Symbol für den **D-Link SE Setup-Assistenten**, der in Ihrem Windows-Startmenü erstellt wurde.

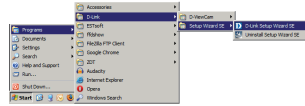

Start > D-Link > Setup Wizard SE

Der Setup-Assistent wird aufgerufen und zeigt die MAC- und IP-Adresse Ihrer Kamera(s) an. Wenn in Ihrem Netzwerk ein DHCP-Server vorhanden ist, wird eine gültige IP-Adresse angezeigt. Weist Ihr Netzwerk keinen DHCP-Server auf, wird die standardmäßige statische IP-Adresse **192.168.0.20** der Netzwerkkamera angezeigt.

Klicken Sie auf **Wizard** (Assistent), um fortzufahren.



Geben Sie die Administratorkennung und das Kennwort ein. Bei Erstanmeldung ist die standardmäßige Administratorkennung **admin**. Das Feld <password> (Kennwort) bleibt leer.



Klicken Sie auf **Next** (Weiter), um die nächste Seite anzuzeigen.



Wählen Sie DHCP, wenn Ihrer Kamera bei Systemstart automatisch eine IP-Adresse zugewiesen wird. Wählen Sie statische IP, wenn die Kamera bei jedem Neustart die gleiche IP-Adresse verwendet.

Klicken Sie auf **Next** (Weiter), um die nächste Seite anzuzeigen.

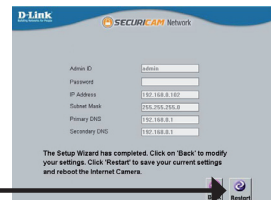

Prüfen Sie Ihre Einstellungen und klicken Sie dann auf **Restart** (Neustart).

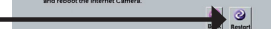

Anzeige der Kamera über einen Webbrowser

Klicken Sie auf das Symbol für den **D-Link SE Setup-Assistenten**, der in Ihrem Windows-Startmenü erstellt wurde.

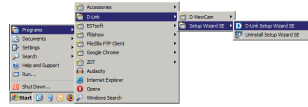

DEUTSCH

Start > D-Link > Setup Wizard SE

Wählen Sie die Kamera aus und klicken Sie auf die Schaltfläche **Link**, um auf die Web-Konfiguration zuzugreifen.

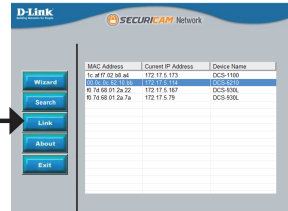

Der Setup-Assistent öffnet automatisch Ihren Webbrowser mit der IP-Adresse der Kamera.

Geben Sie als Standard-Benutzernamen **admin** ein und lassen Sie das Feld 'Password' (Kennwort) leer. Klicken Sie auf **OK**, um fortzufahren.



In diesem Abschnitt werden Live Videoaufnahmen Ihrer Kamera angezeigt. Sie können Ihr Videoprofil auswählen und die Kamera anzeigen und bedienen. Weitere Informationen zur Web-Konfiguration finden Sie in dem auf der CD-ROM enthaltenen Benutzerhandbuch oder auf der D-Link-Website.



6. 3-Achsenwinkel-Objektiv einstellen

Einstellen des Sichtwinkels des 3-Achsenmechanismus

Drehen Sie das Objektivmodul so weit nach links bzw. rechts, bis die gewünschte Position erreicht ist.

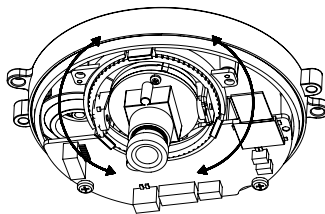

DEUTSCH

Bewegen Sie das Objektivmodul nach oben bzw. unten, bis die gewünschte Position eingestellt ist.

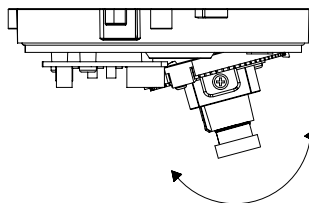

Drehen Sie das Objektiv zur Einstellung des Bildes der IP-Kamera bis die gewünschte Ausrichtung erreicht ist.

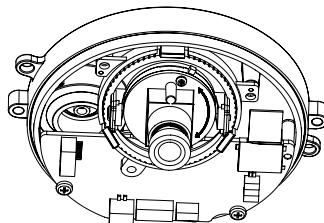

TECHNISCHE UNTERSTÜTZUNG

Deutschland: Web: <http://www.dlink.de>

Telefon: +49(0)1805 2787 0,14 € pro Minute Zeiten: Mo. –Fr. 09:00 – 17:30 Uhr

Österreich: Web: <http://www.dlink.at>

Telefon: +43(0)820 480084 0,116 € pro Minute Zeiten: Mo. –Fr. 09:00 – 17:30 Uhr

Schweiz: Web: <http://www.dlink.ch>

Telefon: +41(0)848 331100 0,08 CHF pro Minute Zeiten: Mo. –Fr. 09:00 – 17:30 Uhr

* Gebühren aus Mobilnetzen und von anderen Providern können abweichen.

NOTES

Guide d'installation rapide - DCS-6210

Ce guide d'installation fournit des instructions élémentaires qui vous aideront à installer la caméra réseau DCS-6210 sur votre réseau. Pour obtenir des informations complémentaires sur l'utilisation de la caméra, consultez le Manuel d'utilisation, disponible sur le CD joint à ce coffret, ou sur le site de support en ligne D-Link.

Procédure d'installation

1. Vérifiez le contenu de la boîte par rapport à la liste ci-dessous.
2. Description du matériel
3. Installation de la carte SD
4. Installation du matériel
5. Configuration à l'aide de l'assistant
6. Réglage de l'angle de lentille à 3 axes

1. Contenu de la boîte

- Caméra réseau DCS-6210
- Manuel et logiciel sur CD-ROM
- Guide d'installation rapide
- Adaptateur d'alimentation
- Câble Ethernet CAT-5
- Tournevis et vis pour l'installation
- Autocollant d'alignement
- Caoutchoucs

Contactez votre revendeur s'il manque l'un des éléments ci-dessus.

Remarque de sécurité :

L'installation et l'entretien doivent être réalisés par des techniciens qualifiés afin d'être conformes à tous les codes locaux et d'éviter d'annuler votre garantie.

2. Description du matériel

Fente pour carte SD/SDHC

Carte SD/SDHC pour stocker des images et vidéos enregistrées

LED

Indicateur d'alimentation et réseau

Réinitialisation

Appuyez sur ce bouton pendant 10 secondes pour réinitialiser la caméra

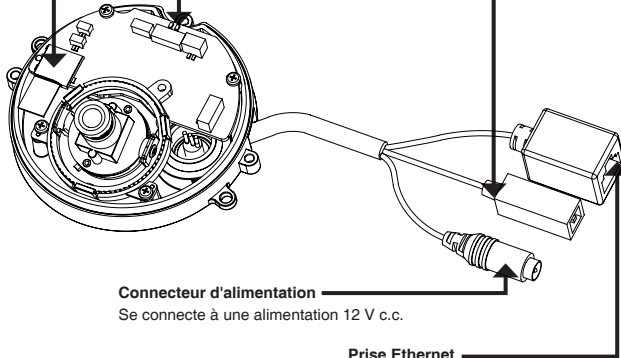

Connecteur d'alimentation

Se connecte à une alimentation 12 V c.c.

Prise Ethernet

Connecteur RJ-45 pour Ethernet, pouvant aussi servir à alimenter la caméra selon la méthode PoE

3. Installation de la carte SD

Démontage de la caméra

Ouvrez le boîtier de la caméra en desserrant les 3 vis. Soulevez le dôme pour le retirer de la base de la caméra.

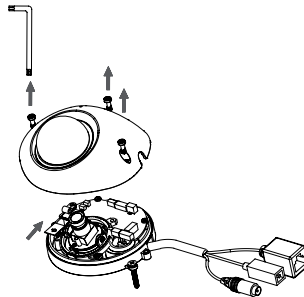

Installer la carte SD

Insérez la carte SD dans la caméra avec les contacts dorés orientés vers la base de la caméra. Pour éjecter la carte SD, appuyez dessus dans le port.

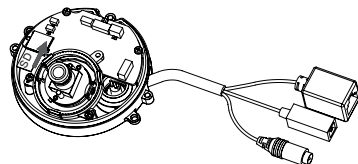

4. Installation du matériel

Installation de montage

Veillez consulter le manuel d'utilisation pour obtenir des instructions détaillées concernant l'installation et l'assemblage de la caméra en utilisant un support de fixation.

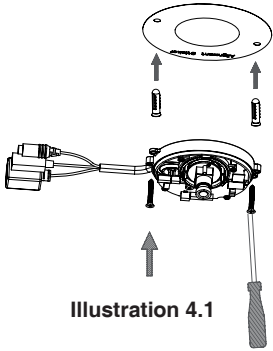

Illustration 4.1

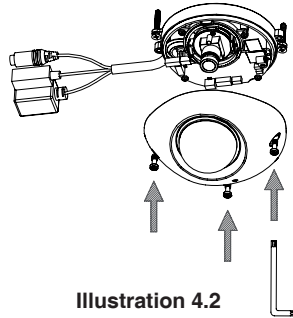

Illustration 4.2

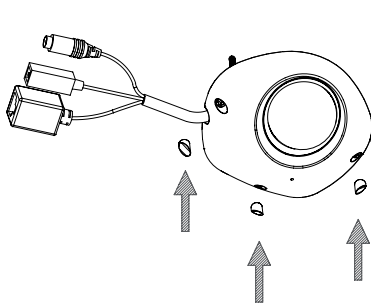

Illustration 4.3

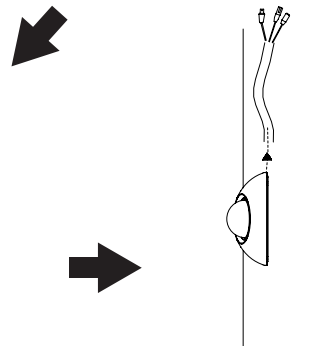

Illustration 4.4

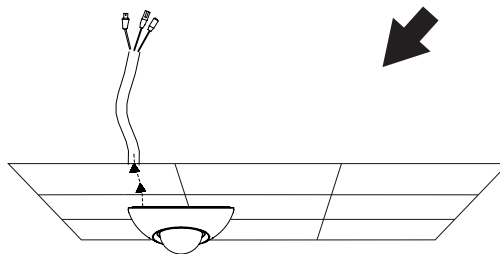
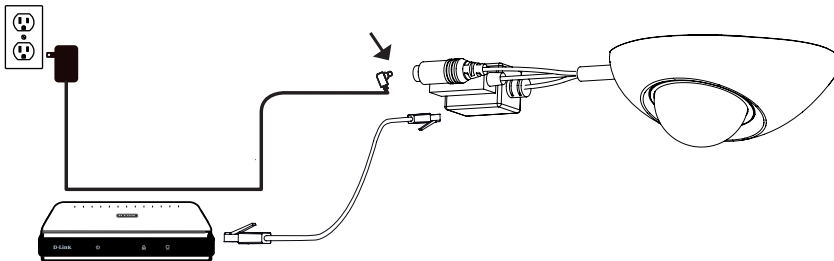

Illustration 4.5

FRANÇAIS

Connexion générale utilisant un adaptateur électrique (CC 12 V)

1. Connectez la caméra réseau à un concentrateur par l'intermédiaire du câble Ethernet.
2. Branchez le câble d'alimentation fourni à la caméra et à une prise secteur.



FRANÇAIS

Connexion avec un concentrateur Ethernet PoE

Si vous utilisez un concentrateur Ethernet PoE pour alimenter la caméra, connectez celle-ci au concentrateur à l'aide du câble Ethernet fourni, qui sert à la fois de câble pour l'alimentation et les données.

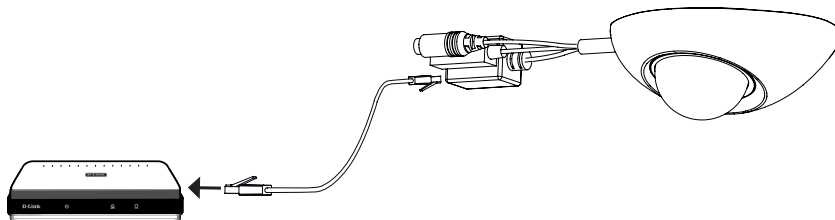

5. Configuration à l'aide de l'assistant

Insérez le CD de la DCS-6210 dans le lecteur de CD-ROM de l'ordinateur pour lancer l'installation. Si la fonction d'exécution automatique de votre ordinateur est désactivée ou si le dispositif de lancement D-Link ne parvient pas à démarrer automatiquement, cliquez sur **Démarrer > Exécuter**. Saisissez **D:\autorun.exe** (où D: représentant la lettre de lecteur de votre CD-ROM).

Cliquez sur **Setup Wizard** (Assistant de configuration) pour lancer l'installation.



Après avoir cliqué sur l'Assistant de configuration, la fenêtre suivante s'ouvre.

Cliquez sur **Next** (Suivant) pour continuer.

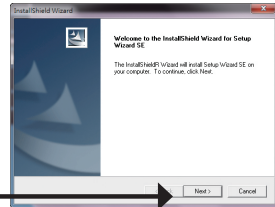

Cliquez sur **Yes (Oui)** pour accepter le **License Agreement** (Accord de licence).

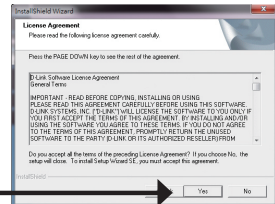

Pour lancer l'installation, cliquez sur **Next** (Suivant).

Remarque : L'installation peut prendre quelques minutes.

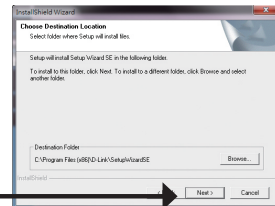

Cliquez sur **Finish** (Terminer) pour terminer l'installation.

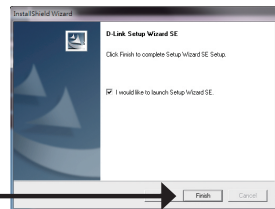

FRANÇAIS

Cliquez sur l'icône **D-Link Setup Wizard SE (Assistant de configuration D-Link SE)** créée dans le menu Démarrer.

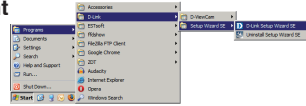

Démarrer > D-Link > Setup Wizard SE (Assistant de configuration SE)

L'Assistant de configuration s'ouvre et affiche les adresses MAC et IP de votre ou vos caméras. Si un serveur DHCP se trouve sur votre réseau, une adresse IP valide s'affiche. Si votre réseau n'utilise pas de serveur DHCP, l'adresse IP statique par défaut de la caméra réseau (**192.168.0.20**) s'affiche.

Cliquez sur **Wizard** (Assistant) pour continuer.



Saisissez l'ID admin et le mot de passe. Lorsque vous vous connectez pour la première fois, l'ID Admin par défaut est **admin** et le mot de passe est vierge.

Cliquez sur **Next** (Suivant) pour passer à la page suivante.

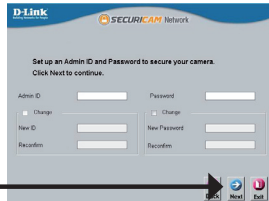

Sélectionnez DHCP si la caméra obtient une adresse IP automatiquement au démarrage. Sélectionnez Static IP (Adresse IP statique) si la caméra utilise la même adresse IP à chaque démarrage.

Cliquez sur **Next** (Suivant) pour passer à la page suivante.

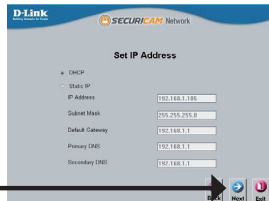

Prenez le temps de vérifier vos paramètres, puis cliquez sur **Restart** (Redémarrer).

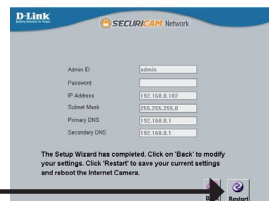

Affichage de la caméra dans un navigateur Web

Cliquez sur l'icône **D-Link Setup Wizard SE (Assistant de configuration D-Link SE)** créée dans le menu Démarrer.

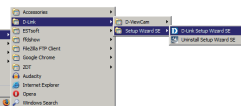

Démarrer > D-Link > Setup Wizard SE (Assistant de configuration SE)

Sélectionnez la caméra, puis cliquez sur le bouton « **Link** » (Connexion) pour accéder à la configuration Web.



L'Assistant de configuration ouvre automatiquement votre navigateur Web à l'adresse IP de la caméra.

FRANÇAIS

Saisissez **admin** comme nom d'utilisateur par défaut et laissez le mot de passe vide. Cliquez sur **OK** pour continuer.



Cette section présente la vidéo en direct de votre caméra. Vous pouvez sélectionner votre profil vidéo et voir ou utiliser la caméra. Pour obtenir des informations complémentaires sur la configuration Web, reportez-vous au manuel d'utilisation du CD-ROM ou sur le site Web D-Link.

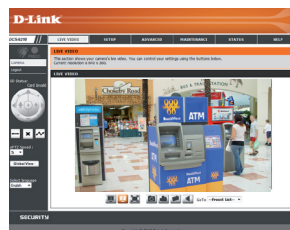

6. Réglage de l'angle de lentille à 3 axes

Réglez l'angle de vue en jouant sur le mécanisme à 3 axes.

Tournez le module d'objectif vers la gauche et la droite jusqu'à obtention de la position souhaitée.

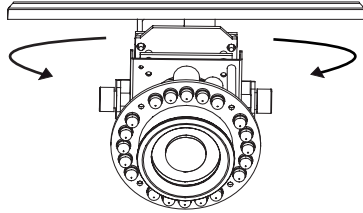

Inclinez l'objectif vers le haut et vers le bas jusqu'à obtention de la position souhaitée.

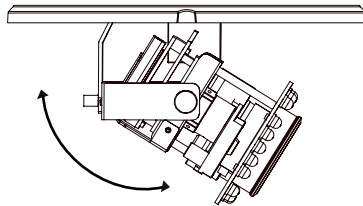

Tournez l'objectif pour régler l'image de la caméra IP jusqu'à obtention de l'orientation souhaitée.

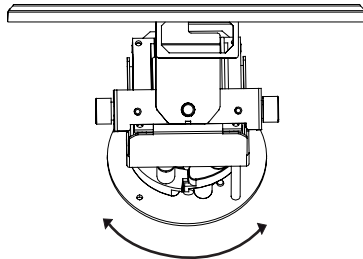

FRANÇAIS

ASSISTANCE TECHNIQUE

Assistance technique D-Link sur internet : <http://www.dlink.fr>

Assistance technique D-Link par téléphone : 01 76 54 84 17

Du lundi au vendredi de 9h à 19h (hors jours fériés)

NOTES

Guía de instalación rápida de DCS-6210

Esta guía de instalación proporciona instrucciones básicas para la instalación de la cámara de red DCS-6210 en su red. Para obtener información adicional acerca de cómo utilizar la cámara, consulte el Manual del usuario disponible en el CD incluido en el paquete o en el sitio web de asistencia de D-Link.

Pasos para la instalación

1. Verifique el contenido de la caja con la lista que aparece a continuación.
2. Descripción general del hardware
3. Instalación de tarjeta SD
4. Instalación del hardware
5. Configuración con el asistente
6. Ajuste del ángulo de los 3 ejes de la lente

1. ¿Qué contiene la caja?

- Cámara de red DCS-6210
- Manual y software en CD-ROM
- Guía de instalación rápida
- Adaptador de alimentación
- Cable Ethernet CAT-5
- Destornillador y tornillos para la instalación
- Pegatina de alineación
- Gomas de protección

Si falta cualquiera de los componentes anteriores, póngase en contacto con el proveedor.

Aviso de seguridad:

La instalación y el mantenimiento deben realizarlo técnicos cualificados con el fin de cumplir con todos los códigos locales y evitar la anulación de la garantía.

2. Descripción general del hardware

Bahía para tarjeta SD/SDHC

Tarjeta SD/SDHC para almacenar imágenes grabadas y vídeo

LED

Indicador de alimentación y de red

Reiniciar

Pulse y mantenga pulsado este botón durante 10 segundos para

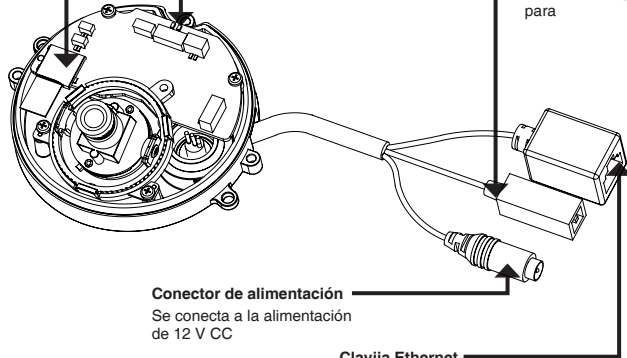

Conector de alimentación
Se conecta a la alimentación de 12 V CC

Clavija Ethernet

Conector RJ-45 para Ethernet que se puede utilizar también para alimentar la cámara usando alimentación a través de Ethernet (PoE)

ESPAÑOL

3. Instalación de la tarjeta SD

Desmonte la cámara

Abra la carcasa de la cámara aflojando los 3 tornillos. Levante el domo separándolo de la base de la cámara.

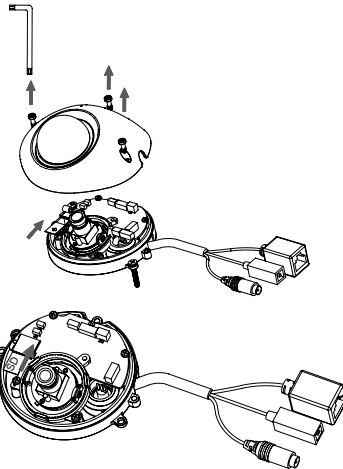

Instale la tarjeta SD

Empuje la tarjeta SD en la cámara, con los contactos dorados orientados hacia la base de la cámara. Para expulsar la tarjeta SD, empuje la tarjeta SD en la ranura.

4. Instalación del hardware

Montaje de la instalación

Consulte el Manual de usuario para obtener instrucciones detalladas relativa a la instalación y montaje de la cámara utilizando un soporte de montaje.



Figura 4.1



Figura 4.2

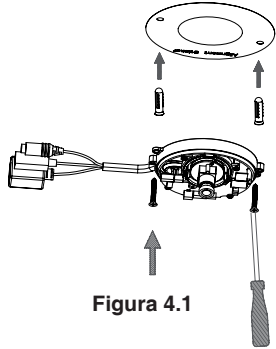

Figura 4.3

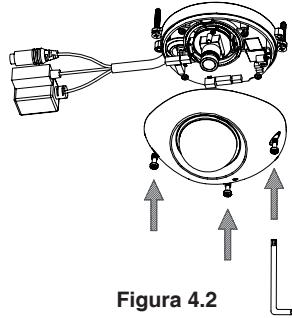

Figura 4.4

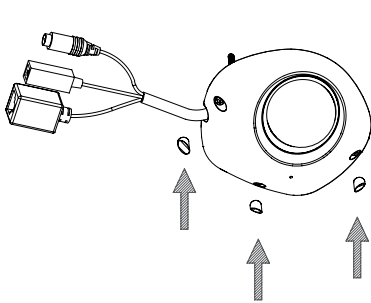

Figura 4.5

Conexión general mediante adaptador de alimentación de 12 V CA

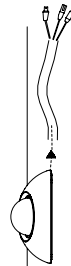
1. Conecte la cámara de red a un terminal mediante un cable Ethernet.
2. Conecte el cable de alimentación suministrado desde la cámara a una toma de alimentación.

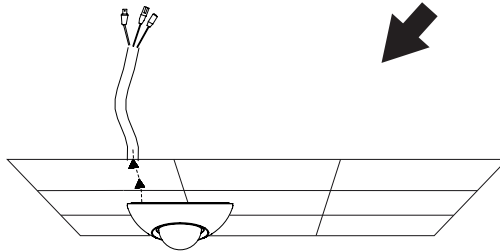
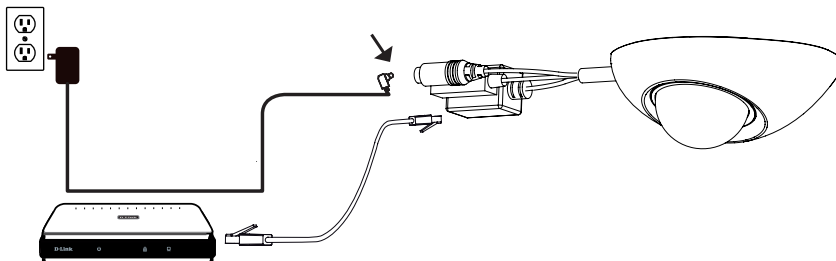

Conexión con un terminal PoE

Si está utilizando un terminal PoE, conecte la cámara IP al terminal mediante un cable Ethernet, el cuál proporcionará transmisión eléctrica y de datos a través de un solo cable.

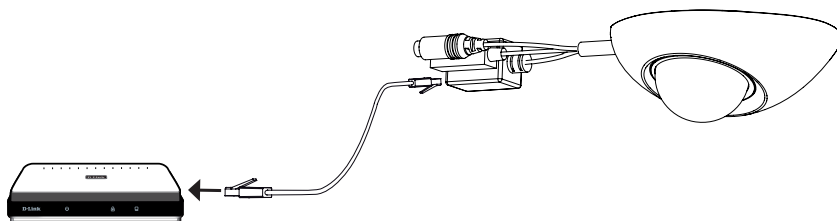

5. Configuración con el asistente

Inserte el CD de la DCS-6210 en la unidad de CD-ROM del ordenador para comenzar la instalación. Si la función de ejecución automática del ordenador está desactivada o si el iniciador de D-Link no se inicia automáticamente, haga clic en **Inicio > Ejecutar**. Escriba **D:\autorun.exe**, donde D: representa la letra de unidad de su unidad de CD-ROM.

Haga clic en **Asistente de configuración** para comenzar la instalación.



Después de hacer clic en el Asistente de configuración, se abrirá la ventana siguiente.

Haga clic en **Siguiente** para continuar.

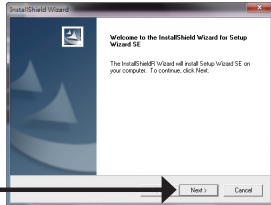

Haga clic en **Sí** para aceptar el acuerdo de licencia.

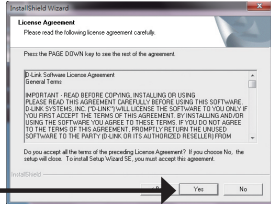

Para iniciar el proceso de instalación, haga clic en **Siguiente**.

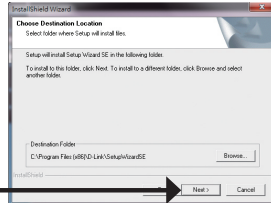

Nota: la instalación puede tardar algunos minutos en finalizar.

Haga clic en **Finalizar** para finalizar la instalación.

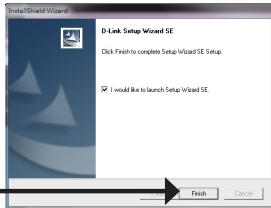

Haga clic en el icono **Asistente de configuración SE D-Link** que se creó en el menú de inicio de Windows.

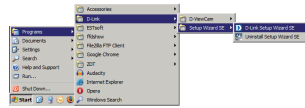

Inicio > D-Link > Asistente de configuración SE

Aparecerá el asistente de configuración y mostrará la dirección MAC y la dirección IP de la cámara. Si tiene un servidor DHCP en la red, se mostrará una dirección IP válida. Si la red no utiliza un servidor DHCP, se mostrará la dirección de IP estática **192.168.0.20** predeterminada de la cámara.

Haga clic en el botón **Asistente** para continuar.



Introduzca el ID de administrador y la contraseña. Al iniciar sesión por primera vez, el ID de administrador predeterminado es **admin**, con la contraseña en blanco.

Haga clic en **Siguiente** para ir a la página siguiente.

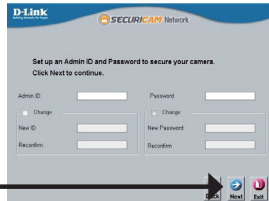

Seleccione DHCP si la cámara obtiene automáticamente una dirección IP al reiniciarse. Seleccione IP estática si la cámara utilizará la misma dirección IP cada vez que se inicia.

Haga clic en **Siguiente** para ir a la página siguiente.



Tómese un tiempo para confirmar la configuración y haga clic en **Reiniciar**.

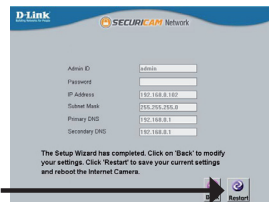

ESPAÑOL

Visualización de la cámara a través del explorador de web

Haga clic en el icono **Asistente de configuración SE D-Link** que se creó en el menú de inicio de Windows.

Inicio > D-Link > Asistente de configuración SE

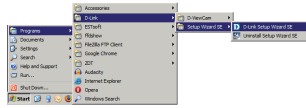

Seleccione la cámara y haga clic en el botón con la etiqueta "**Vínculo**" para acceder a la configuración web.

El asistente de configuración abrirá automáticamente el explorador de web en la dirección IP de la cámara.

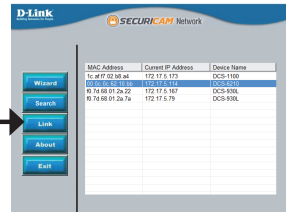

ESPAÑOL

Escriba **admin** como nombre de usuario predeterminado y deje la contraseña en blanco. Haga clic en **Aceptar** para continuar.



Esta sección muestra el vídeo en directo de la cámara. Puede seleccionar el perfil de vídeo y ver o utilizar la cámara. Para obtener información adicional acerca de la configuración de web, consulte el manual de usuario incluido en el CD-ROM o el sitio web de D-Link.

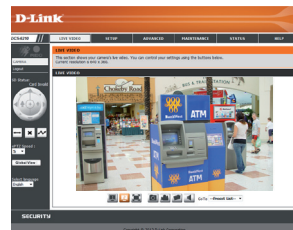

6. Ajuste del ángulo de los 3 ejes de la lente

Ajuste el ángulo de visualización del mecanismo de los 3 ejes

Gire el módulo de la lente a derecha e izquierda hasta que alcance la posición deseada.

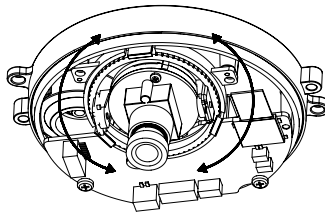

Gire la lente hacia arriba y hacia abajo hasta alcanzar la posición deseada.

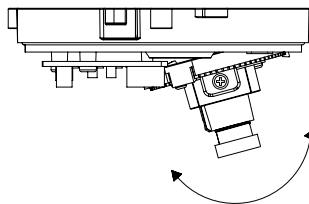

ESPAÑOL

Gire la lente para ajustar la imagen de la cámara IP hasta alcanzar la orientación deseada.

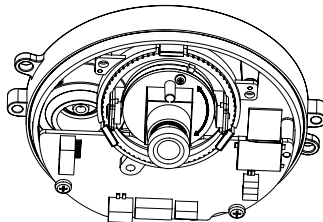

ASISTENCIA TÉCNICA

<http://www.dlink.es>

Asistencia Técnica Telefónica de D-Link: +34 902 30 45 45 0,067 €/min

De Lunes a Viernes de 9:00 a 19:00

NOTES

DCS-6210

In questa guida di installazione sono riportate le istruzioni di base per installare la videocamera DCS-6210 Network Camera in rete. Per ulteriori informazioni sull'utilizzo della videocamera, consultare il manuale utente disponibile sul CD incluso nella confezione o scaricabile dal sito Web di supporto di D-Link.

Procedura di installazione

1. Verificare il contenuto della confezione in base all'elenco seguente.
2. Panoramica hardware
3. Installazione della scheda SD
4. Installazione dell'hardware
5. Procedura guidata di configurazione
6. Regolazione dell'angolo a tre assi dell'obiettivo

1. Contenuto della confezione

- DCS-6210 Network camera
- Manuale e software su CD-ROM
- Guida di installazione rapida
- Alimentatore
- Cavo Ethernet CAT-5
- Cacciavite e viti per l'installazione
- Adesivo per l'allineamento
- Gommini

Se uno o più degli articoli sopra elencati risultano mancanti, rivolgersi al rivenditore.

Nota relativa alla sicurezza:

Per evitare di invalidare la garanzia, l'installazione e le riparazioni devono essere effettuate da tecnici qualificati in conformità alle normative locali.

2. Panoramica hardware

Slot per schede SD/SDHC

Slot per schede SD/SDHC locali utilizzate per archiviare le immagini e i video registrati

LED

Indicatore di alimentazione e di rete

Reset

Tenere premuto questo pulsante per 10 secondi per resettare la videocamera

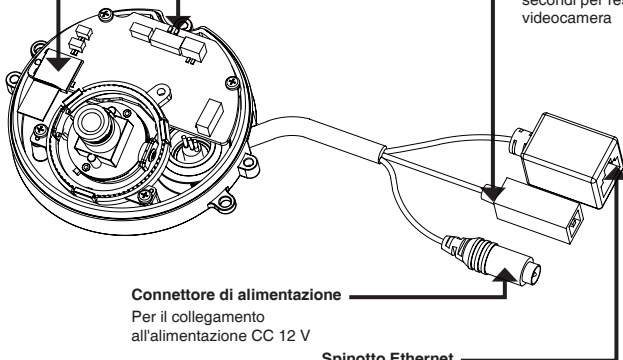

Connettore di alimentazione

Per il collegamento all'alimentazione CC 12 V

Spinotto Ethernet

Connettore RJ-45 per Ethernet che può essere utilizzato anche per alimentare la videocamera quando si utilizza PoE (Power over Ethernet)

3. Installazione della scheda SD

ITALIANO

Disassemblare la videocamera

Allentare le tre viti per aprire l'involucro protettivo della videocamera. Staccare la cupola dalla base della videocamera.

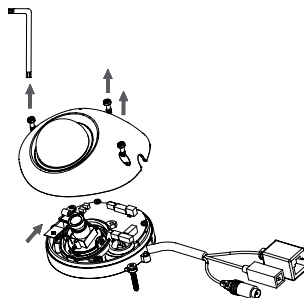

Installare la scheda SD

Inserire la scheda SD nella videocamera con i contatti dorati rivolti verso la base della videocamera. Per espellere la scheda, spingerla nell'alloggiamento.

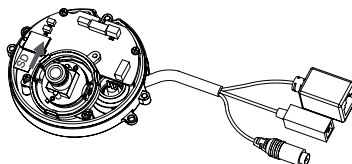

4. Istruzioni per il montaggio standard

Installazione della staffa di montaggio

Per istruzioni dettagliate sull'installazione e il montaggio della videocamera con una staffa di montaggio, consultare il Manuale utente.

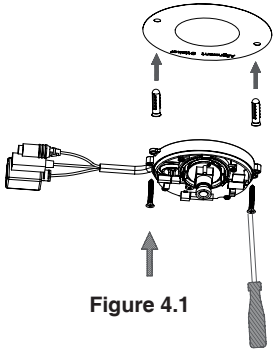

Figure 4.1

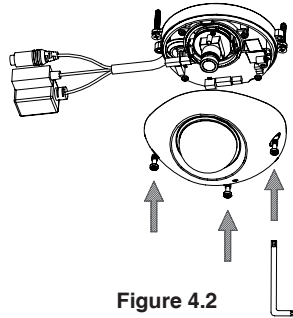

Figure 4.2

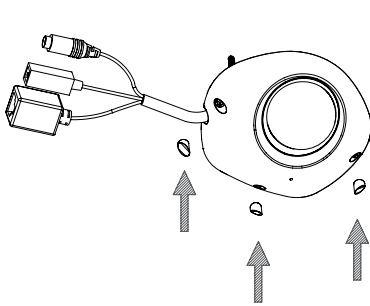

Figure 4.3

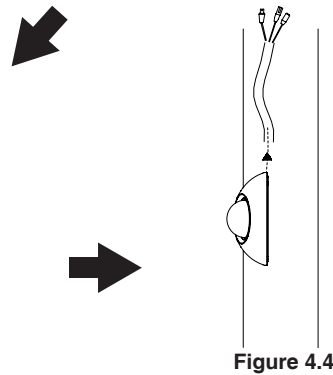

Figure 4.4

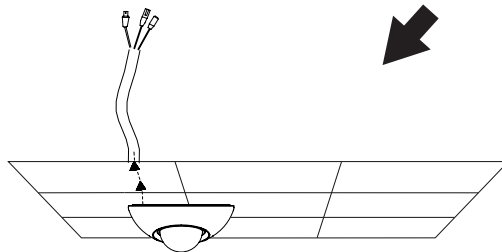
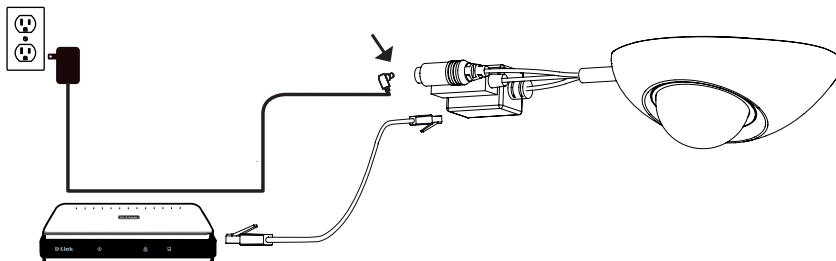

Figure 4.5

Collegamento generico con adattatore di alimentazione CC 12 V

1. Collegare la videocamera di rete a un hub tramite un cavo Ethernet.
2. Collegare un'estremità del cavo di alimentazione fornito alla telecamera e l'altra estremità a una presa elettrica.



Collegamento con hub PoE

Se si utilizza un hub PoE, collegare la videocamera IP all'hub tramite un cavo Ethernet, che verrà utilizzato sia per l'alimentazione che per la trasmissione dei dati.

ITALIANO

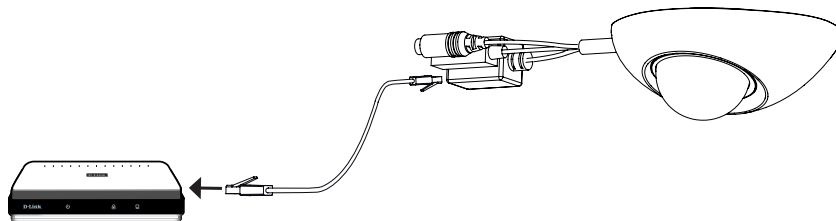

5. Procedura guidata di configurazione

Inserire il CD di DCS-6210 nell'unità CD-ROM del computer per avviare l'installazione. Se la funzione di esecuzione automatica è disabilitata nel computer in uso o se l'utilità di avvio di D-Link non viene avviata automaticamente, fare clic su **Start > Run** (Start > Esegui). Digitare **D:\autorun.exe**, dove D: rappresenta la lettera dell'unità CD-ROM.

Fare clic su **Setup Wizard** (Installazione guidata) per avviare l'installazione.



Dopo aver fatto clic sul comando dell'installazione guidata, verrà aperta la seguente finestra.

Fare clic su **Next** (Avanti) per continuare.

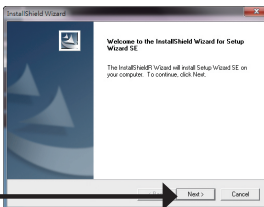

Fare clic su **Yes** (Sì) per accettare il contratto di Licenza.

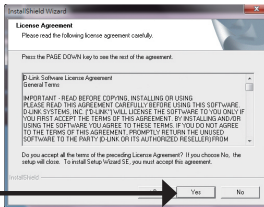

Per avviare il processo di installazione, fare clic su **Next** (Avanti).

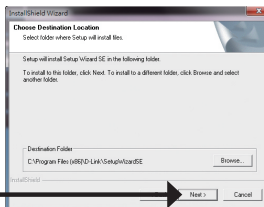

Nota: il completamento dell'installazione può richiedere alcuni minuti.

Fare clic su **Finish** (Fine) per completare l'installazione.

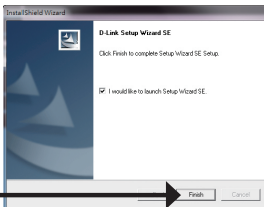

Fare clic sull'icona **D-Link Setup Wizard SE** creata nel menu di Start di Windows.

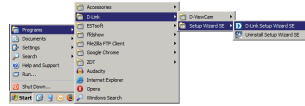

Start > D-Link > Setup Wizard SE

Nella pagina dell'installazione guidata verranno visualizzati l'indirizzo MAC e l'indirizzo IP della telecamera. Se la rete dispone di un server DHCP, viene visualizzato un indirizzo IP valido. Se la rete non dispone di un server DHCP, verrà visualizzato l'indirizzo IP statico predefinito della telecamera di rete, ovvero **192.168.0.20**.

Fare clic su **Wizard** (Installazione guidata) per continuare.



Inserire l'ID dell'amministratore e la password. Quando si effettua l'accesso per la prima volta, l'ID predefinito dell'amministratore è **admin**, mentre la password viene lasciata vuota.

Fare clic su **Next** (Avanti) per passare alla pagina successiva.

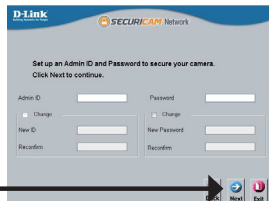

Selezionare l'opzione DHCP se la telecamera in uso ottiene automaticamente un indirizzo IP all'avvio. Selezionare l'opzione Static IP (IP statico) se la telecamera utilizzerà lo stesso indirizzo IP ogni volta che viene avviato.

Fare clic su **Next** (Avanti) per passare alla pagina successiva.



Verificare le impostazioni, quindi fare clic su **Restart** (Riavvia).

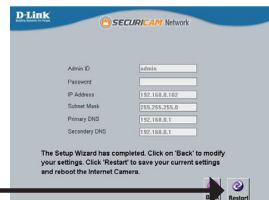

Visualizzazione della telecamera tramite il browser Web

Fare clic sull'icona **D-Link Setup Wizard SE** creata nel menu di Start di Windows.

Start > D-Link > Setup Wizard SE

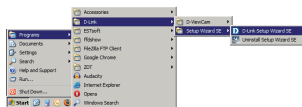

Selezionare la telecamera e fare clic sul pulsante "**Link**" (Collegamento) per accedere alla configurazione Web.

La procedura guidata di configurazione apre automaticamente il browser Web all'indirizzo IP della telecamera.



Immettere **admin** come nome utente predefinito e lasciare il campo password vuoto. Fare clic su **OK** per continuare.

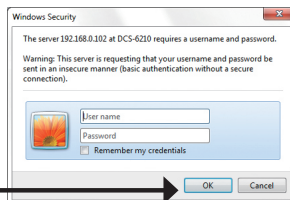

Questa sezione descrive il video in diretta della telecamera. È possibile selezionare il profilo video desiderato e visualizzare le immagini o mettere in funzione la telecamera. Per ulteriori informazioni sulla configurazione Web, fare riferimento al manuale utente incluso sul CD-ROM o scaricabile dal sito Web di D-Link.



6. Regolazione dell'angolo a tre assi dell'obiettivo

Regolare l'angolo di visualizzazione agendo sui meccanismi dei tre assi

Ruotare verso sinistra e verso destra il modulo dell'obiettivo fino a raggiungere la posizione desiderata.

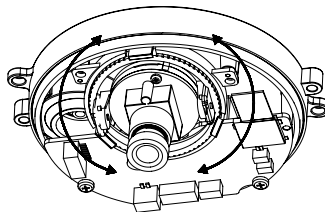

Ruotare verso l'alto e verso il basso l'obiettivo fino a raggiungere la posizione desiderata.

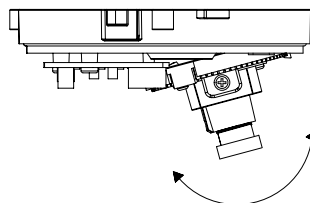

Ruotare l'obiettivo per regolare l'immagine acquisita dalla videocamera IP fino a ottenere l'orientamento desiderato.

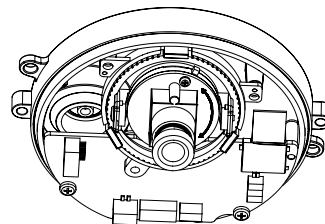

ITALIANO

SUPPORTO TECNICO

<http://www.dlink.it/support>

Supporto Tecnico dal lunedì al venerdì dalle ore 9.00 alle ore 19.00 con orario continuato

Telefono: 02 87366396

NOTES

D-Link®



Ver. 1.00(EU)
2012/09/18
RMN0100930