

# Installation and Quick Start

## In-Line Current Meter

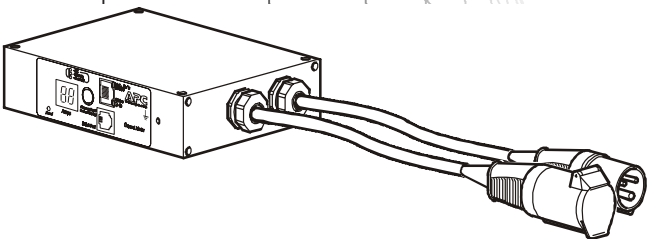



---

This manual is available in English on the enclosed CD.

Dieses Handbuch ist in Deutsch auf der beiliegenden CD-ROM verfügbar.

Este manual está disponible en español en el CD-ROM adjunto.

Ce manuel est disponible en français sur le CD-ROM ci-inclus.

Questo manuale è disponibile in italiano nel CD-ROM allegato.

Instrukcja Obsługi w języku polskim jest dostępna na CD.

Данное руководство на русском языке имеется на прилагаемом компакт-диске.

Bu kullanım kilavuzunun Türkçe'sä, äläxäkte gönderälen CD äçeräsände mevcuttur.

Este manual está disponível em português no CD fornecido.

# Contents

---

<b>Preliminary Information</b>	<b>1</b>
Features	1
Digital display	1
Receiving inspection	1
Please recycle	1
<b>Install the In-Line Current Meter</b>	<b>2</b>
Mounting options	2
Roof	2
Vertical mounting rail	3
<b>Digital Display Operation</b>	<b>4</b>
<b>Quick Configuration</b>	<b>5</b>
Overview	5
TCP/IP configuration methods	5
APC Device IP Configuration Wizard	5
BOOTP & DHCP configuration	6
Local access to the control console	8
Remote access to the control console	9
Control console	10
<b>Access a Configured In-Line Current Meter</b>	<b>11</b>
Overview	11
Web interface	11
Telnet and SSH	12
Simple Network Management Protocol (SNMP)	12
FTP and SCP	13
Managing the security of your system	13
<b>Recover From a Lost Password</b>	<b>14</b>
<b>Update Firmware</b>	<b>15</b>
<b>Two-Year Factory Warranty</b>	<b>16</b>
Terms of warranty	16
Non-transferable warranty	16
Exclusions	16
Warranty claims	17
<b>Life-Support Policy</b>	<b>18</b>
General policy	18
Examples of life-support devices	18



# Preliminary Information

## Features

This booklet provides information on installing and operating the In-Line Current Meter. Each Current Meter has a sensor that measures the current being used by the attached device and can be monitored through the Web, Telnet, SSH, SNMP, or InfraStruXure<sup>®</sup> Manager and Central interfaces.

## Digital display

A digital display shows aggregate current being used per phase by the device attached to the Current Meter. An alarm occurs if the aggregate current is above the high threshold value or below the low threshold value that you configure.

## Receiving inspection

Inspect the package and contents for shipping damage, and make sure that all parts were sent. Report any damage immediately to the shipping agent, and report missing contents, damage, or other problems immediately to APC or your APC reseller.

## Please recycle



The shipping materials are recyclable. Please save them for later use, or dispose of them appropriately.

# Install the In-Line Current Meter

## Mounting options

Install the Current Meter in one of the two following ways using the mounting brackets (provided): on the roof of the enclosure or on the inside of the enclosure mounted on the vertical mounting rails.

### Roof

1. Attach the two mounting brackets to the Current Meter with the screws (provided).



**Caution:** Use only the supplied screws.

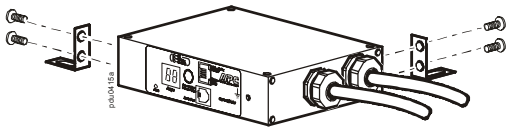

2. Attach the cage nuts (provided with your enclosure) to the inside of the roof.
3. Secure the mounting brackets attached to the Current Meter to the cage nuts installed in the roof.

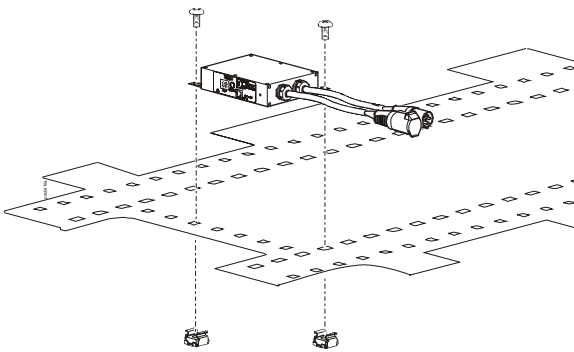

**Note:** You can mount multiple Current Meters on top of each other using additional mounting brackets (provided).

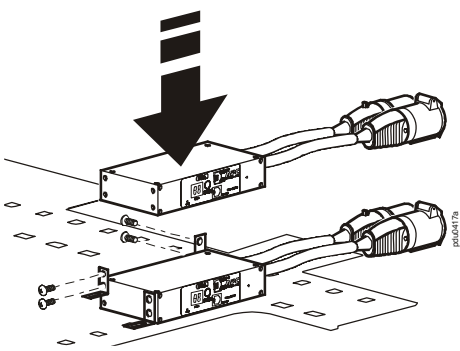

## Vertical mounting rail

1. Attach the two mounting brackets to the back of the Current Meter with the screws (provided).

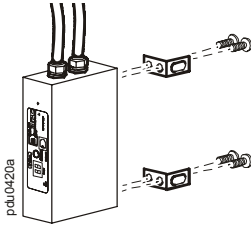

2. Install the cage nuts (provided with your enclosure) into the vertical mounting rail.
3. Route the power cords to the top of the enclosure and through the roof.
4. Attach the brackets to the mounting rail with the screws (provided with your enclosure).

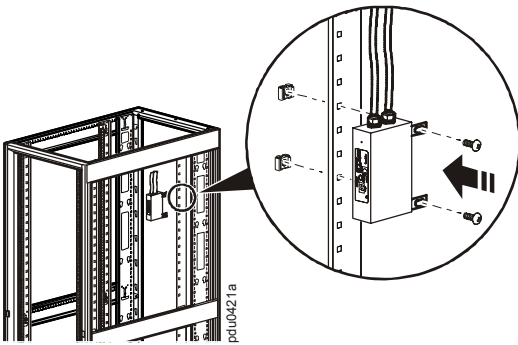

# Digital Display Operation

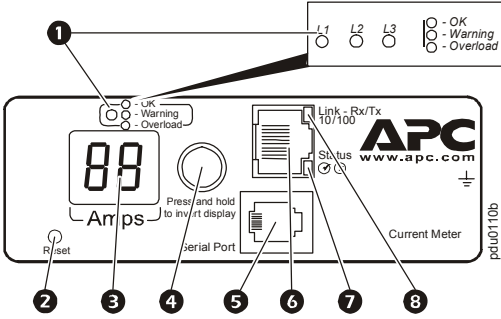

1	Phase indicator LED: Indicates normal (green), warning (yellow), or alarm (red) condition.
2	Reset button: Resets the Current Meter without affecting the attached devices.
3	<p>Display of the current used by the Current Meter and attached devices:</p> <ul style="list-style-type: none"> <li>Shows the current being used per phase by the device attached to the Current Meter.</li> <li>Cycles through in 3-second intervals, and goes through all 3 readings (3 phases).</li> </ul>
4	<p>Control button:</p> <ul style="list-style-type: none"> <li>Press to change the reading of the current displayed on the digital display.</li> <li>Press and hold for five seconds to view the IP address of the Current Meter.</li> <li>Hold for an additional five seconds to change the orientation.</li> </ul>
5	Serial port: Access internal menus by connecting this port (RJ-11 modular port) to a serial port on your computer, using the supplied serial cable (APC part number 940-0144A).
6	Ethernet port: Connects the Current Meter to your network, using a CAT-5 network cable.
7	<p>Status LED: Indicates the status of the Ethernet LAN connection and the state of the Current Meter.</p> <ul style="list-style-type: none"> <li><b>Off</b>—The Current Meter has no power.</li> <li><b>Solid green</b>—The Current Meter has valid TCP/IP settings.</li> <li><b>Flashing green</b>—The Current Meter does not have valid TCP/IP settings.</li> <li><b>Solid orange</b>—A hardware failure has been detected in the Current Meter. Contact Customer Support at a phone number on the back cover of this manual.</li> <li><b>Flashing orange</b>—The Current Meter is making BOOTP requests.</li> </ul>
8	Link LED: Indicates whether there is activity on the network.



# Quick Configuration



**Caution:** Disregard the procedures in this section if you have APC InfraStruXure Manager or Central as part of your system. See the documentation of your InfraStruXure device for more information.

## Overview

You must configure the following TCP/IP settings before the Current Meter can operate on a network:

- IP address of the Current Meter
- Subnet mask
- Default gateway



**Note:** If a default gateway is unavailable, use the IP address of a computer that is located on the same subnet as the Current Meter and that is usually running. The Current Meter uses the default gateway to test the network when traffic is very light.



**Caution:** Do not use the loopback address (127.0.0.1) as the default gateway address. It disables the Current Meters network connection and requires you to reset TCP/IP settings to their defaults using a local serial login.



See “Watchdog Features” in the “Introduction” of the *User’s Guide* for more information about the watchdog role of the default gateway.

## TCP/IP configuration methods

Use one of the following methods to define the TCP/IP settings:

- APC Device IP Configuration Wizard (See “APC Device IP Configuration Wizard” on this page)
- BOOTP or DHCP server (See “BOOTP & DHCP configuration” on page 6.)
- Local computer (See “Local access to the control console” on page 8.)
- Networked computer (See “Remote access to the control console” on page 9.)

## APC Device IP Configuration Wizard

You can use the APC Device IP Configuration Wizard at a computer running Microsoft® Windows® 2000, Windows Server 2003, or Windows XP to configure the basic TCP/IP settings of a Current Meter.



**Note:** Most software firewalls must be temporarily disabled for the Wizard to discover unconfigured Current Meters

1. Insert the APC Metered Rack Power Distribution Unit *Utility CD* into a computer on your network.
2. If autorun is enabled, the user interface of the CD starts when you insert the CD. Otherwise, open the file **contents.htm** on the CD.
3. Click **Device IP Configuration Wizard** and follow the instructions.



**Note:** If you leave the **Start a Web browser when finished** option enabled, you can use **apc** for both the user name and password to access the Current Meter through your browser.

## BOOTP & DHCP configuration

At the Web interface, select the **Administration** tab, **Network** from the top menu bar, then **TCP/IP** from the left navigation menu to identify how TCP/IP settings will be defined. The default TCP/IP configuration setting, **BOOTP & DHCP**, assumes that a properly configured BOOTP or DHCP server is available to provide TCP/IP settings to the Current Meter. The Current Meter first attempts to discover a properly configured BOOTP server, and then a DHCP server. It repeats this pattern until it discovers a BOOTP or DHCP server.

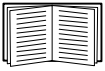

If neither of these servers are available, see “APC Device IP Configuration Wizard” on page 5, “Local access to the control console” on page 8, or “Remote access to the control console” on page 9 to configure the needed TCP/IP settings.

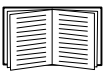

A user configuration (.ini) file can function as a BOOTP or DHCP boot file. For more information, see the TCP/IP configuration section of the Metered Rack Power Distribution *User’s Guide*, available on the enclosed *Utility CD*, or on the APC Web site, **www.apc.com**.

**BOOTP.** You can use an RFC951-compliant BOOTP server to configure the TCP/IP settings for the Current Meter. If the BOOTP server is properly configured, the Current Meter’s default setting (**DHCP & BOOTP**) for **TCP/IP** configuration causes it to discover the BOOTP server.

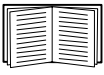

If a BOOTP server is unavailable, see “APC Device IP Configuration Wizard” on page 5, “Local access to the control console” on page 8, or “Remote access to the control console” on page 9 to configure TCP/IP settings.

1. Enter the Current Meters MAC and IP addresses, the subnet mask and default gateway settings, and an optional bootup file name in the BOOTPTAB file of the BOOTP server.

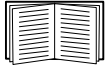

For the MAC address, look on the bottom of the Current Meter or on the Quality Assurance slip included in the package.

2. When the Current Meter reboots, the BOOTP server provides it with the TCP/IP settings.
  - If you specified a bootup file name, the Current Meter attempts to transfer that file from the BOOTP server using TFTP or FTP. The Current Meter assumes all settings specified in the bootup file.
  - If you did not specify a bootup file name, the Current Meter can be configured remotely by using Telnet or by using the Web interface: **user name** and **password** are both **apc**, by default.

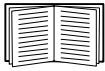

To create a bootup file, see your BOOTP server documentation.

**DHCP.** You can use a RFC2131/RFC2132-compliant DHCP server to configure the TCP/IP settings for the Current Meter.

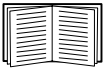

This section summarizes the Current Meters communication with a DHCP server. For more detail about how a DHCP server is used to configure the network settings for the Current Meter, see “DHCP Configuration Settings” in the *User’s Guide*.

1. The Current Meter sends a DHCP request that uses the following to identify itself:
  - Vendor Class Identifier (APC by default).
  - Client Identifier (by default, the Current Meters MAC address).
  - User Class Identifier (by default, the identification of the Current Meter’s application firmware).
2. A properly configured DHCP server responds with a DHCP offer that includes all of the settings that the Current Meter needs for network communication. The DHCP offer

also includes the **Vendor Specific Information** option (DHCP option 43). By default, the Current Meter ignores DHCP offers that do not encapsulate the APC cookie in the **Vendor Specific Information** option using the following hexadecimal format:

Option 43 = 01 04 31 41 50 43

where

- The first byte (01) is the code.
- The second byte (04) is the length.
- The remaining bytes (31 41 50 43) are the APC cookie.



See your DHCP server documentation to add code to the Vendor Specific Information option.



You can use a local computer to disable the APC cookie requirement. To use a local computer, see “Local access to the control console” on this page. To change the control consoles **DHCP Cookie Is** setting, an **Advanced** option in the **TCP/IP** menu, use Telnet or another remote accessing method. To access the control console, see “Remote access to the control console” on page 9.

## Local access to the control console

You can use a local computer to connect to the Current Meter to access the control console.

1. Select a serial port at the local computer, and disable any service which uses that port.
2. Use the serial cable (APC part number 940-0144A) to connect the selected port to the serial port on the front panel of the Current Meter.
3. Run a terminal program (such as HyperTerminal<sup>®</sup>) and configure the selected port for 9600 bps, 8 data bits, no parity, 1 stop bit, and no flow control. Save the changes.
4. Press ENTER to display the **User Name** prompt.
5. Use **apc** for the user name and password.
6. See “Control console” on page 10 to finish the configuration.

## Remote access to the control console

From any computer on the same subnet as the Current Meter, you can use ARP and Ping to assign an IP address to the Current Meter, and then use Telnet to access that Current Meter's control console and configure the needed TCP/IP settings.



**Note:** After the Current Meter has its IP address configured, you can use Telnet, without first using ARP and Ping, to access that Current Meter.

1. Use ARP to define an IP address for the Current Meter, and use the Current Meters MAC address in the ARP command. For example, to define an IP address of 156.205.14.141 for the Current Meter that has a MAC address of 00 c0 b7 63 9f 67, use one of the following commands:

–Windows command format:

```
arp -s 156.205.14.141 00-c0-b7-63-9f-67
```

–LINUX command format:

```
arp -s 156.205.14.141 00:c0:b7:63:9f:67
```



**Note:** The MAC address is on the bottom of the Current Meter and on the Quality Assurance slip included in the package.

2. Use Ping with a size of 113 bytes to assign the IP address defined by the ARP command. For example:

–Windows command format:

```
ping 156.205.14.141 -l 113
```

–LINUX command format:

```
ping 156.205.14.141 -s 113
```

3. Use Telnet to access the Current Meter at its newly assigned IP address. For example:

```
telnet 156.205.14.141
```

4. Use **apc** for both **user name** and **password**.
5. See “Control console” on page 10 to finish the configuration.

## Control console

After you log on at the control console, as described in “Local access to the control console” on page 8 or “Remote access to the control console” on page 9:

1. Choose **Network** from the **Control Console** menu.
2. Choose **TCP/IP** from the **Network** menu.
3. If you are not using a BOOTP or DHCP server to configure the TCP/IP settings, select the **Boot Mode** menu. Select **Manual boot mode**, and then press ESC to return to the **TCP/IP** menu. Set the **System IP**, **Subnet Mask**, and **Default Gateway** address values. (Changes will take effect when you log off.)
4. Press CTRL+C to exit to the **Control Console** menu.
5. Log off (option 4 in the **Control Console** menu).



**Note:** If you disconnected a cable during the procedure described in “Local access to the control console” on page 8, reconnect that cable and restart the associated service.

# Access a Configured In-Line Current Meter

## Overview

After the Current Meter is running on your network, you can use the interfaces summarized here to access the unit.

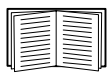

For more information on the interfaces, see the *User's Guide*.

## Web interface

Use Microsoft Internet Explorer (IE) 5.5 or higher (on Windows operating systems only), Firefox, version 1.x, by Mozilla Corporation (on all operating systems), or Netscape® 7.x or higher (on all operating systems) to access the Current Meter through its Web interface. Other commonly available browsers also may work but have not been fully tested by APC.

To use the Web browser to configure Current Meter options or to view the event log, you can use either of the following:

- The HTTP protocol (enabled by default), which provides authentication by user name and password but no encryption.
- The more secure HTTPS protocol, which provides extra security through Secure Socket Layer (SSL) and encrypts user names, passwords, and data being transmitted. It also provides authentication of Current Meters by means of digital certificates.

To access the Web interface and configure the security of your device on the network:

1. Address the Current Meter by its IP address or DNS name (if configured).
2. Enter the user name and password (by default, **apc** and **apc** for an Administrator).
3. Select and configure the type of security you want.

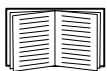

See the *Security Handbook: Network-Enabled Devices*, available on the APC Metered Rack Power Distribution Unit *Utility CD* or from the APC Web site, **www.apc.com**, for more information on selecting and configuring network security.

## Telnet and SSH

You can access the control console through Telnet or Secure SHell (SSH), depending on which is enabled. (On the **Administration** tab, select **Network** on the top menu bar and select **access** under the **Console** heading on the left navigation menu to enable these access methods.) By default, Telnet is enabled. Enabling SSH automatically disables Telnet.

**Telnet for basic access.** Telnet provides the basic security of authentication by user name and password, but not the high-security benefits of encryption. To use Telnet to access the control console of the Current Meter from any computer:

1. At a command prompt, use the following command line, and press ENTER:

```
telnet address
```

As *address*, use the Current Meters IP address (or DNS name if configured).

2. Enter the user name and password (by default, **apc** and **apc** for an Administrator, or **device** and **apc** for a Device Manager).

**SSH for high-security access.** If you use the high security of SSL for the Web interface, use Secure SHell (SSH) for access to the control console. SSH encrypts user names, passwords, and transmitted data.

The interface, user accounts, and user access rights are the same whether you access the control console through SSH or Telnet, but to use SSH, you must first configure SSH and have an SSH client program installed on your computer.



See the *User's Guide* for more information on configuring and using SSH.

## Simple Network Management Protocol (SNMP)

**SNMPv1 only.** After you add the APC PowerNet<sup>®</sup> MIB to a standard SNMP MIB browser, you can use that browser to access the Current Meter. All user names, passwords, and community names for SNMP are transferred over the network as plain text. The default read community name is **public**; the default read/write community name is **private**.

**SNMPv3 only.** For SNMP GETs, SETs, and trap receivers, SNMPv3 uses a system of user profiles to identify users. An SNMPv3 user must have a user profile assigned in the MIB software program to perform GETs and SETs, browse the MIB, and receive traps. The default settings are **no authentication** and **no privacy**.





**Note:** To use SNMPv3, you must have a MIB program that supports SNMPv3.

The Current Meter supports only MD5 authentication and DES encryption.

**SNMPv1 and SNMPv3.** To use InfraStruXure Central or Manager to manage the Current Meter on the public network of an InfraStruXure system, you must have SNMPv1 enabled in the unit interface. Read access allows InfraStruXure devices to receive traps from the Current Meter. Write access is required while you set the InfraStruXure device as a trap receiver.

To enable or disable SNMP access, you must be an Administrator. Select the **Administrator** tab, select the **Network** menu on the top menu bar, and use the **access** option under **SNMPv1** or **SNMPv3** on the left navigation menu.

## FTP and SCP

You can use FTP (enabled by default) or Secure CoPy (SCP) to transfer downloaded firmware to the Current Meter, or to access a copy of the Current Meters event or data logs. SCP provides the higher security of encrypted data transmission and is enabled automatically when you enable SSH.

To use InfraStruXure Manager or Central to manage a Current Meter, you must have **FTP Server** enabled in the Current Meter interface.

To enable or disable **FTP Server** access, you must be an Administrator. Select the **Administration** tab, select the **Network** menu on the top menu bar, and use the **FTP Server** option on the left navigation menu.

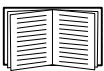

In the *Metered Rack Power Distribution User's Guide*, see the following sections:

- To transfer firmware, see “File Transfers.”
- To retrieve a copy of the event or data log, see “How to use FTP or SCP to retrieve log files.”

## Managing the security of your system



For detailed information on enhancing the security of your system after installation and initial configuration, see the *Security Handbook*, available on the APC Metered Rack Power Distribution Unit *Utility* CD and on the APC Web site, [www.apc.com](http://www.apc.com).

# Recover From a Lost Password

You can use a local computer (a computer that connects to the Current Meter through the serial port) to access the control console.

1. Select a serial port at the local computer, and disable any service that uses that port.
2. Connect the provided serial cable (APC part number 940-0144A) to the selected port on the computer and to the configuration port at the Current Meter.
3. Run a terminal program (such as HyperTerminal) and configure the selected port as follows: 9600 bps, 8 data bits, no parity, 1 stop bit, and no flow control.
4. Press ENTER, repeatedly if necessary, to display the **User Name** prompt. If you are unable to display the **User Name** prompt, verify the following:
  - The serial port is not in use by another application.
  - The terminal settings are correct as specified in step 3.
  - The correct cable is being used as specified in step 2.
5. Press the **Reset** button. The Status LED will flash alternately orange and green. Press the **Reset** button a second time immediately while the LED is flashing to reset the user name and password to their defaults temporarily.
6. Press ENTER as many times as necessary to redisplay the **User Name** prompt, then use the default, **apc**, for the user name and password. (If you take longer than 30 seconds to log on after the **User Name** prompt is redisplayed, you must repeat step 5 and log on again.)
7. From the **Control Console** menu, select **System**, then **User Manager**.
8. Select **Administrator**, and change the **User Name** and **Password** settings, both of which are now defined as **apc**.
9. Press CTRL+C, log off, reconnect any serial cable you disconnected, and restart any service you disabled.

# Update Firmware

To obtain firmware for your Current Meter, download the latest firmware revision from [www.apc.com/tools/download](http://www.apc.com/tools/download) on the APC Web site.



For a complete description on how to transfer a downloaded firmware upgrade to your Current Meter, see “File Transfers” in the Metered Rack Power Distribution *User’s Guide* on the provided APC Metered Rack Power Distribution Unit *Utility CD* and also available from the APC Web site [www.apc.com](http://www.apc.com).



**Caution:** Do not interrupt the transfer. The Current Meter will reboot when the transfer is complete.



**Note:** Upgrading the firmware will not interfere with the operation of the outlets.

# Two-Year Factory Warranty

This warranty applies only to the products you purchase for your use in accordance with this manual.

## Terms of warranty

APC warrants its products to be free from defects in materials and workmanship for a period of two years from the date of purchase. APC will repair or replace defective products covered by this warranty. This warranty does not apply to equipment that has been damaged by accident, negligence or misapplication or has been altered or modified in any way. Repair or replacement of a defective product or part thereof does not extend the original warranty period. Any parts furnished under this warranty may be new or factory-remanufactured.

## Non-transferable warranty

This warranty extends only to the original purchaser who must have properly registered the product. The product may be registered at the APC Web site, [www.apc.com](http://www.apc.com).

## Exclusions

APC shall not be liable under the warranty if its testing and examination disclose that the alleged defect in the product does not exist or was caused by end user's or any third person's misuse, negligence, improper installation or testing. Further, APC shall not be liable under the warranty for unauthorized attempts to repair or modify wrong or inadequate electrical voltage or connection, inappropriate on-site operation conditions, corrosive atmosphere, repair, installation, exposure to the elements, Acts of God, fire, theft, or installation contrary to APC recommendations or specifications or in any event if the APC serial number has been altered, defaced, or removed, or any other cause beyond the range of the intended use.

**THERE ARE NO WARRANTIES, EXPRESS OR IMPLIED, BY OPERATION OF LAW OR OTHERWISE, OF PRODUCTS SOLD, SERVICED OR FURNISHED UNDER THIS AGREEMENT OR IN CONNECTION HERewith. APC DISCLAIMS ALL IMPLIED WARRANTIES OF MERCHANTABILITY, SATISFACTION AND FITNESS FOR A PARTICULAR PURPOSE. APC EXPRESS WARRANTIES WILL NOT BE ENLARGED, DIMINISHED, OR AFFECTED BY AND NO OBLIGATION OR LIABILITY WILL ARISE OUT OF, APC RENDERING OF TECHNICAL OR OTHER ADVICE OR SERVICE IN CONNECTION WITH THE PRODUCTS. THE FOREGOING WARRANTIES AND REMEDIES ARE EXCLUSIVE AND IN LIEU OF ALL**

**OTHER WARRANTIES AND REMEDIES. THE WARRANTIES SET FORTH ABOVE CONSTITUTE APC'S SOLE LIABILITY AND PURCHASER'S EXCLUSIVE REMEDY FOR ANY BREACH OF SUCH WARRANTIES. APC WARRANTIES EXTEND ONLY TO PURCHASER AND ARE NOT EXTENDED TO ANY THIRD PARTIES.**

**IN NO EVENT SHALL APC, ITS OFFICERS, DIRECTORS, AFFILIATES OR EMPLOYEES BE LIABLE FOR ANY FORM OF INDIRECT, SPECIAL, CONSEQUENTIAL OR PUNITIVE DAMAGES, ARISING OUT OF THE USE, SERVICE OR INSTALLATION, OF THE PRODUCTS, WHETHER SUCH DAMAGES ARISE IN CONTRACT OR TORT, IRRESPECTIVE OF FAULT, NEGLIGENCE OR STRICT LIABILITY OR WHETHER APC HAS BEEN ADVISED IN ADVANCE OF THE POSSIBILITY OF SUCH DAMAGES. SPECIFICALLY, APC IS NOT LIABLE FOR ANY COSTS, SUCH AS LOST PROFITS OR REVENUE, LOSS OF EQUIPMENT, LOSS OF USE OF EQUIPMENT, LOSS OF SOFTWARE, LOSS OF DATA, COSTS OF SUBSTITUENTS, CLAIMS BY THIRD PARTIES, OR OTHERWISE.**

**NO SALESMAN, EMPLOYEE OR AGENT OF APC IS AUTHORIZED TO ADD TO OR VARY THE TERMS OF THIS WARRANTY. WARRANTY TERMS MAY BE MODIFIED, IF AT ALL, ONLY IN WRITING SIGNED BY AN APC OFFICER AND LEGAL DEPARTMENT.**

### **Warranty claims**

Customers with warranty claims issues may access the APC customer support network through the Support page of the APC Web site, [www.apc.com/support](http://www.apc.com/support). Select your country from the country selection pull-down menu at the top of the Web page. Select the Support tab to obtain contact information for customer support in your region.

# Life-Support Policy

## General policy

American Power Conversion (APC) does not recommend the use of any of its products in the following situations:

- In life-support applications where failure or malfunction of the APC product can be reasonably expected to cause failure of the life-support device or to affect significantly its safety or effectiveness.
- In direct patient care.

APC will not knowingly sell its products for use in such applications unless it receives in writing assurances satisfactory to APC that (a) the risks of injury or damage have been minimized, (b) the customer assumes all such risks, and (c) the liability of APC is adequately protected under the circumstances.

## Examples of life-support devices

The term *life-support device* includes but is not limited to neonatal oxygen analyzers, nerve stimulators (whether used for anesthesia, pain relief, or other purposes), autotransfusion devices, blood pumps, defibrillators, arrhythmia detectors and alarms, pacemakers, hemodialysis systems, peritoneal dialysis systems, neonatal ventilator incubators, ventilators (for adults and infants), anesthesia ventilators, infusion pumps, and any other devices designated as “critical” by the U.S. FDA.

Hospital-grade wiring devices and leakage current protection may be ordered as options on many APC UPS systems. APC does not claim that units with these modifications are certified or listed as hospital-grade by APC or any other organization. Therefore these units do not meet the requirements for use in direct patient care.



# APC Worldwide Customer Support

Customer support for this or any other APC product is available at no charge in any of the following ways:

- Visit the APC Web site to access documents in the APC Knowledge Base and to submit customer support requests.
  - **www.apc.com** (Corporate Headquarters)  
Connect to localized APC Web sites for specific countries, each of which provides customer support information.
  - **www.apc.com/support/**  
Global support searching APC Knowledge Base and using e-support.
- Contact an APC Customer Support center by telephone or e-mail.
  - Regional centers

Direct InfraStruXure (1)(877)537-0607  
Customer Support Line (toll free)

APC headquarters U.S., (1)(800)800-4272  
Canada (toll free)

Latin America (1)(401)789-5735  
(USA)

Europe, Middle East, (353)(91)702000  
Africa (Ireland)

Western Europe (inc. +800 0272 0272  
Scandinavia)

Japan (0) 3 6402-2001

Australia, New Zealand, (61) (2) 9955 9366  
South Pacific area (Australia)

- Local, country-specific centers: go to **www.apc.com/support/contact** for contact information.

Contact the APC representative or other distributor from whom you purchased your APC product for information on how to obtain local customer support.

Entire contents copyright 2007 American Power Conversion Corporation. All rights reserved. Reproduction in whole or in part without permission is prohibited. APC, the APC logo, PowerNet, and InfraStruXure are trademarks of American Power Conversion Corporation. All other trademarks, product names, and corporate names are the property of their respective owners and are used for informational purposes only.

990-3245-001

11/2007

