

Environmental Monitoring Probe (EMP) Installation and Connection Quick Start

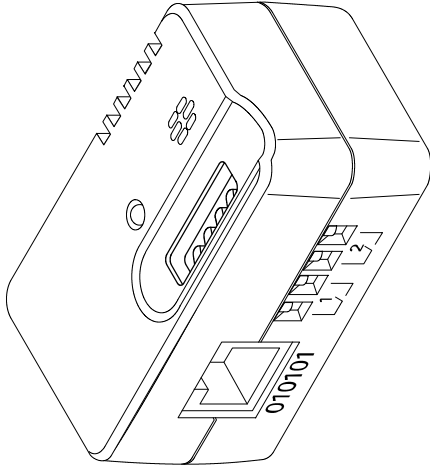

EATON
Powering Business Worldwide

Installation and Connection Quick Start

The optional environmental monitoring probe (EMP) is a connectivity device that enables you to collect temperature and humidity readings in the rack environment and monitor the environmental data remotely. You can also collect and retrieve the status of two contact devices.

You can monitor readings locally using the onboard LCD menu display, or remotely using a Telnet connection or a standard Web browser. This provides greater power management control and flexible monitoring options.

The EMP device is delivered with a screw, Velcro fasteners, tie wraps, and a connection cable. You can install the device anywhere on the rack. To attach the EMP, use either the Velcro fasteners or mount the EMP on the supplied screw. The EMP also has a universal slot on the back for mounting easily on a screw and in any direction.

For detailed information about using the EMP, refer to the Eaton Advanced Enclosure Power Distribution Unit (ePDU) User's Guide. Access the User's Guide at <http://www.ePDU.com/countries.php>.

Features

The environmental monitoring probe has the following features:

- The hot-swap feature simplifies installation by enabling you to install the probe safely without turning off power to the ePDU or to the loads that are connected to it.
- The EMP monitors temperature and humidity information of any environment that you want to protect your critical equipment. The EMP measures temperatures from 0°C to 70°C with an accuracy of $\pm 2^{\circ}\text{C}$.
- The EMP measures relative humidity from 10% to 90% with an accuracy of $\pm 5\%$.
- It can be located away from the ePDU with a CAT5 network cable up to 20 m (65.6 ft) long.
- The EMP monitors the status of the two user-provided contact devices.
- Temperature, humidity, and contact closure status can be displayed through a Web browser, a Serial interface, or an onboard LCD interface.
- User-selectable alarm thresholds enable you to define acceptable temperature or humidity limits.
- E-mail notification through Simple Mail Transfer Protocol (SMTP), using e-mail client software when acceptable alarm limits are exceeded or contact status changes.
- Changes in external contact status are logged in the ePDU event history log.
- When temperature and humidity values exceed user-selectable limits, the event is logged in the ePDU event history log.

 **DANGER:** Electrical current from power, telephone, and communication cables is hazardous. Do not connect or disconnect any cables or perform installation, maintenance, or reconfiguration of this product during an electrical storm.

 **DANGER:** When possible, use one hand only to connect or disconnect signal cables.

 **DANGER:** Never turn on any equipment when there is evidence of fire, water, or structural damage.

 **DANGER:** Disconnect the attached power cords, telecommunications systems, networks, and modems before you open the device covers, unless instructed otherwise in the installation and configuration procedures.

 **CAUTION:** When possible, use one hand only to connect or disconnect signal cables.

 **CAUTION:** Never turn on any equipment when there is evidence of fire, water, or structural damage.

 **CAUTION:** Disconnect the attached power cords, telecommunications systems, networks, and modems before you open the device covers, unless instructed otherwise in the installation and configuration procedures.

Unpacking and Inspecting the Equipment

The EMP is an optional accessory that is packaged separately from the ePDU. Use proper lifting and carrying techniques when unpacking and moving the EMP packing carton and components.

Inspect the product before installation. If the product is damaged in any way, see the Service and Support section for more information.

Service and Support

For questions or problems, please call your local distributor or the Eaton Customer Support Center at one of the following telephone numbers and ask for an ePDU technical representative.

United States: **1.800.356.5737**

All other countries: **Contact your local service representative.**

Please have the following information ready when you call the Eaton Customer Support Center: Model number, serial number, symptoms of failure or problem, customer return address, and contact information. If repair is required, you will be given a Returned Material Authorization (RMA) Number. This number must appear on the outside of the package and on the Bill of Lading (if applicable). Use the original packaging or request packaging from the Eaton Customer Support Center or distributor. Units damaged in shipment as a result of improper packaging are not covered under warranty. A replacement unit will be shipped, freight prepaid for all units under warranty.

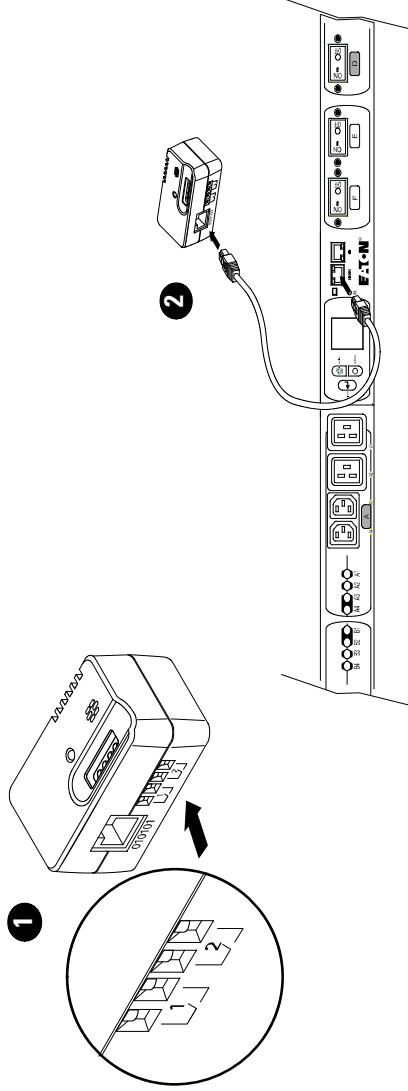

Connecting the Optional EMP to the ePDU

You can install the EMP either before or after ePDU installation and startup. An EMP can be installed without turning off power to the ePDU or the devices connected to it.

To install the optional EMP:

- 1 Locate the EMP (purchased separately).
- 2 If you plan to monitor one or two external contact devices, connect the external contact closure inputs to the screw terminals on the EMP.
-  **NOTE:** External contact devices can be normally open or normally closed.
- 3 Connect the first external contact device between pin number 1 and pin number two (above label 1; see Figure 1). Connect the second external contact device between pin number 3 and pin number 4 (above label 2; see Figure 1) as follows:

Device	Pin Number	Normally Open	Normally Closed
Device 1 Connection	1	Contact 1 returns	Normally Closed
	2	Contact 1 signal inputs	Normally Open
Device 2 Connection	3	Contact 2 returns	Normally Closed
	4	Contact 2 signal inputs	Normally Open

- 4 Locate the Ethernet cable (supplied). Connect one end of the cable to the RJ-45 connector on the EMP, then connect the other end of the cable to the RS-232 connector on the ePDU (see Figure 2).

-  **NOTE:** If the supplied cable is not long enough for your installation, you can use another Ethernet cable up to a length of 20m (65.6 ft).

- 5 Use either the supplied screw or Velcro straps to mount the EMP in a convenient location anywhere on the rack as follows:
 - To mount the ePDU within the enclosure environment, attach one Velcro fastener to the ePDU and the other Velcro fastener to an enclosure rail post. Press the two Velcro strips together to secure the EMP to the rail post.
 - The EMP has a universal slot on the rear for easy mounting on a screw in any direction. Use the supplied screw to wall mount the EMP.
- 6 Use the supplied tie wraps to secure the Ethernet cable out of the way as needed.
- 7 When you are ready to configure EMP thresholds, start up the ePDU.

-  **NOTE:** On startup, the ePDU automatically recognizes the EMP.

Refer to the Network Connections Quick Start (packaged with the ePDU) for initial network configuration information. For more detailed information, refer to the *Eaton Advanced Enclosure Power Distribution Unit (ePDU) Firmware User's Guide* at <http://www.ePDU.com/countries.php>.

Information in this document is subject to change without notice. © 2011 Eaton Corporation Inc. All rights reserved.

Reproduction in any manner whatsoever without the written permission of Eaton Corporation is strictly forbidden. Eaton and the Eaton logo are trademarks of Eaton Corporation. Eaton disclaims proprietary interest in the marks and names of others. 05/2011 • P-164000046 Rev 1

Les informations de ce document sont susceptibles d'être modifiées sans préavis. © 2011 Eaton Corporation Inc. Tous droits réservés.

La reproduction de ce document de quelque manière que ce soit sans l'autorisation écrite de Eaton Corporation est strictement interdite. Eaton et le logo Eaton sont des marques commerciales de Eaton Corporation. Eaton nie tout intérêt propriétaire dans les marques commerciales et les noms commerciaux ne lui appartenant pas. 05/2011 • P-164000046

Die Angaben in diesem Dokument unterliegen unangekündigten Änderungen. © 2011 Eaton Corporation Inc. Alle Rechte vorbehalten.

Eine Vervielfältigung, gleich welcher Art, ist ohne schriftliche Genehmigung von Eaton Corporation strengstens untersagt. Bei Eaton und dem Eaton-Logo handelt es sich um Marken von Eaton Corporation. Eaton verzichtet auf die Beteiligung am Urheberrecht an den Marken und Namen Dritter. 05/2011 • P-164000046 Änd 1

La información de este documento se encuentra sujeta a cambios sin previo aviso. © 2011 Eaton Corporation Inc. Todos los derechos reservados.

Queda estrictamente prohibida cualquier forma de reproducción sin el previo consentimiento de Eaton Corporation por escrito. Eaton y el logo de Eaton son marcas comerciales de Eaton Corporation. Eaton niega el interés en el derecho de propiedad de las marcas y nombres comerciales de terceros. 05/2011 • P-164000046 Rev 1