

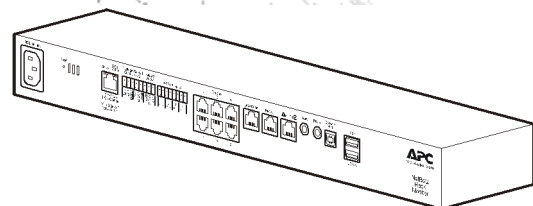

Installation and Quick Configuration Manual

NetBotz[®] Rack Monitor 450/550/570

NBRK0450
NBRK0550
NBRK0570





This manual is available in English on the enclosed CD.

Dieses Handbuch ist in Deutsch auf der beiliegenden CD-ROM verfügbar.

Este manual está disponible en español en el CD-ROM adjunto.

Ce manuel est disponible en français sur le CD-ROM ci-inclus.

Questo manuale è disponibile in italiano nel CD-ROM allegato.

本マニュアルの日本語版は同梱の CD-ROM からご覧になれます。

O manual em Português está disponível no CD-ROM em anexo.

Инструкция по использованию на русском языке прилагается на диске (CD).

您可以从包含的 CD 上获得本手册的中文版本。

동봉된 CD 안에 한국어 매뉴얼이 있습니다 .

Contents

- Introduction 1**
 - Product Description 1
 - Document Overview 1
 - Related Documents 1
 - Additional Options 1
 - InfraStruxure-certified 2

- Physical Description 3**

- Inventory 5**

- Installation 6**
 - Install the Appliance 6
 - Rack-mount installation 7
 - Power cord and network cable connections 8
 - Connect Sensors to Sensor Ports 9
 - Connect an Alarm Beacon and Other Optional Devices 10
 - Connect Sensors and Sensor Pods to A-Link Ports 11

- Initial Configuration 13**
 - Overview 13
 - Obtain network settings using DHCP 13
 - Configure network settings using the serial configuration utility 14
 - Install a wireless network device 15
 - The NetBotz Configuration Wizard 16

Access an Appliance	16
Overview	16
Administrator account user ID and password	16
Root account user ID and password	17
Lost password recovery	17
Web Client	18
Advanced View	18
NetBotz Quick Configuration	19
Configure appliance settings	19
Configure alert actions	20
Upgrade Options	21
Software Feature Upgrades	21
Hardware Upgrades	21
Add pods to your appliance	22
Connect a wireless sensor network	24
Connect a USB modem	26
Connect a USB digital I/O device	26
Connect an APC Switched Rack PDU	27
Connect external sensors	27
Disposal	28
Clean the NetBotz 450/550/570	28
Specifications	29
Sensor Specifications	30
Warranty	31
Two-Year Factory Warranty	31
Terms of warranty	31
Non-transferable warranty	31
Exclusions	31
Warranty claims	32

Radio Frequency Interference35

- USA—FCC35
- Canada—ICES35
- Japan—VCCI35
- Taiwan—BSMI35
- Australia and New Zealand35
- European Union35

Introduction

Product Description

The Schneider Electric NetBotz[®] Rack Monitor 570, Rack Monitor 550 or Rack Monitor 450 functions as the central hardware appliance for a NetBotz security and environmental monitoring system. The rack-mountable appliance includes multiple ports for connecting APC environmental sensors and other third-party sensors. The appliances include additional ports that provide power to or allow control over other devices. With a NetBotz 570, 550, or 450, you can increase the space monitored. With a NetBotz 570 or 550, you can add up to twelve NetBotz sensor pods. With a NetBotz 450, you can add up to two NetBotz sensor pods.

Document Overview

The *NetBotz Rack Monitor 450/550/570 Installation and Quick Configuration Manual* describes how to install a NetBotz Rack Monitor 450, 550, or 570, how to connect devices to the appliances, and how to configure network settings. After performing the configuration procedures in this manual, you can access your system through its software interface, perform additional configuration tasks, and begin monitoring the environment.

Related Documents

Unless otherwise noted, the following documentation is available on the CD provided with the device or on the applicable product page on the APC Web site, www.apc.com. To quickly find a product page, enter the product name or part number in the Search field.

NetBotz Appliance User's Guide – Includes all details for using, managing, and configuring a NetBotz system with one of the following appliances: NetBotz Room Monitor 355 (NBWL0355, NBWL0356), NetBotz Rack Monitor 450 (NBRK0450), NetBotz Room Monitor 455 (NBWL0455, NBWL0456), NetBotz Rack Monitor 550 (NBRK0550), or NetBotz Rack Monitor 570 (NBRK0570).

Additional Options

The following options are available for the appliance. For more information about any of the options, contact your APC representative or the distributor from whom you purchased your APC product.

- NetBotz Camera Pod 160 (NBPD0160)
- NetBotz Rack Sensor Pod 150 (NBPD0150)
- NetBotz Room Sensor Pod 155 (NBPD0155)
- Temperature Sensor (AP9335T)
- Temperature/Humidity Sensor (AP9335TH)
- Temperature Sensor with Digital Display (AP9520T)
- Temperature/Humidity Sensor with Digital Display (AP9520TH)
- Alarm Beacon (AP9324)
- NetBotz Spot Fluid Sensor (NBES0301)

- NetBotz Door Switch Sensor for Rooms or Third Party Racks (NBES0302)
- NetBotz Door Switch Sensor for APC Racks (NBES0303)
- NetBotz Dry Contact Cable (NBES0304)
- NetBotz 0-5 V Sensor Cable (NBES0305)
- NetBotz Vibration Sensor (NBES0306)
- NetBotz Smoke Sensor (NBES0307)
- NetBotz Rope Leak Sensor (NBES0308)
- NetBotz Rope Leak Extension (NBES0309)
- NetBotz Particle Sensor PS100 (NBES0201)
- NetBotz USB-to-Serial Cable (NBAC0226)
- Power Supply 100-230 VAC/24 VDC (AP9505i)
- NetBotz 4-20mA Sensor Pod (NBPD0129)
- NetBotz CCTV Adapter 120 with USB Cable (NBPD0123)
- NetBotz Sensor Pod 120 (NBPD0122)
- NetBotz Camera Pod 120 (NBPD0121)
- NetBotz Rack Access Pod 170 (NBPD0170) (for NBRK0550 and NBRK0570 only)
- NetBotz Rack Access Electronic Handle (NBHN0170) (for NBRK0550 and NBRK0570 only)
- NetBotz Wireless Sensor Pod 180 (NBPD180)
- NetBotz USB Coordinator & Router (NBWC100U)
- NetBotz Wireless Temperature Sensor (NBWS100T and NBWS100H)

InfraStruxure-certified

This product is certified for use in APC InfraStruxure[®] systems.

Physical Description

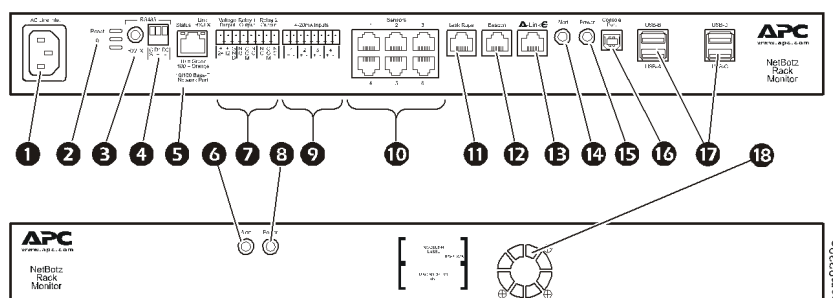

Item	Description
❶ AC line inlet	Provides for the input power connection; see “Specifications” on page 29 for voltage information.
❷ Reset switch	Resets the appliance.
❸ Port activity LED	Flashes green when the RS485 port is receiving. Only available on the NBRK0570 appliance.
❹ RS485 port	Provides for a Modbus connection. Only available on the NBRK0570 appliance.
❺ 10/100 Base-T Network Port	Provides for a 10/100 Base-T network connection. Status and link LEDs indicate network traffic: <ul style="list-style-type: none"> • Status LED—blinks orange and green at start-up; indicates the status of the network connection (solid green—IP address established; blinking green—attempting to obtain an IP address). • Link LED—blinks to indicate network traffic (green—connected at 10 Mbps; orange—connected at 100 Mbps).
❻ Alert LED	Indicates the alert status of the system. When more than one alert exists, the most severe will be indicated. <ul style="list-style-type: none"> • Flashing once every eight seconds—Informational • Flashing once every four seconds—Warning • Flashing once every two seconds—Error • Flashing once every second—Critical • Flashing twice per second—Failure
❼ Voltage Output	Provides 12 VDC or 24 VDC (75 mA) to one connected device.
Relay Output Ports 1, 2	Used for connecting relay-controlled external devices. Provides 24 VDC (100mA) each.
❽ Power LED	Indicates whether the unit is receiving power (green—receiving power; dark—not receiving power).
❾ 4-20 mA Inputs	Provides 24 VDC for connecting third-party sensors with an input current range from 4 to 20 mA.
❿ Sensor ports	Used for connecting APC sensors, third-party dry-contact sensors, and standard third-party 0-5 V sensors. (See “Additional Options” on page 1 for details on APC sensor options.) Third-party dry-contact state sensors require the NetBotz Dry Contact Cable (NBES0304). Standard third-party 0-5 V sensors require the NetBotz 0-5 V Sensor Cable (NBES0305). NBRK0450/550 - 5/24 VDC (50mA). NBRK0570 - 5/24 VDC (200mA).
⓫ Leak Rope port	Used for connecting a NetBotz Rope Leak Sensor (NBES0308)
⓬ Beacon port	Used for connecting an Alarm Beacon (AP9324).

Item	Description
13 A-Link port	Used for cascading NetBotz sensor pods and temperature and humidity sensors with digital displays. Provides communications and power to the connected devices over standard CAT-5 cabling with straight-through wiring. For details, see “Connect Sensors and Sensor Pods to A-Link Ports” on page 11.
14 Alert LED	Same as item 4 above.
15 Power LED	Indicates whether the unit is receiving power (green—receiving power; dark—not receiving power).
16 Console Port	Used to connect a console to the appliance. Enable the USB-to-serial converter support (FTDI) in your operating system.
17 USB Type A ports (2 or 4)	Used to connect USB devices to the appliance. The NBRK0550 and NBRK0450 have two USB ports, while the NBRK0570 has four.
18 Exhaust fan	Exhausts hot air from the NBRK0570. Not present on the NBRK550 or NBRK450.

Inventory

Inspect the contents of the package to ensure that the parts included match those shown below. Report missing or damaged contents to APC or your APC reseller. However, if damage was due to shipping, immediately report the damage to the shipping agent.



The shipping and packaging materials are recyclable. Please save them for later use or dispose of them appropriately.

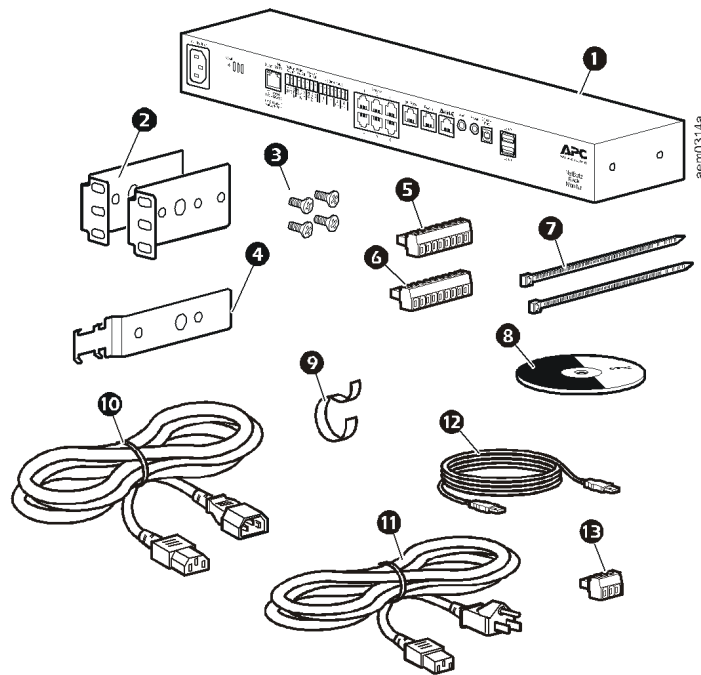

Item	Description
1	NetBotz Rack Monitor 450, Rack Monitor 550 or Rack Monitor 570
2	Brackets for a standard 19-in rack
3	M4 x 8 Phillips flat-head screws
4	Power cord retainer bracket
5	8-position terminal block plug
6	9-position terminal block plug
7	203-mm (8-in) tie wraps
8	<i>NetBotz Appliance Utility CD</i>
9	203-mm (8-in) hook and loop cable strap
10	1.8-m (6-ft) IEC-320-C13 to IEC-320-C14 power cord
11	1.8-m (6-ft) NEMA 5-15P to IEC-320-C13 power cord
12	5-m (16.4-ft) USB cable
13	3-position terminal block plug
	Temperature/Humidity Sensor (AP9335TH)—not shown

Installation

Install the Appliance

Install the appliance in the front or the rear of the rack or enclosure using the rack-mount procedure, which requires 1 U of rack space. When installing the appliance, take into consideration the following:



Caution: Only connect approved devices to ports on the appliance as directed in this manual. Plugging in other devices may result in equipment damage.



Note: Install the appliance in an environment compatible with the maximum ambient temperature (T_{ma}) specified in “Specifications” on page 29. Appliances installed in a closed or multi-unit rack assembly can experience a greater operating ambient temperature than the ambient room temperature.



Note: Install the appliance in a way that allows sufficient airflow for safe operation.



Note: When you install the appliance in the rack, be sure that you do not create a hazardous condition due to uneven mechanical loading. For example, do not use the appliance as a shelf.

Rack-mount installation

1. Choose a location for the appliance in the front or rear of the rack. The appliance occupies one U-space. A notched hole or a number on the rack vertical rail denotes the middle of a U-space.

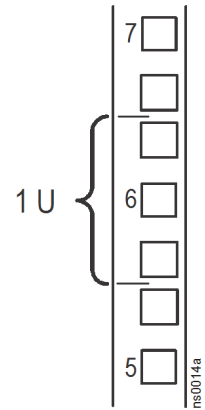

Caution: To avoid equipment damage, use only the hardware provided when installing the brackets.

2. Install the brackets (**2** and **3**), including the power cord retainer bracket, on the end nearest the AC Line Inlet.

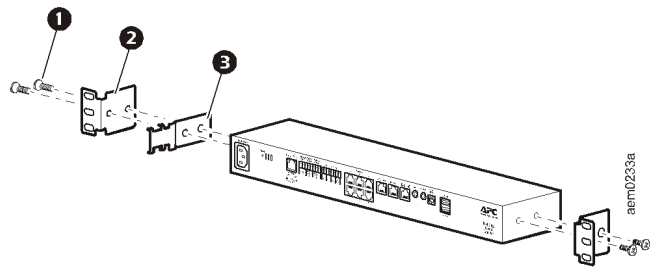

1 M4 x 8 Phillips flat-head screws

2 Bracket

3 Power cord retainer bracket

3. Secure the appliance to the rack, using cage nuts and screws (provided with the rack).

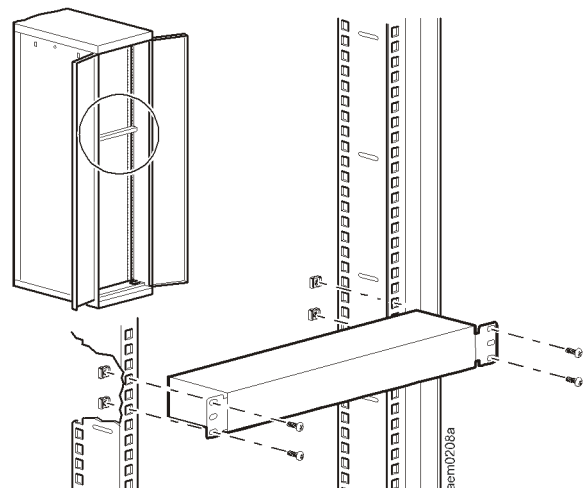

Power cord and network cable connections



Caution: Before you energize the appliance, review the electrical specifications on page 29 to avoid overloading the circuit.

Caution: Make sure you properly ground the appliance by plugging the power cord directly into a wall outlet or by verifying the ground path if using a power strip.



Note: The power cords provided are to be used only with APC NetBotz products.

1. Connect the appropriate power cord to the AC Line Inlet of the appliance.
2. Secure the power cord to the power cord retainer bracket using the tie wraps.
3. Connect a network cable to the 10/100 Base-T Network Port on the appliance.
4. Plug the power cord into a power source.
5. Use the hook and loop cable strap to secure the cables.

Connect Sensors to Sensor Ports

This procedure applies to the following sensors, which are supported by the appliance and connect to the sensor ports:

- Temperature Sensor (AP9335T)
- Temperature/Humidity Sensor (AP9335TH)
- NetBotz Vibration Sensor (NBES0306)
- NetBotz Smoke Sensor (NBES0307)
- NetBotz Spot Fluid Sensor (NBES0301)
- NetBotz 0-5 V Sensor Cable (NBES0305)
- NetBotz Door Switch Sensor for APC Racks (NBES0303)
- NetBotz Door Switch Sensor for Rooms or Third Party Racks (NBES0302)
- NetBotz Dry Contact Cable (NBES0304)



For sensors that connect to A-Link ports (Temperature Sensors with Digital Display [AP9520T] and Temperature/Humidity Sensors with Digital Display [AP9520TH]), see “Connect Sensors and Sensor Pods to A-Link Ports” on page 11.

Connect APC and third-party sensors to the six sensor ports labeled **Sensors** on the appliance.

- Third-party dry contact sensors require the NetBotz Dry Contact Cable (NBES0304). To connect a sensor to the cable, follow the instructions provided with the sensor and the instructions provided with the cable.
- Standard third-party 0-5 V sensors require the NetBotz 0-5 V Sensor Cable (NBES0305). To connect a sensor to the cable, follow the instructions provided with the sensor and the instructions provided with the cable.
- If a sensor cable is not long enough, use an RJ-45 coupling (provided with some sensors) and standard CAT-5 cabling to extend the cable up to 15 m (50 ft) for a Temperature/Humidity Sensor (AP9335TH) or a Temperature Sensor (AP9335T) and up to 30.5 m (100 ft) for all other supported sensors.

Below is a list of the different pod/sensor types and the number of devices each appliance can support.:

Pod/Sensor Type	Rack Monitor 570	Rack Monitor 550	Rack Monitor 450
Camera Pod 160	total of 4 pods	total of 4 pods*	total of 2 pods
Camera Pod 120			
CCTV Adapter Pod 120			
Sensor Pod 150	total of 12 pods	total of 12 pods	total of 2 pods
Sensor Pod 155			
Sensor Pod 120			
4-20 mA Input Pod 120			
Smoke Sensor	2	2	2
AP9520 Temp/Humidity Probe (A-Link)	8	8	8
* Installing four camera pods requires an external USB hub.			

Connect an Alarm Beacon and Other Optional Devices

1. Install an alarm beacon:
 - Install the alarm beacon in a visible position either on the roof of the rack or inside the rack.
 - Route the alarm beacon cable to the appliance. The alarm beacon cable may be extended to a maximum of 100 m (328 ft), using RJ-45 couplings and standard CAT-5 cables.
 - Connect the cable to the Alarm Beacon port.
2. Connect one device to the Voltage Output.

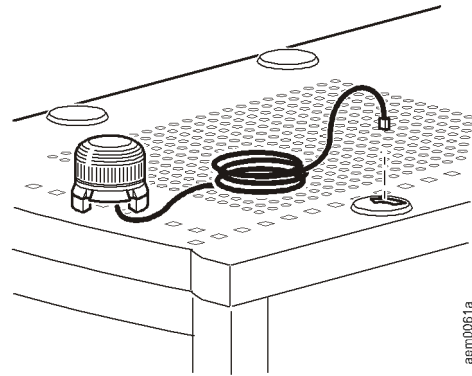

aern0061a



Caution: Relay Outputs can only be connected to Class 2 circuits.

3. Connect up to two devices to the Relay Outputs.
4. Connect a NetBotz Rope Leak Sensor to the Leak Rope port.

Connect Sensors and Sensor Pods to A-Link Ports

With a NetBotz 550 or NetBotz 570, you can cascade up to a combined total of twelve NetBotz Rack Sensor Pod 150s (NBPD0150) and NetBotz Room Sensor Pod 155s (NBPD0155) plus up to a combined total of eight Temperature Sensors with Digital Display (AP9520T) and Temperature/Humidity Sensors with Digital Display (AP9520TH). In addition, you can cascade up to a total of thirteen Rack Access Pod 170s.

With a NetBotz 450, you can cascade up to a combined total of two NetBotz Rack Sensor Pod 150s (NBPD0150) and NetBotz Room Sensor Pod 155s (NBPD0155), plus up to a combined total of eight Temperature Sensors with Digital Display (AP9520T) and Temperature/Humidity Sensors with Digital Display (AP9520TH).

You cannot cascade appliances. Use one appliance per system. A-Link is an APC proprietary CAN (Controller Area Network) bus. Devices compatible with A-Link are not Ethernet devices and cannot coexist on an Ethernet bus with other networking devices, such as hubs and switches.

Before performing this procedure, follow the installation instructions provided with the devices you are cascading. If you cascade more than ten sensor pods, be sure you have a supplemental power supply (Power Supply 100-230 VAC/24 VDC—AP9505i) to connect to your system as directed in this procedure. If you cascade more than four Rack Access Pod 170s, you will need an additional power supply for every four Rack Access Pods. The NetBotz 570 does not require an external power supply.

1. Connect sensors and sensor pods to the appliance as shown.
 - Use CAT-5 (or equivalent) Ethernet patch cables (2). **Caution: Do not use crossover cables.**
 - Connect to **in** and **out** ports as shown.
 - The maximum combined length of all A-Link cables must not exceed 1000 m (3,280 ft).
2. Plug an A-Link terminator into the unused A-Link port (3).

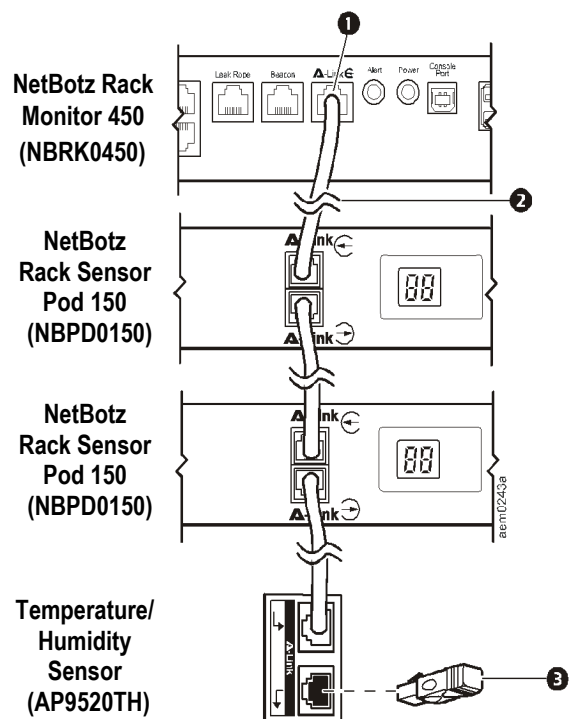



Caution: The first time a sensor pod receives power, it obtains a unique identification address for communication over the A-Link bus. To avoid communication problems, you must complete steps 1 and 2 before you connect a supplemental power supply.

3. With a Rack Monitor 450 or 550, if you have cascaded ten or more devices, connect one supplemental power supply (AP9505i) to the 24 VDC Input jack of the Rack Sensor Pod 150 or the Room Sensor Pod 155 in or closest to the eleventh position.

Initial Configuration



Note: Disregard the procedures in this section if you have an APC InfraStruxure Central server as part of your system. See the documentation for your InfraStruxure device for more information.

Overview

You must configure the following TCP/IP settings before the appliance can operate on a network:

- IP address of the appliance
- Subnet mask
- Default gateway



Note: If a default gateway is unavailable, use the IP address of a computer that is located on the same subnet as the appliance and that is usually running. The appliance uses the default gateway to test the network when traffic is very light.

Obtain network settings using DHCP

By default, your appliance obtains its network settings using DHCP. When you connect the appliance to your network and apply power to the unit, it automatically attempts to contact a DHCP server. The appliance waits 30 seconds for a response. If the DHCP server is configured to provide a hostname, the appliance requests either its configured hostname or 'netbotzxxxxxx' (where xxxxxx is the last 6 digits of the MAC address of the appliance) as a hostname associated with the IP address granted by the DHCP server. This enables you to use a Web browser to connect to the appliance using the address **http://netbotzxxxxxx** without any additional configuration. The appliance also requests DNS server addresses, a DNS domain, SMTP server addresses, and NTP server addresses from the DHCP server.

Install the serial configuration utility and other programs. The NetBotz Serial Configuration Utility is a Java[®]-based application that configures the network settings on your NetBotz appliance. Use the *NetBotz Appliance Utility CD* to install the Serial Configuration Utility (Windows systems only), as well as the Advanced View (the monitoring and management console for your NetBotz appliance) and the Java Runtime Environment (JRE) on your system.



Note: The Java Runtime Environment used by the Advanced View application is always installed, regardless of whether the installation target already has a suitable JRE installed.

- **Microsoft[®] Windows[®] Systems:** To install the applications and the JRE on a computer running Windows XP SP1 or SP2, Windows 2000, Windows Vista, or Windows 7, place the *NetBotz Appliance Utility CD* in the CD drive of the computer that you will use to configure and manage your appliance. The NetBotz Installer starts automatically. If you have disabled Autorun on your computer, click **Start > Run**, type `x:\av\windows\install.exe` in the **Open** field (where `x` is the drive letter assigned to your CD drive) and click **OK**. Follow the prompts to complete the installation of your software.
- **Linux Systems:** To install the applications and the JRE on a computer running Red Hat[®] Enterprise Linux[®] 4 or 5, or Fedora[™] Core 11 or 12, place the *NetBotz Appliance Utility CD* in the CD drive of the computer that you will use to configure and manage your NetBotz appliance. Mount the drive if necessary. Run `install.bin` from the Linux subdirectory on the CD. For example, if you are using Linux and you mounted the CD drive as `/mnt/cdrom`, execute the following command:

```
sh /mnt/cdrom/linux/install.bin
```

Follow the prompts to complete the installation of your software.

Configure network settings using the serial configuration utility

To configure your appliance using the Serial Configuration Utility:

1. Click **Start > Programs > NetBotz > Serial Configuration > Serial Configuration Utility** to start the Serial Configuration Utility.
2. Connect one end of a USB cable to your computer and the other end of the cable to the Console port on the NetBotz appliance.
3. Plug the power cord provided with your NetBotz appliance into a wall outlet, and then connect it to the AC line inlet.



Note: This power cord is to be used only with APC NetBotz products.

The green Power LED illuminates immediately after you apply power to the appliance. The unit can take up to two minutes to initialize, depending on appliance configuration. The red Alert LED illuminates when the appliance detects an alert condition. Click **Next** to continue.

4. The Serial Configuration Utility automatically scans your system COM ports to determine if a NetBotz appliance is connected to the network. If a NetBotz appliance is discovered, the appliance is listed in the Device column of the window. Select the radio button for the appliance to configure and click **Next** to continue.



Note: If the COM port associated with the port to which your USB cable is connected is currently in use by another application, the message beside the COM port in the **Owner** column indicates that the port is not available. To correct this, close the application that is using the COM port and click **Scan Serial Ports**.

5. The Root Password window appears. Enter the administrator account password for this appliance (**apc**, by default) and click **OK**.
6. Specify whether to use DHCP to specify the network settings of your appliance. Click **Yes** or **No**, and click **Next** to continue.
7. The utility scans the appliance and displays the network settings stored on the appliance. The network settings are divided into Ethernet Card Settings and DNS Settings.
8. Specify the Ethernet Card settings.
 - To use network settings assigned by a DHCP server, select **Configure automatically via DHCP**.
 - To specify network settings for use by this appliance, select **Configure using these settings** and provide an IP address, subnet mask, and gateway address for the appliance. Specify a NAT proxy name or IP address to be used by a NAT Proxy server in your network to allow users to connect to the appliance from outside the firewall. You can also specify speed and duplex settings for use by this interface, or use the default setting, **Auto Negotiate**.
9. Specify the DNS Settings.
 - To use DNS Settings provided by your DHCP server, check **Use DHCP DNS Settings**.
 - To specify DNS Settings for this appliance manually, clear the **Use DHCP DNS Settings** checkbox and provide the domain and DNS server information.
10. Click **Next** to save your configuration settings. Click **Finish** to close the Serial Configuration Utility.
11. Test the IP connection of the NetBotz appliance. Start your Web browser and type the IP address of the appliance into the address field. Press **Enter**. If the NetBotz appliance is online and properly configured, the web client displays in the browser window.

Install a wireless network device

You can install a third-party wireless network device by connecting it to the Ethernet port on the appliance using an Ethernet cable. APC currently supports the D-Link DWL-G820, a wireless Ethernet bridge.



To install and configure a third-party wireless network device, see the instructions provided with that device.

The NetBotz Configuration Wizard

Use the Configuration Wizard to configure the following settings on your appliance:

- Domain Name Server Settings
- Clock and Calendar Settings
- Region Settings
- Administrator User ID and Password
- E-Mail Settings
- E-Mail Alert Notification Recipients

The Configuration Wizard downloads the latest available version of BotzWare to your appliance.

When you finish configuring your appliance with the Wizard, your appliance monitors your environment for lack of adequate air flow and for changes in temperature and humidity and detects motion in the area in which the camera is located. Alert conditions detected by any of these sensors generate an e-mail to send to a specified e-mail address.

The Configuration Wizard runs each time you use the Advanced View with your NetBotz appliance until you complete all of the steps in the Wizard or check **Don't Show Configuration Wizard Next Time**. You can run the Wizard again by selecting **Configuration Wizard** from the Advanced View **Tools** drop-down list.

Access an Appliance

Overview

After the appliance is running on your network, you can access the configured appliance through the web client or the Advanced View.

Administrator account user ID and password

Your NetBotz appliance has a pre-configured Administrator account. The User ID and Password for this account are:

- **User ID:** apc
- **Password:** apc



Note: To increase security, be sure to use the Advanced View *Users* task to change the default User ID and Password for the Administrator account.

Root account user ID and password

Your NetBotz appliance has a pre-configured root account. The root account is used only for appliance communications that are performed using the USB Console Port, e.g., when you use the Serial Configuration Utility to specify network settings. The default User ID and Password for this account are:

- **User ID:** root
- **Password:** apc



Note: You cannot change the root account User ID. To increase security, use the Advanced View *Change Root Password* Tool to change the default root account password.

Lost password recovery

To recover from a lost password:

1. Locate the reset switch on the rear of the appliance, to the right of the AC Line Inlet port.
2. Use a thin wire such as a paper clip to press the reset switch for 10 seconds. This causes the system to restart.
3. Once the system restarts, log in within two minutes using the default login values:
 - For Advanced View:
 - **User ID:** apc
 - **Password:** apc
 - For the console:
 - **User ID:** root
 - **Password:** apc



Note: If you do not log in within two minutes after holding down the reset switch, you must repeat the procedure.

4. After you log in, change the password to increase security.

Web Client

The NetBotz web client provides a real-time overview of alerts and device details, including sensor readings and images captured by camera pods, for a NetBotz appliance running version 4.2 and above.



Note: For advanced appliance configuration and system administration, use the NetBotz Advanced View. Advanced View is not supported on mobile devices.

For a list of supported Web browsers and versions, see the release notes available on the *Utility CD*.

Advanced View

Use the Advanced View to view sensor data, camera images, and other appliance data in a custom Java application. You can also use the Advanced View to generate relay output actions and configure all appliance features. The Advanced View is a stand-alone application that must be installed on a supported network-attached computer.



For more information on the web client or the Advanced View, see the *NetBotz Appliance User's Guide*.

NetBotz Quick Configuration

Once you configure, install, and apply power to your appliance, use the Advanced View to perform the following procedures.

- **Configure Appliance Settings:** Configure the appliance Clock, DNS, Region, Network Interface (hostname, NAT proxy, and speed and duplex settings), E-mail Servers, and Proxy settings.
- **Configure Alert Actions:** Configure the Play Audio Alert and Primary E-mail Notification alert actions.

Configure appliance settings

Open the Advanced View and perform the following Appliance Settings tasks. The icons associated with each task are located in the Configuration pane, in the Appliance Settings region.

1. Set the Clock settings. By default, your appliance synchronizes the system clock with the default NTP servers. If network access to these servers is not permitted, double-click on the **Clock** icon and specify your NTP server address or manually specify clock settings.
2. Set DNS settings. Double-click the **DNS** icon and specify the DNS Domain and at least one DNS Server address.
3. Set the Region settings. Double-click the **Region** icon and set Locale and Time Zone. The default settings are US and Central Standard Time.
4. Specify a hostname for your appliance. Double-click on **Network Interfaces** and specify a hostname for your appliance. Optionally, specify a NAT proxy name or IP address to be used by a NAT Proxy server in your network to allow users connect to the appliance from outside the firewall. You can also specify speed and duplex settings for use by this interface, or use the default setting, **Auto Negotiate**.
5. Assign a unique User ID and Password to the Administrator account. By default, User ID and Password for the Administrator account are both **apc**. To increase security, double-click the **Users** icon, double-click **NetBotz Admin Account**, and specify a unique User ID and password for the administrator account.
6. Set your E-mail Server settings. This is the e-mail server that your appliance uses to deliver e-mail alert notifications. Double-click the **E-mail Servers** icon, and configure the following settings:
 - a. (Optional) Provide a **From** address.
 - b. In the **SMTP server** field, type the hostname or IP address of your SMTP server (for example, mail.yourcompany.com).
 - c. If necessary, specify a **Port** value (25, by default).
 - d. Select an **SSL option** for authentication and certificate verification. Check with your network administrator for further assistance.
 - e. Click **Test E-mail Server**, type in your e-mail address, and click **OK**. An e-mail is sent to your address when an alert is detected. Confirm that you received the test e-mail and continue.
7. If your network uses an HTTP or Socks proxy server, double-click the **Proxy** icon and specify your Proxy settings. If you are unsure whether you use an HTTP or Socks proxy, check with your network administrator.

Configure alert actions

You can configure your appliance to play audio alert notifications through the headphone/speaker jack on your Camera Pod 160 or Sensor Pod 120 or to send an e-mail alert notification to your e-mail address when sensor thresholds are violated.

Open the Advanced View and perform the following Pod/Alerts Settings tasks. The icons associated with each task are located in the Configuration pane, in the Pod/Alerts Settings region.

1. Open the Alert Actions task. Double-click the **Alert Actions** icon to open the Alert Action Configuration window.
2. Click **Add...** to open the Select Alert Action window, select **Play Audio Alert** and click **OK** to open the Add Alert Action window.
3. In the **Alert Action Name** field, type a name for this alert action (for example, Play Audio Alert).
4. Select your Camera Pod from the **Output Device** drop box. Optionally, adjust the **Volume%** setting.
5. Click **OK** to close the Add Alert Action window and continue. Your newly created alert action is included in the list of Alert Actions.
6. Select **Primary E-mail Notification** from the list of defined alert actions and click **Edit**.
7. Check **Include a sound clip with the alert**. This ensures that any alert e-mailed to you includes a sound clip with any camera images that are delivered. You can disable this option later, if the file size of alert notifications is too large.
8. Click **Add...**, type your e-mail address in the Add E-mail Address window, and click **OK**.
9. Click **OK** to close the Edit Alert Action window and continue.
10. Click **OK** to close the Alert Action Configuration window.

Upgrade Options

Software Feature Upgrades

The BotzWare on your appliance can be upgraded using the Upgrade task in the Advanced View. The following software packs can be added to your appliance.

- Advanced Software Pack, which includes the following features:
 - Block out masking for camera images
 - Digitally signed clips
 - Enhanced audio features
 - Detailed appliance location information
 - Increased number of definable users and user capabilities



Note: The features of this pack are standard on the NetBotz 570 and 550.

- 5 Node Scanner/IPMI Pack, which provide IPMI and SNMP scanner integration



Note: When you upgrade your appliance, the connected pods are automatically updated. If your network includes more than one appliance, you must perform the upgrade on all appliances. Valid data is not available during the upgrade.

Hardware Upgrades

You can upgrade your NetBotz appliance hardware in the following ways:

- Add Camera Pod 160s, Sensor Pod 150s, Sensor Pod 155s, Rack Access Pods 170s (Netbotz 570 and Netbotz 550 only), NetBotz Wireless Sensor Pod 180, and CCTV Adapter Pod 120s to your NetBotz appliance.
- Add a wireless sensor network to your appliance using the NetBotz Wireless Sensor 180, NetBotz USB Coordinator & Router, and the NetBotz Wireless Temperature Sensor.
- Add a supported USB modem to a USB port on your appliance.
- Add a supported USB digital I/O device to a USB port on your appliance.
- Add supported USB-to-serial port device on your appliance.



Note: The NetBotz Rack Monitor 570, NetBotz Rack Monitor 550, and the NetBotz Rack Monitor 450 support the NetBotz Sensor Pod 120 and the NetBotz Camera Pod 120.

Add pods to your appliance

The NetBotz Rack Monitor supports the following pods:

Pod Type	Rack Monitor 570	Rack Monitor 550	Rack Monitor 450
Camera Pod 160	total of 4 pods	total of 4 pods*	total of 2 pods
Camera Pod 120			
CCTV Adapter Pod 120			
Sensor Pod 150	total of 12 pods	total of 12 pods	total of 2 pods
Sensor Pod 155			
Sensor Pod 120			
4-20 mA Input Pod 120			
Smoke Sensor	2	2	2
AP9520 Temp/Humidity Probe (A-Link)	8	8	8
Rack Access Pod 170**	13	13	-
* Installing four camera pods requires an external USB hub.			
** Installing more than four Rack Access Pods requires a AP9505i power supply for every four pods after the first.			

Camera Pods, Sensor Pod 120s, and 4-20 mA Input Pod 120s can be connected directly to any of the appliance USB ports, or you can connect USB hubs to your appliance and then connect pods to the hub. Hubs can also be daisy chained, and pods can be connected to the daisy-chained hubs as long as the pod is no more than the fifth device in the chain.



Note: Due to power requirements, Camera Pod 160s, Sensor Pod 120s, CCTV Adapter Pod 120s, and 4-20 mA Input Pod 120s **must** be connected either directly to one of the USB ports at the appliance or to a USB hub receiving power from an external source. RS232-based sensors or devices can be connected to unpowered USB hubs.

As pods are connected to your appliance, they automatically appear in the Navigation pane in both the web client and Advanced View interfaces. Newly added pods are labeled by their pod type and their serial number.

- Once connected, CCTV Adapter Pod 120s require additional configuration before they can be used.

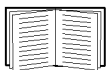

For more information, see “Install and configure a CCTV Adapter Pod 120” on page 23.

- If you connect a pod and then disconnect it, its entry in the Navigation pane in the Advanced View is grayed out. If you reconnect a disconnected pod, its Navigation pane entry becomes active again.

Install and configure a CCTV Adapter Pod 120. To install a CCTV Adapter Pod 120, connect your video source to the appropriate DIN, BNC, or RCA video input jack on the pod. Use the USB cable to connect your pod to your NetBotz appliance, or to a USB hub connected to the appliance. To reduce radio frequency noise and emissions from the USB cable, clamp one clamp-on ferrite onto the USB cable within 51-76 mm (2-3 in) of the end that connects to the pod, and the second clamp-on ferrite onto the USB cable within 51-76 mm (2-3 in) of the end that connects to your appliance or to the USB hub.

After you connect your CCTV Adapter Pod 120 and video source to your appliance, use the Advanced View to configure the pod.

To configure your pod:

1. Start the Advanced View. From the Appliance drop-down list, select the IP address of the appliance to which you have connected the CCTV Adapter Pod 120. Log in to the appliance using a user account that has administrator privileges. After you log in, confirm that the newly connected CCTV Adapter Pod 120 appears in the Navigation Pane. The default label for CCTV Adapter Pod 120s is *CCTV Video Pod serial*, where *serial* is the serial number of the pod.
2. Select the Configuration button and double-click the Camera Pods icon (located in the Pod/Sensor Settings portion of the Configuration pane).
3. In the Camera Pod Configuration pane, select the entry that corresponds to the CCTV Adapter Pod 120 and then click **Capture**.
4. The Camera Capture Settings window opens. In addition to the fields that are available when you use this window to configure Camera Pod 160s, one additional control is available when you configure a CCTV Adapter Pod 120:
 - **Video Format:** Used to specify the format in which video is transmitted by the video source. Available selections include: NTSC-M, NTSC-Japan, PAL-B, PAL-D, PAL-G, PAL-H, PAL-I, PAL-M, PAL-N Combination, and SECAM.
5. Use the controls in the Camera Capture Settings window to configure the camera and image capture settings for use with the pod. To see an example of an image capture using the currently selected **Video Format**, **Brightness**, **Contrast**, and **Image Quality** settings, click **Apply**. The sample image in the Capture window will be updated using the new values. When you are finished, click **OK** to save your changes to the appliance.

Your video source should now appear in the Advanced View Cameras pane. Once configured, you can use the video source in the same ways you use Camera Pod 160s.

Connect a wireless sensor network

You can connect a wireless sensor network to a NetBotz v4.4 appliance to monitor temperature and humidity using the NetBotz USB Coordinator & Router (NBWC100U), NetBotz Wireless Temperature Sensor (NBWS100T and NBWS100H), and NetBotz Wireless Sensor Pod 180 (NBPD0180). Additional sensors allow you to monitor rack door access and multiple temperature readings (Wireless Sensor Pod 180 only).

Each wireless sensor network must have one and only one Coordinator, connected to a USB Type A port on the NetBotz appliance. Routers are powered by an AC-USB adapter, not directly connected to the NetBotz appliance. End Devices are powered by batteries.

The following wireless devices can be configured as the **Coordinator** or as a **Router** on your wireless network:

Wireless Device	Range	Part Number
USB Coordinator & Router	100 ft - line of sight	NBWC100U
Wireless Sensor Pod 180	100 ft - line of sight	NBPD0180

The following wireless devices can be configured as an **End Device** on your wireless network:

Wireless Device	Range	Part Number
Wireless Temperature Sensor	100 ft - line of sight	NBWS100T NBWS100H
Wireless Sensor Pod 180	100 ft - line of sight	NBPD0180



Warning: Only the devices listed above are compatible with the NetBotz wireless sensor network. Other devices will not function and may damage the appliance and other wireless devices.

The NetBotz Rack Monitor 450 appliance supports a total of **26** wireless devices on the wireless sensor network, including the Coordinator and Routers.

The NetBotz Room Monitor 455, Rack Monitor 500, and Rack Monitor 570 appliances support a total of **48** wireless devices on the wireless sensor network, including the Coordinator and Routers.



Note: A total of **26** Wireless Sensor Pod 180 devices are supported on NetBotz v4.3 appliances, including the Coordinator and Routers. The NetBotz Wireless Sensor Pod 180 is the only wireless device supported on the wireless sensor network in BotzWare v4.3 and Advanced View v4.3.

You configure the wireless sensor network in Advanced View in the following order:

- Add the extended addresses (MAC) of the wireless devices to the commission list in the *Wireless Sensor Setup* task.
- Apply the commission list to save it to the NetBotz appliance.
- Configure the Coordinator (Wireless Sensor Pod 180 only).

The order in which you configure your wireless sensor network and power your wireless devices is important.



For information about installing and configuring your wireless devices, see the installation manual that came with the NetBotz Wireless USB Coordinator & Router, NetBotz Wireless Temperature Sensor, and NetBotz Wireless Sensor Pod 180.

Add wireless devices to Advanced View. You can use a USB scanner to add the MAC addresses of your wireless devices into the “Add Addresses” dialog in the *Wireless Sensor Setup* task. Alternatively, you can save a list of MAC addresses to a text file, and copy and paste it into the dialog, one address per line, or enter the addresses manually.

Some QR code scanners return the part number, serial number, and MAC address on one line: XN:NBWC100U%SN:XXXXXX123456%MAC:**00C0B70000XXXXXX**. To add a sensor to your wireless network, enter **only** the alphanumeric MAC address of each sensor in the “Add Addresses” dialog in the Advanced View.

USB scanner. When you use a USB scanner with document capture capabilities, only the extended address (MAC) of each wireless device will appear in the list in Advanced View in the correct format.

1. Attach a hand-held USB scanner with document capture capabilities to a computer running the NetBotz Advanced View.
2. With the Advanced View open to the “Add Addresses” dialog in the *Wireless Sensor Setup* task, scan the QR code on the label of each wireless device.
3. Click **Apply Commission List** to save the list to the NetBotz appliance.

Update wireless devices. Once you have added all the wireless devices to your wireless network, you can check their current firmware revision in the *Wireless Sensor Setup* task. If an update is available, the **Firmware Update Available** button will be activated in the display.

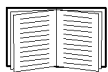

For more information about updating your wireless devices, see the *NetBotz Appliance User's Guide*.

Connect a USB modem

You can enhance the network communication capabilities of your appliance by connecting a supported USB modem to your appliance. The following USB modems are supported for use with the appliance:

- MultiTech® MultiModem® GPRS
- MultiTech MultiMobile™ USB
- MultiTech MultiModem Cell
- MultiTech MultiModem Cell 3G MTCBA-H5
- MultiTech MultiModem iCell 3G MTCMR-H5
- Option GlobeSurfer® iCon

Connect the USB modem to your appliance, or to a USB hub that is connected to the appliance. Once the modem is recognized as a serial port by the appliance, use the Advanced View *Serial Devices* task to specify the modem that is associated with the serial port. Once you specify the modem model, use the Advanced View *PPP/Modem* task to configure your appliance for PPP communications.

To uninstall your USB modem, use the *Serial Devices* task in the Advanced View to remove the device.

Connect a USB digital I/O device

You can increase the number of dry contact sensors that can be connected to your appliance by connecting a supported USB digital I/O device to your appliance. The following USB digital I/O devices are supported for use with the appliance:

- Sealevel® SeaLINK PIO-48 (adds 48 digital I/O connections)
- Sealevel Seal/O 462U (adds 96 digital I/O connections)
- Sealevel Seal/O 463U (adds 96 digital I/O connections)
- Sealevel Seal/O 450U (adds 16 digital I/O connections)

To connect a USB digital I/O device to your appliance:

1. Remove power from the appliance.
2. Connect the USB digital I/O device to your appliance, or to a USB hub that is connected to the appliance.
3. Apply power to the appliance.
4. Once the appliance has finished booting up, power for the digital I/O device will be recognized as a serial port by the appliance. Use the Advanced View *Serial Devices* task to specify the digital I/O device that is associated with the serial port.
5. Use the Advanced View *Dry Contacts* task to configure any dry contact sensors you have connected to your digital I/O device.

To uninstall your USB digital I/O device, use the *Serial Devices* task in the Advanced View to remove the device.

Connect an APC Switched Rack PDU

To connect an APC Switched Rack PDU to your appliance, use a USB-to-serial cable (NBAC0226, available from NetBotz and NetBotz resellers) to add serial ports to your appliance. Connect your USB-to-serial cable to your appliance, or to a USB hub that is connected to the appliance.



Note: The serial port connector on the USB-to-serial port converter cable is a male connector. If the Rack PDU you are connecting to the cable also has a male connector you will need a female-to-female connector null modem cable or converter block to connect the device to the USB-to-serial cable.

Once you connect the USB-to-serial cable to your appliance, you can connect the Rack PDU to the cable for use with your appliance.

Supported APC Switched Rack PDUs. APC Switched Rack PDUs with firmware version 2.74 and lower are supported at this time.

Install intelligent power strips. Connect the intelligent power strip to a serial port on your USB-to-serial cable. Use the Advanced View *Serial Devices* task to specify which serial port-based sensor you have connected to the appliance.

The sensor readings associated with the device will appear in the web client and Advanced Views once you complete installation.

To uninstall your intelligent power strip, use the Serial Devices task in the Advanced View to remove the device.

Connect external sensors

To install an external sensor, plug the sensor into an available External Port on any Sensor Pod 150, Sensor Pod 155, or Sensor Pod 120.



Note: When connecting a sensor to a Sensor Pod 120, be sure to note both the sensor pod serial number, located on the back of the pod, and the number of the External Port on the pod when you connect the cable. You will need this information when you use the sensor pod task to configure your appliance. The External Port number is printed above the port on the pod.

The female connectors on the NetBotz 120 Sensor Pod units are Version 2, NetBotz DIN standard connectors and can only accept male, Version 2, NetBotz DIN Sensor Cables. The new Version 3 products use standard RJ-45 connectors.

If the external sensor cable is not long enough, use an Extension Cable for External Sensors, available in 15 m (50 ft) and 30 m (100 ft) lengths from your NetBotz reseller, to lengthen the cable.

When you have finished installing external sensors, use the Sensor Pods task to configure the appliance to use the external sensor. Once you configure your appliance, an additional temperature sensor appears in the Sensor Data pane when the pod to which it is connected is selected from the Navigation pane. Use the Advanced View *Sensor Pods* task to specify thresholds for this external sensor.

Disposal



Warning: NetBotz Rack Monitor appliances contain non-replaceable, lithium coin-cell batteries. Do not attempt to replace the battery. Please take the battery into consideration when disposing of the appliance.

Clean the NetBotz 450/550/570

To clean the device, gently wipe surfaces with a clean, dry cloth.

Specifications

Electrical

Input voltage, nominal	100–240 VAC; 50/60 Hz
Maximum total current draw	
Rack Monitor 450/550	1A
Rack Monitor 570	2A

Physical

Dimensions (H x W x D)	43.5 x 432.0 x 93.0 mm (1.7 x 17.0 x 3.7 in)
Weight	
Rack Monitor 450/550	1.40 kg (3.09 lb)
Rack Monitor 570	1.47 kg (3.24 lb)

Environmental

Elevation (above MSL)	
Operating	0 to 3000 m (0 to 10,000 ft)
Storage	0 to 15 000 m (0 to 50,000 ft)
Temperature	
Operating	0 to 40°C (32 to 104°F)
Storage	–15 to 65°C (5 to 149°F)
Humidity	
Operating	0 to 95%, non-condensing
Storage	0 to 95%, non-condensing

Output Voltages

Voltages	12 VDC or 24 VDC
Current	75 mA total for 12 V and 24 V load
A-Link 24V (Rack Monitor 450/550)	560 mA
A-Link 24V (Rack Monitor 570)	1000 mA

Compliance

Immunity/Emissions	CE, C-UL tested to CSA C22.2 No. 60950-1-3, UL 60950-1, FCC Part 15 Class A, ICES-003 Class A, VCCI Class A, EN 55022 Class A, EN 55024, EN 61000-3-2, EN 61000-3-3, AS/NZS CISPR 22, VDE tested to EN 60950–1
--------------------	--

Sensor Specifications

Temperature Sensor(AP9335T)

Temperature accuracy	$\pm 3^{\circ}\text{F}$ ($\pm 2^{\circ}\text{C}$), from 32 to 104°F (0 to 40°C)
Sensor operating temperature	14 to 159°F (-10 to 70°C)
Maximum length of cable	50 ft (15.2 m)

Temperature/Humidity (AP9335TH)

Temperature accuracy	$\pm 3^{\circ}\text{F}$ ($\pm 2^{\circ}\text{C}$), from 32 to 104°F (0 to 40°C)
Humidity accuracy	$\pm 4\%$ RH, 20 to 90% RH, at 77°F (25°C) $\pm 8\%$ RH, 30 to 80% RH, from 59 to 95°F (15 to 30°C)
Sensor operating temperature	14 to 159°F (-10 to 70°C)
User input response time	200 mS
Maximum length of cable	50 ft (15.2 m)

Warranty

Two-Year Factory Warranty

This warranty applies only to the products you purchase for your use in accordance with this manual.

Terms of warranty

APC warrants its products to be free from defects in materials and workmanship for a period of two years from the date of purchase. APC will repair or replace defective products covered by this warranty. This warranty does not apply to equipment that has been damaged by accident, negligence or misapplication or has been altered or modified in any way. Repair or replacement of a defective product or part thereof does not extend the original warranty period. Any parts furnished under this warranty may be new or factory-remanufactured.

Non-transferable warranty

This warranty extends only to the original purchaser who must have properly registered the product. The product may be registered at the APC Web site, www.apc.com.

Exclusions

APC shall not be liable under the warranty if its testing and examination disclose that the alleged defect in the product does not exist or was caused by end user's or any third person's misuse, negligence, improper installation or testing. Further, APC shall not be liable under the warranty for unauthorized attempts to repair or modify wrong or inadequate electrical voltage or connection, inappropriate on-site operation conditions, corrosive atmosphere, repair, installation, exposure to the elements, Acts of God, fire, theft, or installation contrary to APC recommendations or specifications or in any event if the APC serial number has been altered, defaced, or removed, or any other cause beyond the range of the intended use.

THERE ARE NO WARRANTIES, EXPRESS OR IMPLIED, BY OPERATION OF LAW OR OTHERWISE, OF PRODUCTS SOLD, SERVICED OR FURNISHED UNDER THIS AGREEMENT OR IN CONNECTION HEREWITH. APC DISCLAIMS ALL IMPLIED WARRANTIES OF MERCHANTABILITY, SATISFACTION AND FITNESS FOR A PARTICULAR PURPOSE. APC EXPRESS WARRANTIES WILL NOT BE ENLARGED, DIMINISHED, OR AFFECTED BY AND NO OBLIGATION OR LIABILITY WILL ARISE OUT OF, APC RENDERING OF TECHNICAL OR OTHER ADVICE OR SERVICE IN CONNECTION WITH THE PRODUCTS. THE FOREGOING WARRANTIES AND REMEDIES ARE EXCLUSIVE AND IN LIEU OF ALL OTHER WARRANTIES AND REMEDIES. THE WARRANTIES SET FORTH ABOVE CONSTITUTE APC'S SOLE LIABILITY AND PURCHASER'S EXCLUSIVE REMEDY FOR ANY BREACH OF SUCH WARRANTIES. APC WARRANTIES EXTEND ONLY TO PURCHASER AND ARE NOT EXTENDED TO ANY THIRD PARTIES.

IN NO EVENT SHALL APC, ITS OFFICERS, DIRECTORS, AFFILIATES OR EMPLOYEES BE LIABLE FOR ANY FORM OF INDIRECT, SPECIAL, CONSEQUENTIAL OR PUNITIVE DAMAGES, ARISING OUT OF THE USE, SERVICE OR INSTALLATION, OF THE PRODUCTS, WHETHER SUCH DAMAGES ARISE IN CONTRACT OR TORT, IRRESPECTIVE OF FAULT, NEGLIGENCE OR STRICT LIABILITY OR WHETHER APC HAS BEEN ADVISED IN ADVANCE OF THE POSSIBILITY OF SUCH DAMAGES. SPECIFICALLY, APC IS NOT LIABLE FOR ANY COSTS, SUCH AS LOST PROFITS OR REVENUE, LOSS OF EQUIPMENT, LOSS OF USE OF EQUIPMENT, LOSS OF SOFTWARE, LOSS OF DATA, COSTS OF SUBSTITUENTS, CLAIMS BY THIRD PARTIES, OR OTHERWISE.

NO SALESMAN, EMPLOYEE OR AGENT OF APC IS AUTHORIZED TO ADD TO OR VARY THE TERMS OF THIS WARRANTY. WARRANTY TERMS MAY BE MODIFIED, IF AT ALL, ONLY IN WRITING SIGNED BY AN APC OFFICER AND LEGAL DEPARTMENT.

Warranty claims

Customers with warranty claims issues may access the APC customer support network through the Support page of the APC Web site, www.apc.com/support. Select your country from the country selection pull-down menu at the top of the Web page. Select the Support tab to obtain contact information for customer support in your region.

Radio Frequency Interference



Changes or modifications to this unit not expressly approved by the party responsible for compliance could void the user's authority to operate this equipment.

USA—FCC

This equipment has been tested and found to comply with the limits for a Class A digital device, pursuant to part 15 of the FCC Rules. These limits are designed to provide reasonable protection against harmful interference when the equipment is operated in a commercial environment. This equipment generates, uses, and can radiate radio frequency energy and, if not installed and used in accordance with this user manual, may cause harmful interference to radio communications. Operation of this equipment in a residential area is likely to cause harmful interference. The user will bear sole responsibility for correcting such interference.

After an electrostatic discharge (ESD) event, the appliance may require up to 2 minutes to restart services that are necessary for normal operation. During this time, the Web interface of the appliance will be unavailable. If any necessary services or devices external to the appliance, such as a DHCP server, were affected by the ESD event, these devices also need to restart properly.

Canada—ICES

This Class A digital apparatus complies with Canadian ICES-003.

Cet appareil numérique de la classe A est conforme à la norme NMB-003 du Canada.

Japan—VCCI

This is a Class A product based on the standard of the Voluntary Control Council for Interference by Information Technology Equipment (VCCI). If this equipment is used in a domestic environment, radio disturbance may occur, in which case, the user may be required to take corrective actions.

この装置は、情報処理装置等電波障害自主規制協議会（VCCI）の基準に基づくクラス A 情報技術装置です。この装置を家庭環境で使用すると、電波妨害を引き起こすことがあります。この場合には、使用者が適切な対策を講ずるよう要求されることがあります。

Taiwan—BSMI

警告使用者：

這是甲類的資訊產品，在居住的環境中使用時，可能會造成射頻干擾，在這種情況下，使用者會被要求採取某些適當的對策。

Australia and New Zealand

Attention: This is a Class A product. In a domestic environment this product may cause radio interference in which case the user may be required to take adequate measures.

European Union

This product is in conformity with the protection requirements of EU Council Directive 2004/108/EC on the approximation of the laws of the Member States relating to electromagnetic compatibility. APC cannot accept responsibility for any failure to satisfy the protection requirements resulting from an unapproved modification of the product.

This product has been tested and found to comply with the limits for Class A Information Technology Equipment according to CISPR 22/European Standard EN 55022. The limits for Class A equipment were derived for commercial and industrial environments to provide a reasonable protection against interference with licensed communication equipment.

Attention: This is a Class A product. In a domestic environment this product may cause radio interference in which case the user may be required to take adequate measures.

Schneider Electric IT Worldwide

Customer Support

Customer support for this product is available at no charge in any of the following ways:

- Visit the SEIT web site to access documents in the Knowledge Base and to submit customer support requests.
 - **www.apc.com**
Connect to localized web sites for specific countries, each of which provides customer support information.
 - **www.apc.com/support/**
Global support searching the Knowledge Base and using e-support.
- Contact the Customer Care Center by telephone or e-mail.
 - Local, country-specific centers: go to **www.apc.com/support/contact** for contact information.

For information on how to obtain local customer support, contact the Schneider Electric representative or other distributors from whom you purchased your Schneider Electric product.

© 2014 Schneider Electric. APC, the APC logo, InfraStruXure, NetBotz, and NetShelter are owned by Schneider Electric Industries S.A.S., American Power Conversion Corporation, or their affiliated companies. All other trademarks are property of their respective owners.